



LEISTUNGSERKLÄRUNG



DoP: 0097

für fischer RebarConnect (Verbundanker für die Verwendung in Beton) – DE

1. Eindeutiger Kenncode des Produkttyps: **DoP: 0097**
2. Verwendungszweck(e): **Nachträgliche Befestigung im gerissenen und ungerissenen Beton, siehe Anhang, insbesondere Anhänge B 1 bis B 6**
3. Hersteller: **fischerwerke GmbH & Co. KG, Otto-Hahn-Straße 15, 79211 Denzlingen, Deutschland**
4. Bevollmächtigter: --
5. System(e) zur Bewertung und Überprüfung der Leistungsbeständigkeit: **1**
6. Europäisches Bewertungsdokument: **ETAG 001; 2013-04**
Europäische Technische Bewertung: **ETA-16/0908; 2017-04-03**
Technische Bewertungsstelle: **DIBt**
Notifizierte Stelle(n): **1343 – MPA Darmstadt**
7. Erklärte Leistung(en):

Mechanische Festigkeit und Standsicherheit (BWR 1) , Sicherheit bei der Nutzung (BWR 4)

- **Charakteristische Werte unter statischen und quasi-statischen Einwirkungen für Bemessung nach TR 029 oder CEN/TS 1992-4:2009, Verschiebungen: Siehe Anhang, insbesondere Anhänge C 1 bis C 5**
- **Seismische Leistungskategorie C1 für Bemessung gemäß Technical Report TR 045, Verschiebungen: Siehe Anhang, insbesondere Anhänge C 1 bis C 5**

Brandschutz (BWR 2)

- **Brandverhalten: Der Dübel erfüllt die Anforderungen der Klasse A 1**
- **Feuerwiderstand: KLF**

8. Angemessene Technische Dokumentation und/oder Spezifische Technische Dokumentation: ---

Die Leistung des vorstehenden Produkts entspricht der erklärten Leistung/den erklärten Leistungen. Für die Erstellung der Leistungserklärung im Einklang mit der Verordnung (EU) Nr. 305/2011 ist allein der obengenannte Hersteller verantwortlich.

Unterzeichnet für den Hersteller und im Namen des Herstellers von:

Andreas Bucher, Dipl.-Ing.

Wolfgang Hengesbach, Dipl.-Ing., Dipl.-Wirtsch.-Ing.

i.V. A. Bucher

i.V. W. Hengesbach

Tumlingen, 2017-04-10

- Diese Leistungserklärung wurde in verschiedenen Sprachversionen erstellt. Für den Fall unterschiedlicher Auslegung hat immer die englische Version Vorrang.
- Der Anhang enthält freiwillige und ergänzende Informationen in englischer Sprache. Diese gehen über die (sprachneutral angegebenen) gesetzlichen Anforderungen hinaus.

Specific Part

1 Technical description of the product

The fischer RebarConnect is a bonded anchor for use in concrete consisting of a cartridge with injection mortar fischer FIS RC and a reinforcing bar.

The reinforcing bar is placed into a drilled hole filled with injection mortar and is anchored via the bond between metal part, injection mortar and concrete.

The product description is given in Annex A.

2 Specification of the intended use in accordance with the applicable European Assessment Document

The performances given in Section 3 are only valid if the anchor is used in compliance with the specifications and conditions given in Annex B.

The verifications and assessment methods on which this European Technical Assessment is based lead to the assumption of a working life of the anchor of at least 50 years. The indications given on the working life cannot be interpreted as a guarantee given by the producer, but are to be regarded only as a means for choosing the right products in relation to the expected economically reasonable working life of the works.

3 Performance of the product and references to the methods used for its assessment

3.1 Mechanical resistance and stability (BWR 1)

Essential characteristic	Performance
Characteristic values under static and quasi-static action for design according to TR 029 or CEN/TS 1992-4:2009, Displacements; Seismic performance category C1 for design according to Technical Report TR 045, Displacements	See Annex C 1 to C 5

3.2 Safety in case of fire (BWR 2)

Essential characteristic	Performance
Reaction to fire	Anchorage satisfy requirements for Class A1
Resistance to fire	No performance assessed

3.3 Hygiene, health and the environment (BWR 3)

Regarding dangerous substances there may be requirements (e.g. transposed European legislation and national laws, regulations and administrative provisions) applicable to the products falling within the scope of this European Technical Assessment. In order to meet the provisions of Regulation (EU) No 305/2011, these requirements need also to be complied with, when and where they apply.

3.4 Safety in use (BWR 4)

The essential characteristics regarding Safety in use are included under the Basic Works Requirement Mechanical resistance and stability.

4 Assessment and verification of constancy of performance (AVCP) system applied, with reference to its legal base

In accordance with guideline for European technical approval ETAG 001, April 2013 used as European Assessment Document (EAD) according to Article 66 Paragraph 3 of Regulation (EU) No 305/2011 the applicable European legal act is: [96/582/EC].

The system to be applied is: 1

Installation conditions

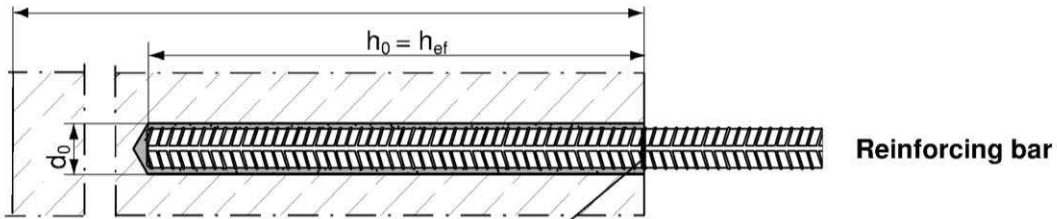

Product description

Injection system FIS RC

Cartridge sizes
(390 ml, 585 ml, 1100 ml, 1500 ml)

Sealing cap



Injection-adaptor



Reinforcing bar

Size: $\phi 8$, $\phi 10$, $\phi 12$, $\phi 14$, $\phi 16$, $\phi 20$, $\phi 25$, $\phi 28$, $\phi 32$

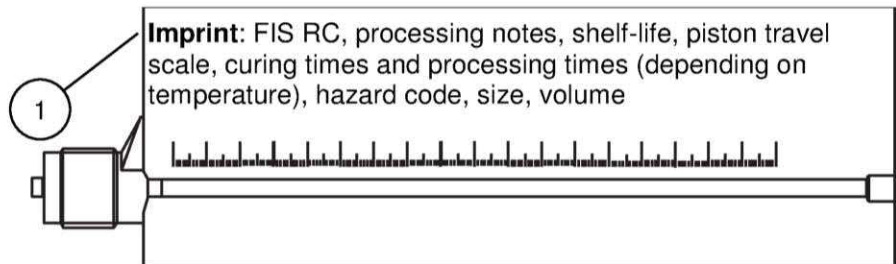

Static mixer FIS MR or FIS UMR

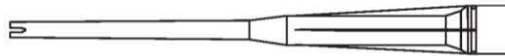

Extension tube



Table A1: Materials

Part	Designation	Material
1	Mortar cartridge	Mortar, hardener, filler
2	Reinforcing bar EN 1992-1-1:2004 and AC:2010, Annex C	Bars and de-coiled rods, class B or C with f_{yk} and k according to NDP or NCL of EN 1992-1-1/NA:2013 $f_{uk} = f_{tk} = k \cdot f_{yk}$

fischer RebarConnect



Product description

Installation conditions, cartridge, static mixer, reinforcing bar, materials

Annex A 1

Specifications of intended use (part 1)

Table B1: Overview use and performance categories injection mortar system FIS RC

Anchorage subject to	FIS RC mit ...		
	Reinforcing bar 		
Hammer drilling with standard drill bit 	all sizes		
Hammer drilling with hollow drill bit (Heller "Duster Expert" or Hilti "TE-CD, TE-YD") 	Nominal drill bit diameter (d_0) 12 mm to 35 mm		
Static and quasi static load, in	uncracked concrete	all sizes	Tables: C1, C2, C3, C4
	cracked concrete		
Seismic performance category (only hammer drilling with Standard / hollow drill bits)	C1	all sizes	Tables: C5, C6, C7
Use category	dry or wet concrete	all sizes	
Installation temperature	FIS RC: -15 °C to +40 °C		
In-service temperature	Temperature-range I	-40 °C to +40 °C	(max. long term temperature +24 °C and max. short term temperature +40 °C)
	Temperature-range II	-40 °C to +80 °C	(max. long term temperature +50 °C and max. short term temperature +80 °C)
	Temperature-range III	-40 °C to +120 °C	(max. long term temperature +72 °C and max. short term temperature +120 °C)
fischer RebarConnect		Annex B 1	
Intended Use Specifications (part 1)			

Specifications of intended use (part 2)

Base materials:

- Reinforced or unreinforced normal weight concrete from Strength classes C20/25 to C50/60 according to EN 206:2000

Design:

- Anchorages have to be designed by a responsible engineer with experience of concrete anchor design
- Verifiable calculation notes and drawings are to be prepared taking account of the loads to be anchored. The position of the anchor is indicated on the design drawings (e.g. position of the anchor relative to reinforcement or to supports, etc.)
- Anchorages under static or quasi-static actions are designed in accordance with EOTA Technical Report TR 029 "Design of bonded anchors" Edition September 2010 or CEN/TS 1992-4:2009
- Anchorages under seismic actions (cracked concrete) have to be designed in accordance with:
 - EOTA Technical Report TR 045 "Design of Metal Anchors under Seismic Action", Edition February 2013
 - Anchorages shall be positioned outside of critical regions (e.g. plastic hinges) of the concrete structure
 - Fastenings in stand-off installation or with a grout layer are not allowed

Installation:

- Anchor installation is to be carried out by appropriately qualified personnel and under the supervision of the person responsible for technical matters of the site
- In case of aborted hole: The hole shall be filled with mortar
- Anchorage depth should be marked and adhered to on installation
- Overhead installation is allowed

fischer RebarConnect

Intended Use
Specifications (part 2)

Annex B 2

Table B2: Installation parameters for reinforcing bars

Nominal diameter of the bar		ϕ	8 ¹⁾		10 ¹⁾		12 ¹⁾		14	16	20	25	28	32	
Nominal drill bit diameter	d_0	[mm]	10	12	12	14	14	16	18	20	25	30	35	40	
Drill hole depth	h_0		$h_0 = h_{ef}$												
Effective anchorage depth	$h_{ef,min}$		60	60	70	75	80	90	100	112	128				
	$h_{ef,max}$		160	200	240	280	320	400	500	560	640				
Minimum spacing and minimum edge distance	s_{min}		40	45	55	60	65	85	110	130	160				
	c_{min}														
Minimum thickness of concrete member	h_{min}	$h_{ef} + 30$ (≥ 100)				$h_{ef} + 2d_0$									

¹⁾ Both drill bit diameters can be used

Reinforcing bar

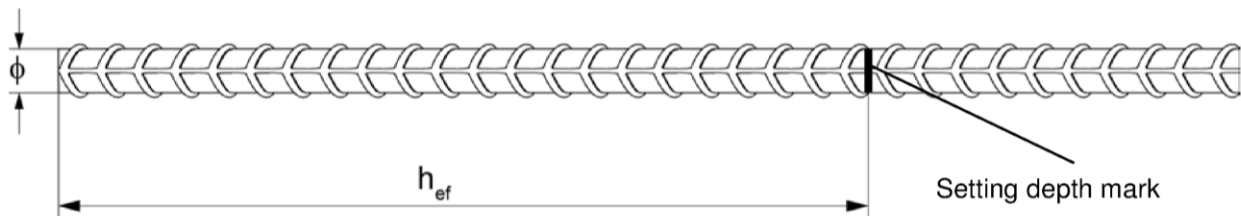

- The minimum value of related rib area $f_{R,min}$ must fulfil the requirements of EN 1992-1-1:2004+AC:2010
- The rib height must be within the range: $0,05 \cdot \phi \leq h_{rib} \leq 0,07 \cdot \phi$
(ϕ = Nominal diameter of the bar , h_{rib} = rib height)

fischer RebarConnect

Intended Use
Installation parameters reinforcing bars

Annex B 3

Table B3: Parameters of steel brush FIS BS Ø

The size from the steelbrush is according to the drill bit diameter

Drill bit diameter	d_0	[mm]	10	12	14	16	18	20	24	25	28	30	32	35	40
Steel brush diameter	d_b		11	14	16	20	25	26	27	30	40	42			

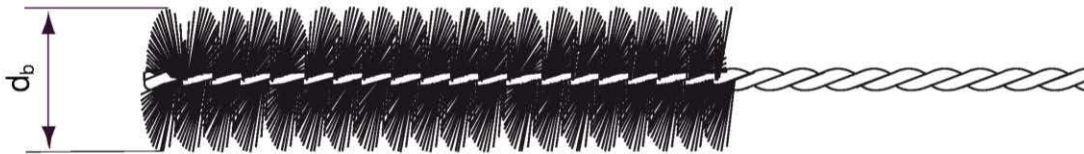

Table B4: Maximum processing time of the mortar and minimum curing time
(Minimal cartridge temperature +5 °C)

System temperature [°C]	Maximum processing time t_{work} [minutes] FIS RC	Minimum curing time ¹⁾ t_{cure} [minutes] FIS RC
> -15 bis -10	60	36 hours
> -10 bis -5	30	24 hours
> -5 bis ±0	20	8 hours
> ±0 bis +5	13	4 hours
> +5 bis +10	9	2 hours
> +10 bis +20	5	60
> +20 bis +30	4	45
> +30 bis +40	2	30





fischer RebarConnect

Intended Use
Cleaning tools
Processing times and curing times

Annex B 4

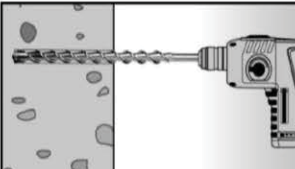
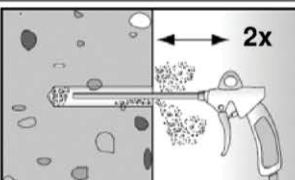
Installation instructions part 1; Injection mortar system FIS RC

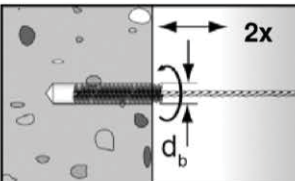
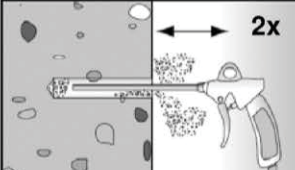
Drilling and cleaning the hole (hammer drilling with standard drill bit)

1		<p>Drill the hole. Drill hole diameter d_0 and drill hole depth h_0 see Tables B2</p>	
2		<p>Blow out the drill hole twice, with oil-free compressed air ($p \geq 6$ bar). In uncracked concrete the use of a manual blow-out pump is possible (Installation parameters: $d_0 < 18$ mm and $h_{ef} < 10d$)</p>	
3		<p>Brush the drill hole twice. For drill hole diameter ≥ 30 mm use a power drill. For deep holes use an extension. Corresponding brushes see Table B3</p>	
4		<p>Blow out the drill hole twice, with oil-free compressed air ($p \geq 6$ bar). In uncracked concrete the use of a manual blow-out pump is possible (Installation parameters: $d_0 < 18$ mm and $h_{ef} < 10d$)</p>	

Go to step 5

Drilling and cleaning the hole (hammer drilling with hollow drill bit)

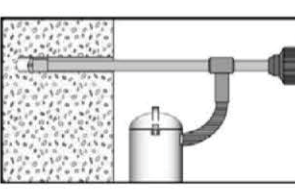
1		<p>Check a suitable hollow drill (see Annex B 1) for correct operation of the dust extraction</p>	
2		<p>Use a suitable dust extraction system, e.g. Bosch GAS 35 M AFC or a comparable dust extraction system with equivalent performance data</p> <p>Drill the hole with hollow drill bit. The dust extraction system has to extract the drill dust nonstop during the drilling process and must be adjusted to maximum power. Diameter of drill hole d_0 and drill hole depth h_0 see Tables B2.</p>	

Go to step 5



fischer RebarConnect

Intended use
Installation instructions part 1

Annex B 5

Installation instructions part 2; Injection mortar system FIS RC

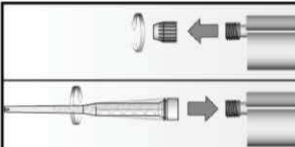
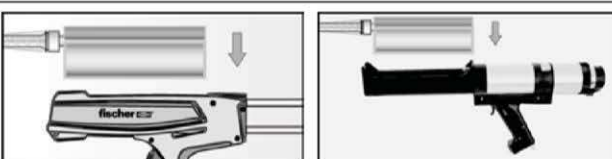

Preparing the cartridge

5		<p>Remove the sealing cap</p> <p>Screw on the static mixer (the spiral in the static mixer must be clearly visible)</p>
6		<p>Place the cartridge into the dispenser</p>
7		<p>Extrude approximately 10 cm of material until the resin is evenly grey in colour. Do not use mortar that is not uniformly grey</p>

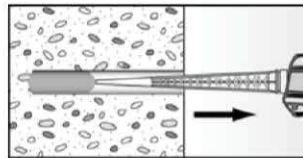
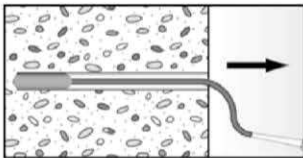
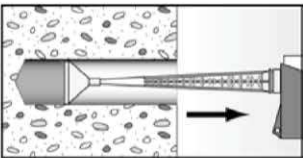
Mortar injection

8	 <p>Fill approximately 2/3 of the drill hole with mortar. Always begin from the bottom of the hole and avoid bubbles</p>	 <p>For drill hole depth ≥ 150 mm use an extension tube</p>	 <p>For overhead installation, deep holes $h_0 > 250$ mm or drill hole diameter $d_0 \geq 40$ mm use an injection-adapter</p>
---	--	---	--

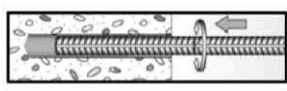
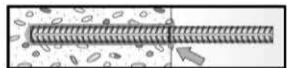
Installation reinforcing bar

9	 <p>Only use clean and oil-free reinforcing bars. Mark the setting depth. Turn while using force to push the reinforcement bar into the filled hole up to the setting depth mark</p>
	 <p>When the setting depth mark is reached, excess mortar must be emerged from the mouth of the drill hole</p>
10	 <p>Wait for the specified curing time t_{cure} see Table B4</p>

fischer RebarConnect

Intended use
Installation instructions part 2

Annex B 6

Table C1: Characteristic values for the **steel bearing capacity** under tensile / shear load of **reinforcing bars**

Nominal diameter of the bar		ϕ	8	10	12	14	16	20	25	28	32
Bearing capacity under tensile load, steel failure											
Characteristic bearing capacity	$N_{Rk,s}$	[kN]	$A_s \cdot f_{uk}^{1)}$								
Bearing capacity under shear load, steel failure											
without lever arm											
Characteristic bearing capacity	$V_{Rk,s}$	[kN]	$0,5 \cdot A_s \cdot f_{uk}^{1)}$								
Ductility factor acc. to CEN/TS 1992-4-5:2009 Section 6.3.2.1	k_2	[-]	0,8								
with lever arm											
Characteristic bending moment	$M_{Rk,s}^0$	[Nm]	$1,2 \cdot W_{el} \cdot f_{uk}^{1)}$								

¹⁾ f_{uk} or f_{yk} respectively must be taken from the specifications of the reinforcing bar

fischer RebarConnect

Performances

Characteristic steel bearing capacity of reinforcing bar

Annex C 1

Table C2: General design factors for the bearing capacity under tensile / shear load; uncracked or cracked concrete

Size		All Sizes									
Bearing capacity under tensile load											
Factors acc. to CEN/TS 1992-4:2009 Section 6.2.2.3											
Uncracked concrete	k_{ucr}	[-]	10,1								
Cracked concrete	k_{cr}		7,2								
Factors for the compressive strength of concrete > C20/25											
Increasing factor for τ_{Rk}	C25/30	Ψ_c	[-]	1,02							
	C30/37			1,04							
	C35/45			1,07							
	C40/50			1,08							
	C45/55			1,09							
	C50/60			1,10							
Splitting failure											
Edge distance	$h / h_{ef} \geq 2,0$	$C_{cr,sp}$	[mm]	1,0 h_{ef}							
	$2,0 > h / h_{ef} > 1,3$			4,6 h_{ef} - 1,8 h							
	$h / h_{ef} \leq 1,3$			2,26 h_{ef}							
Spacing	$S_{cr,sp}$			2 $C_{cr,sp}$							
Concrete cone failure acc. to CEN/TS 1992-4-5:2009 Section 6.2.3.2											
Edge distance	$C_{cr,N}$	[mm]	1,5 h_{ef}								
Spacing	$S_{cr,N}$		2 $C_{cr,N}$								
Bearing capacity under shear load											
Installation safety factors											
All installation conditions	$\gamma_2 = \gamma_{inst}$	[-]	1,0								
Concrete pry-out failure											
Factor k acc. to TR029 Section 5.2.3.3 resp. k_3 acc. to CEN/TS 1992-4-5:2009 Section 6.3.3	$k_{(3)}$	[-]	2,0								
Concrete edge failure											
The value of h_{ef} (= l_f) under shear load		[mm]	min (h_{ef} ; 8d)								
Calculation diameters											
Nominal diameter of the bar	ϕ		8	10	12	14	16	20	25	28	32
Reinforcing bar	d	[mm]	8	10	12	14	16	20	25	28	32
fischer RebarConnect										Annex C 2	
Performances General design factors relating to the characteristic bearing capacity under tensile / shear load											

Table C3: Characteristic values of **resistance** for **reinforcing bars** in hammer drilled holes in combination with **injection mortar FIS RC; uncracked or cracked concrete**

Nominal diameter of the bar ϕ		8	10	12	14	16	20	25	28	32	
Combined pullout and concrete cone failure											
Calculation diameter	d [mm]	8	10	12	14	16	20	25	28	32	
Uncracked concrete											
Characteristic bond resistance in uncracked concrete C20/25											
Hammer-drilling with standard drill bit or hollow drill bit (dry and wet concrete)											
Tem- perature range	I: 24 °C / 40 °C	$\tau_{Rk,ucr}$ [N/mm ²]	8,0	8,5	9,0	9,5	9,5	10	9,5	9,0	7,5
	II: 50 °C / 80 °C		8,0	8,5	9,0	9,0	9,5	9,5	9,0	8,5	7,5
	III: 72 °C / 120 °C		7,0	7,5	8,0	8,0	8,5	8,5	8,0	7,5	6,5
Cracked concrete											
Characteristic bond resistance in cracked concrete C20/25											
Hammer-drilling with standard drill bit or hollow drill bit (dry and wet concrete)											
Tem- perature range	I: 24 °C / 40 °C	$\tau_{Rk,cr}$ [N/mm ²]	4,5	6,0	6,0	6,0	7,0	6,0	6,0	6,0	6,0
	II: 50 °C / 80 °C		4,5	5,5	5,5	5,5	6,5	6,0	6,0	6,0	6,0
	III: 72 °C / 120 °C		4,0	5,0	5,0	5,0	6,0	5,5	5,5	5,5	5,5
Installation safety factors											
Dry and wet concrete	$\gamma_2 = \gamma_{inst}$	[-]	1,0								

fischer RebarConnect

Performances

Characteristic values for static or quasi-static action under tensile load for reinforcing bars with injection mortar FIS RC (uncracked or cracked concrete)

Annex C 3

Table C4: Displacements for reinforcing bars

Nominal diameter of the bar ϕ		8	10	12	14	16	20	25	28	32
Displacement-Factors for tensile load¹⁾										
Uncracked or cracked concrete; Temperature range I, II, III										
δ_{N0} -Factor	[mm/(N/mm ²)]	0,07	0,08	0,09	0,09	0,10	0,11	0,12	0,13	0,13
$\delta_{N\infty}$ -Factor		0,11	0,13	0,13	0,15	0,16	0,16	0,18	0,20	0,20
Displacement-Factors for shear load²⁾										
Uncracked or cracked concrete; Temperature range I, II, III										
δ_{V0} -Factor	[mm/kN]	0,18	0,15	0,12	0,10	0,09	0,07	0,06	0,05	0,05
$\delta_{V\infty}$ -Factor		0,27	0,22	0,18	0,16	0,14	0,11	0,09	0,08	0,06

¹⁾ Calculation of effective displacement:

$$\delta_{N0} = \delta_{N0\text{-Factor}} \cdot \tau_{Ed}$$

$$\delta_{N\infty} = \delta_{N\infty\text{-Factor}} \cdot \tau_{Ed}$$

(τ_{Ed} : Design value of the applied tensile stress)

²⁾ Calculation of effective displacement:

$$\delta_{V0} = \delta_{V0\text{-Factor}} \cdot V_{Ed}$$

$$\delta_{V\infty} = \delta_{V\infty\text{-Factor}} \cdot V_{Ed}$$

(V_{Ed} : Design value of the applied shear force)

Table C5: Characteristic values for the steel bearing capacity under tensile / shear load of reinforcing bars (B500B) under seismic action performance category C1

Nominal diameter of the bar ϕ		8	10	12	14	16	20	25	28	32
Bearing capacity under tensile load, steel failure¹⁾										
Reinforcing bar B500B acc. to DIN 488-2:2009-08, performance category C1										
Characteristic bearing capacity	$N_{Rk,s,C1}$ [kN]	28	44	63	85	111	173	270	339	443
Bearing capacity under shear load, steel failure without lever arm¹⁾										
Reinforcing bar B500B acc. to DIN 488-2:2009-08, performance category C1										
Characteristic bearing capacity	$V_{Rk,s,C1}$ [kN]	10	15	22	30	39	61	95	119	155

¹⁾ Partial safety factors for performance category C1 see Table C6

Table C6: Partial safety factors of reinforcing bars (B500B) under seismic action performance category C1

Nominal diameter of the bar ϕ		8	10	12	14	16	20	25	28	32
Bearing capacity under tensile load, steel failure¹⁾										
Partial safety factor	Reinforcing bar	B500B	[-]	1,40						
$\gamma_{Ms,N}$										
Bearing capacity under shear load, steel failure¹⁾										
Partial safety factor	Betonstahl	B500B	[-]	1,50						
$\gamma_{Ms,V}$										

¹⁾ In absence of other national regulations

fischer RebarConnect

Performances

Displacements for reinforcing bar, Characteristic steel bearing capacity of reinforcing bars under seismic action and partial safety factors (performance category C1)

Annex C 4

Table C7: Characteristic values of **resistance** for **reinforcing bars** in hammer drilled holes with **injection mortar FIS SB** under seismic action performance category **C1**

Nominal diameter of the bar		ϕ	8	10	12	14	16	20	25	28	32
Characteristic bond resistance, combined pullout and concrete cone failure											
Hammer-drilling with standard drill bit or hollow drill bit (dry and wet concrete)											
Tem- perature range	I: 24 °C / 40 °C	$\tau_{Rk,C1}$ [N/mm ²]	3,2	4,3	4,5	4,5	5,3	4,5	4,5	4,5	5,1
	II: 50 °C / 80 °C		3,2	3,9	4,1	4,1	4,9	4,5	4,5	4,5	5,1
	III: 72 °C / 120 °C		2,8	3,6	3,8	3,8	4,5	4,1	4,1	4,1	4,7
Installation safety factors											
Bearing capacity under tensile load											
Dry and wet concrete		$\gamma_2 = \gamma_{inst}$	[-]		1,0						
Bearing capacity under shear load											
All installation conditions		$\gamma_2 = \gamma_{inst}$	[-]		1,0						

fischer RebarConnect

Performances

Characteristic values under seismic action (performance category C1) for reinforcing bars

Annex C 5