

Art. 160.1250

KS TOOLS®

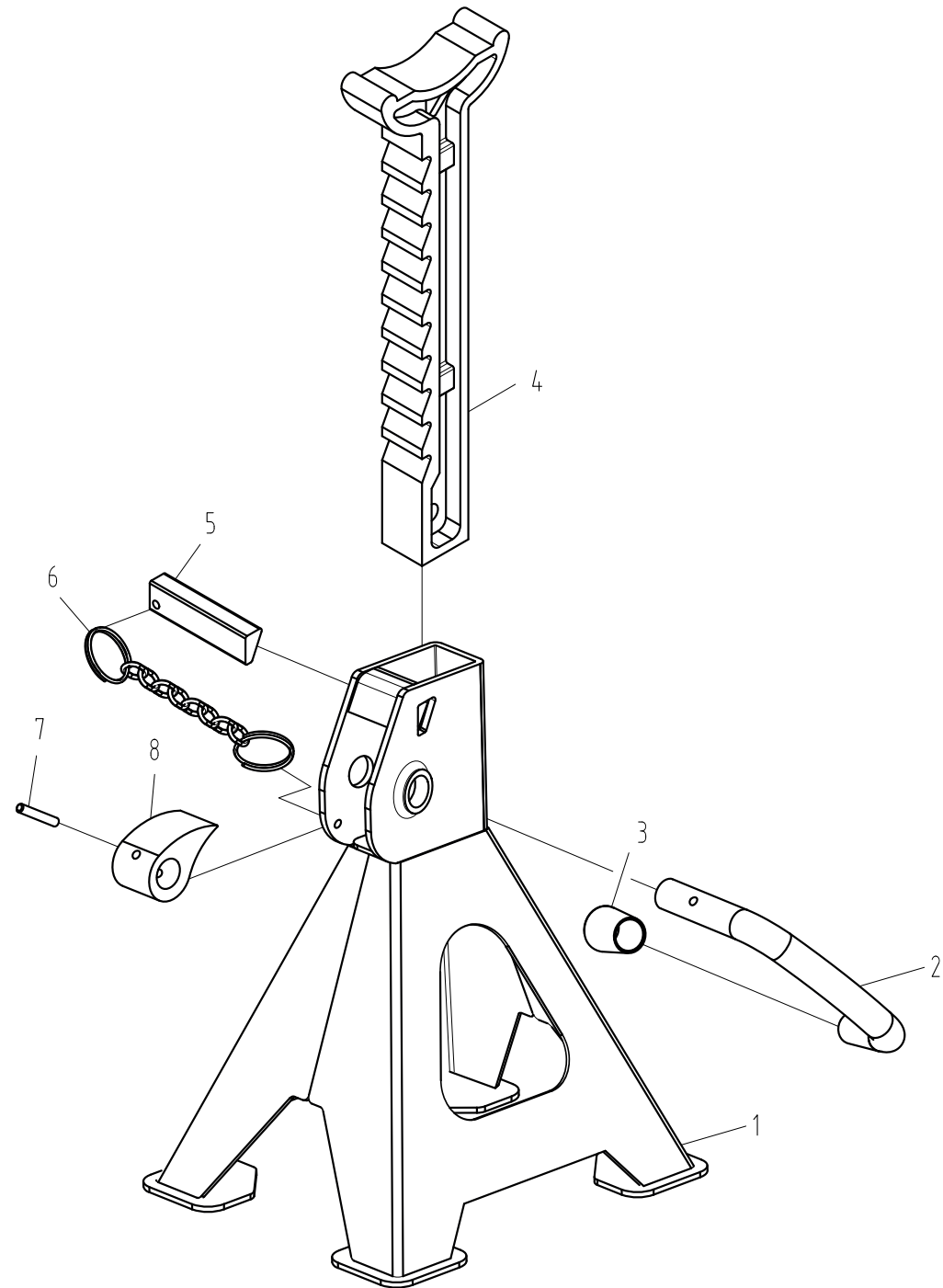

Art. 160.1250



Part. No	Art.-Nr.	Beschreibung	Description	Menge Qty.
1	160.1250-R001P	Grundgestell	Base	1
2	160.1250-R002P	Handgriff	Handle	1
3	160.1250-R003P	Gummikappe	Handle Sleeve	1
4	160.1250-R004P	Aufnahme	Support Column	1
5	160.1250-R005P	Bolzen	Pin	1
6	160.1250-R006P	Kette	Chain	1
7	160.1250-R007P	Bolzen	Pin	1
8	160.1250-R008P	Klaue	Pawl	1