

Art. 160.1115

KS TOOLS®

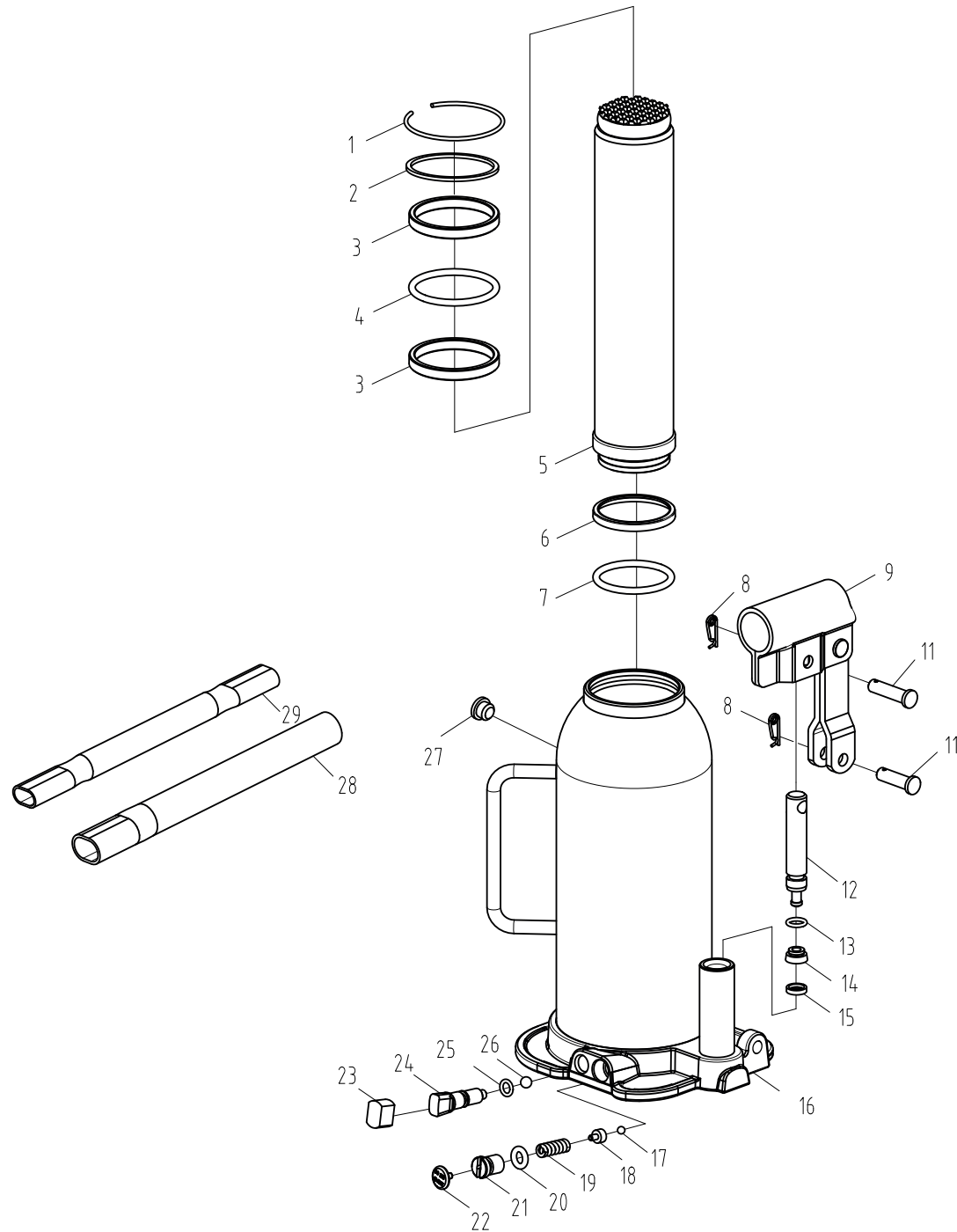

Art. 160.1115

Part. No	Art.-Nr.	Beschreibung	Description	Menge Qty.
1	160.1115-R001P	Sicherungsring	Gasket ring	1
2	160.1115-R002P	Kolbenentanschlag	Piston rod stop plate	1
3	160.1115-R003P	Sicherungsring	Gasket ring	2
4	160.1115-R004P	O-Ring	O-ring	1
5	160.1115-R005P	Hubkolben	Piston rod	1
6	160.1115-R006P	Unterlegscheibe	Washer	1
7	160.1115-R007P	O-Ring	O-ring	1
8	160.1115-R008P	Bolzen	Pin	2
9	160.1115-R009P	Lenkstangenaufnahme	Handle socket	1
11	160.1115-R010P	Bolzen	Pin	2
12	160.1115-R011P	Pumpkolben	Pump core	1
13	160.1115-R012P	O-Ring	O-ring	1
14	160.1115-R013P	Nylonring	Nylon gasket ring	1
15	160.1115-R014P	Y-Ring	Y-ring	1

Part. No	Art.-Nr.	Beschreibung	Description	Menge Qty.
16	160.1115-R015P	Grundgestell	Base	1
17	160.1115-R016P	Stahlkugel	Steel ball	1
18	160.1115-R017P	Ventilsitz	Steel ball valvt seat	1
19	160.1115-R018P	Feder	Spring	1
20	160.1115-R019P	O-Ring	O-ring	1
21	160.1115-R020P	Schraube	Screw	1
22	160.1115-R021P	Abdeckung	Cap	1
23	160.1115-R022P	Ventilschutzhülse	Oil return valve stem protective sleeve	1
24	160.1115-R023P	Ablassventil	Drain valve stem	1
25	160.1115-R024P	O-Ring	O-ring	1
26	160.1115-R025P	Stahlkugel	Steel ball	1
27	160.1115-R026P	Öl Einfüllschraube	Oil plug	1
28	160.1115-R027P	Betätigungsstange 2	Handle A	1
29	160.1115-R028P	Betätigungsstange 1	Handle B	1