

1

2

3

4

5

6

A

A

B

B

C

C

D

D

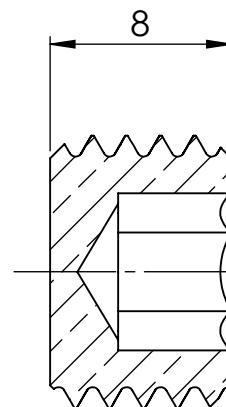
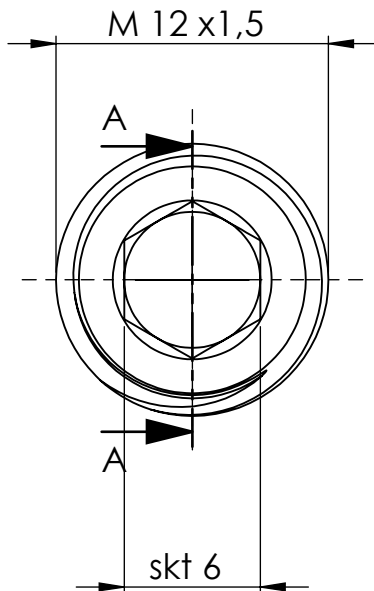

Ansicht / view A-A

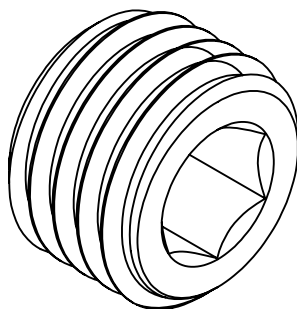

		Maßstab / Scale: 3:1	
		Material: CW 614N (CuZn39Pb3)	
		Benennung / Designation: Verschlusschraube I-Skt. o.B. locking screw, hexagonal socket, without flange	
		Artikelnummer / item number: 135988	Status
		Typ-Nr.: MS2900B12	Format A4
			Version Blatt / von sheet / of 2 / 2



1

2

3

4

5

6