

PKH.EN.M.I

11-2



PKH.EN.M.I

Robuster, pneumatisch automatisierter Messingkugelhahn in 2-teiliger Gehäusebauform.

NENNWEITEN

DN15 (1/2") bis DN80 (3")

ANSCHLUSS UND NORMEN

Beidseitiges Innengewinde nach UNI EN 10226 (DIN ISO 7/1)
 Aufbauflansch nach ISO 5211

BETRIEBSDRUCK

Von PN40 (1/4") bis PN16 (3")
 (maximal, Druck-/Temperaturdiagramm beachten!)

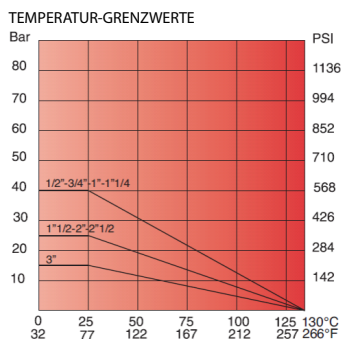

WERKSTOFFE

Gehäuse: Messing CW 617 N UNI EN 12165
 Kugel: Messing, hartverchromt CW 614 N UNI EN 12164
 Kugeldichtung: PTFE
 Schaltwelle: Messing, hartverchromt CW 614 N UNI EN 12164
 Schaltwellendichtung: PTFE
 O-Ring: Elastomer
 Stopfbuchse: Messing CW 614 N UNI EN 12164

DURCHFLUSSRICHTUNG

Beliebig

EINBAULAGE

Siehe Einbauempfehlung für Industriearmaturen

DURCHFLUSSMEDIUM

Neutrale Gase und Flüssigkeiten. Bei aggressiven Medien Werkstoffbeständigkeitstabelle beachten. Bestimmte Medien können zur Erhöhung des Betätigungsmomentes führen.

BETÄTIGUNG (Standard)

Mit pneumatischem Schenkantrieb in doppelt- oder einfachwirkender (Federkraft öffnend oder schließend) Ausführung.

STEUERMEDIUM

Gefilterte Luft nach PNEUROP/ISO Klasse 4, weitere Medien auf Anfrage.

STEUERDRUCK

5,5 bar, weitere auf Anfrage.

UMGEBUNGSTEMPERATUR SCHWENKANTRIEB

-50°C bis +70°C, weitere auf Anfrage

PNEUMATISCHE ANSTEUERUNG

Optional je nach Ausführung mittels 3/2- oder 5/2-Wegeventil oder Stellschaltregler mit NAMUR-Anschluß.

OPTIONSBAUGRUPPEN UND ZUBEHÖR

Mechanischen Endlagenschaltern oder induktiven Endlagensensoren in offener oder geschlossener (Signalbox) Aufbauweise.

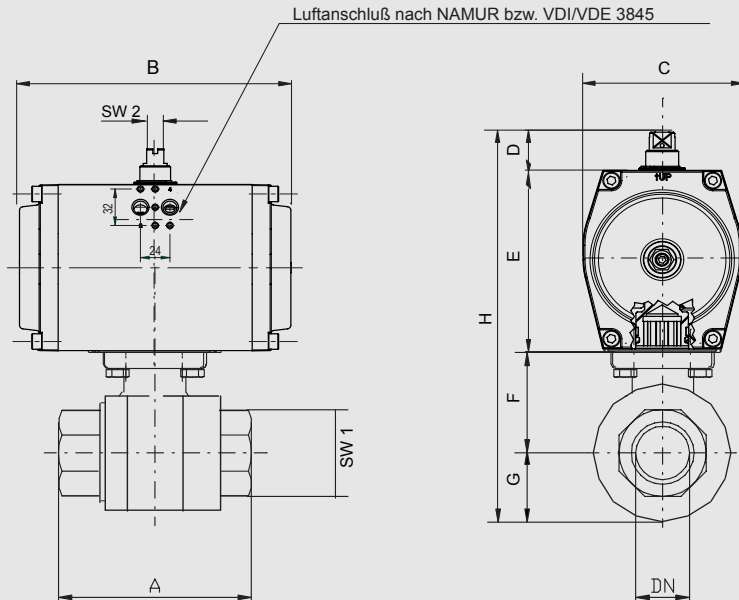

PKH.EN.M.I	Nennweite [mm] Anschluss [mm]		max. Druck [bar] PN	M(1) + 30% [Nm]	Flansch	4-Kant	Pneumatischer Stellantrieb	Baumaße [mm] und Gewichte [kg]										Artikel Nr.	Ident Nr.	
	DN	Rp						A	B	C	D	E	F	G	H	SW 1	SW 2			Gew.
doppeltwirkend - L-Bohrung	15	1/2"	40	4,2	F03	9	GTKB.52x90	75	133	68,5	30	74	38	17	159	26	10	1,30	350.210	103521
	15	1/2"	40	4,2	F03	9	GTKB.43x90	75	116	61,5	30	65	38	17	150	26	10	1,00	350.210/1	103522
	20	3/4"	40	5,6	F03	9	GTKB.52x90	80	133	68,5	30	74	40,5	20	164,5	32	10	1,40	350.211	103523
	20	3/4"	40	5,6	F03	9	GTKB.43x90	80	116	61,5	30	65	40,5	20	155,5	32	10	1,10	350.211/1	103524
	25	1"	40	8,4	F03/F04	9	GTKB.52x90	90	133	68,5	30	74	44	25	173	41	10	1,70	350.212	103525
	25	1"	40	8,4	F03/F04	9	GTKB.43x90	90	116	61,5	30	65	44	25	164	41	10	1,40	350.212/1	103526
	32	1 1/4"	40	9,8	F04/F05	11	GTKB.44x90	110	116	61,5	30	65	55	30	180	50	10	1,70	350.213	103527
	40	1 1/2"	25	13	F04/F05	11	GTKB.52x90	120	133	68,5	30	74	61,5	36	201,5	55	10	2,60	350.214	103528
	50	2"	25	25	F05	14	GTKB.63x90	140	137	80	30	88	73	45	236	70	10	4,45	350.215	103529
65	2 1/2"	25	38	F07	14	GTKB.75x90	155	161	92,5	30	100	82,8	57	269,8	83	10	5,50	350.216	103530	
80	3"	16	46	F07	14	GTKB.75x90	182	161	92,5	30	100	94,5	68	292,5	98	10	8,20	350.217	103531	
einfachwirkend - federschließend	15	1/2"	40	4,2	F03	9	GTKB.52x90.08	75	133	68,5	30	74	38	17	159	26	10	1,40	350.310	103532
	20	3/4"	40	5,6	F03	9	GTKB.52x90.08	80	133	68,5	30	74	40,5	20	164,5	32	10	1,50	350.311	103533
	25	1"	40	8,4	F03/F04	9	GTKB.52x90.08	90	133	68,5	30	74	44	25	173	41	10	1,80	350.312	103534
	32	1 1/4"	40	9,8	F04/F05	11	GTKB.63x90.08	110	137	80	30	88	55	30	203	50	10	2,90	350.313	103535
	40	1 1/2"	25	13	F04/F05	11	GTKB.63x90.08	120	137	80	30	88	61,5	36	215,5	55	10	3,30	350.314	103536
	50	2"	25	25	F05	14	GTKB.83x90.08	140	180	92,5	30	100	73	45	248	70	10	6,00	350.315	103537
	65	2 1/2"	25	38	F07	14	GTKB.92x90.10	155	209	110,5	30	117	82,8	57	286,8	83	14	7,40	350.316	103538
	80	3"	16	46	F07	14	GTKB.92x90.10	182	209	110,5	30	117	94,5	68	309,5	98	14	10,5	350.317	103539
einfachwirkend - federöffnend	15	1/2"	40	4,2	F03	9	GTKB.52x90.08	75	133	68,5	30	74	38	17	159	26	10	1,40	350.410	103540
	15	1/2"	40	4,2	F03	9	GTKB.43x90.10	75	116	61,5	30	65	38	17	150	26	10	1,20	350.410/1	103541
	20	3/4"	40	5,6	F03	9	GTKB.52x90.08	80	133	68,5	30	74	40,5	20	164,5	32	10	1,50	350.411	103542
	25	1"	40	8,4	F03/F04	9	GTKB.52x90.08	90	133	68,5	30	74	44	25	173	41	10	1,80	350.412	103543
	32	1 1/4"	40	9,8	F04/F05	11	GTKB.63x90.08	110	137	80	30	88	55	30	203	50	10	2,90	350.413	103544
	40	1 1/2"	25	13	F04/F05	11	GTKB.63x90.08	120	137	80	30	88	61,5	36	215,5	55	10	3,30	350.414	103545
	50	2"	25	25	F05	14	GTKB.83x90.08	140	180	92,5	30	100	73	45	248	70	10	6,00	350.415	103546
	65	2 1/2"	25	38	F07	14	GTKB.92x90.10	155	209	110,5	30	117	82,8	57	286,8	83	14	7,40	350.416	103547
80	3"	16	46	F07	14	GTKB.92x90.10	182	209	110,5	30	117	94,5	68	309,5	98	14	10,5	350.417	103548	

(1) = Losbrechmoment der Armatur inklusive Sicherheitszuschlag 30%. (2) = SW Angabe in mm

Riegler & Co. KG

 Abteilung ZeDok, Tel. 07125/949741, 949742, 949753, Fax.: 07125/949799, email: zedok@riegler.de
 Schützenstraße 27, D-72574 Bad Urach

Werkstoffe - pnematische Stellantriebe Typ GTK, GTX, GTW materials - pneumatic actuators type GTK, GTX, GTW

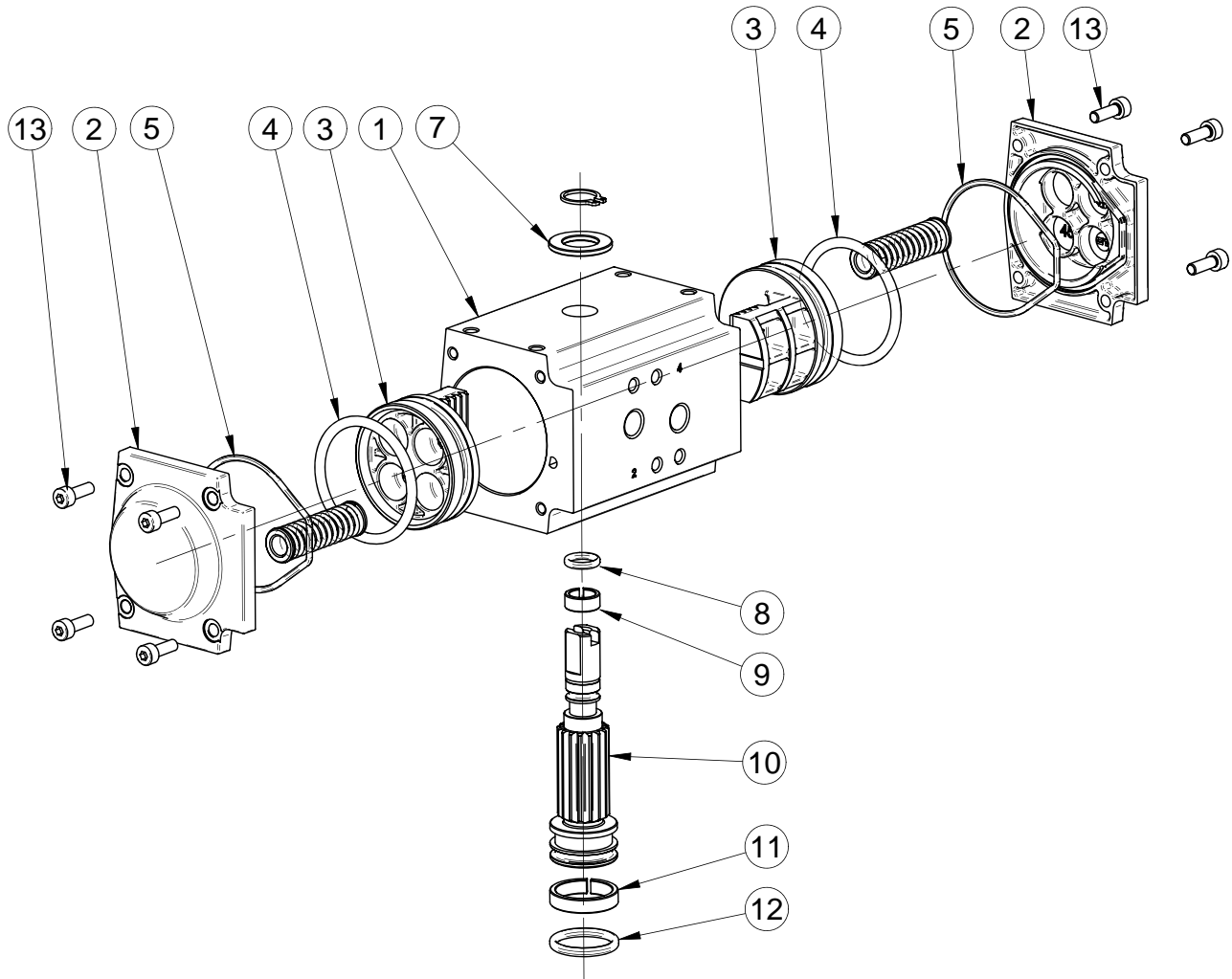



























WERKSTOFFTABELLE

Typ	Beschreibung	Material
Standard-Ausführung	Gehäuse (1)	Extrudierte Aluminium Legierung AL MG Si 0,5 F28, ASTM 6063, eloxiert
	Seitendeckel (2)	Aluminium Legierung Gd-Al Si 12 Cu 2 Fe, epoxydharzbeschichtet, Farbe RAL 5015 (blau)
	Kolben (3)	Aluminium Legierung Gd-Al Si 12 Cu 2 Fe
	O-Ringe (5, 8, 12)	NBR 70 SH (Perbunan)
	Lagerungen, Gleitelemente (4, 7, 9, 11)	Delrin ISO 9988
	Ritzel (10)	Stahl 11SMBPB37, hartvernickelt
	Schrauben (13)	Edelstahl AISI 304
Chemie-Ausführung	Gehäuse (1)	Extrudierte Aluminium-Legierung (Al Mg Si 0,5 F28), hartanodisiert und teflonisiert
	Seitendeckel (2)	Aluminium-Legierung (Gd-AL Si 12 Cu 2 F2), epoxydharzbeschichtet, Farbe RAL 5015 (blau)
	Kolben (3)	Aluminium-Legierung (Gd-Al Si 12 Cu 2 Fe)
	O-Ringe (5, 8, 12)	Nitrilkautschuk - NBR (Perbunan)
	Lagerungen, Gleitelemente (4, 7, 9, 11)	Delrin ISO 9988
	Ritzel (10)	Edelstahl AISI 303
	Schrauben (13)	Edelstahl AISI 304

MATERIAL LIST

type	description	materials
standard version	Body (1)	Extruded aluminium alloy astm 6063 anodized 10681
	End caps (2)	Die-cast aluminium alloy EN AC-46100 UNI EN 1706:1999, color RAL 5015 (blue)
	Piston (3)	Die-cast aluminium alloy EN AC-46100 UNI EN 1706:1999
	O-Ring (5, 8, 12)	NBR 70 SH (Perbunan)
	Guide set (4, 7, 9, 11)	DELRIN ISO 9988
	Pinion (10)	Steel 11SMNBP37, electroless nickel plated
	Screws (13)	Stainless steel AISI 304
chemical version	Body (1)	Extruded aluminium alloy astm 6063 anodized 10681, hardcoated and teflon
	End caps (2)	Die-cast aluminium alloy EN AC-46100 UNI EN 1706:1999, color RAL 5015 (blue)
	Pistons (3)	Die-cast aluminium alloy EN AC-46100 UNI EN 1706:1999
	O-Ring (5, 8, 12)	NBR 70 SH (Perbunan)
	Guide set (4, 7, 9, 11)	DELRIN ISO 9988
	Pinion (10)	Stainless steel AISI 304
	Screws (13)	Stainless steel AISI 304

Schaltstellungen 3-Wege-Kugelhähne mit pneumatischen Stellantrieb			
Variante	Grundstellung 0°	Dreh- richtung	Schaltstellung 90°
L1			
L2			
T1			
T2			
T3			
T4			
T5			
T6			
T7			
T8	