

P35

workshop tool trolley
with 279 tools for 5 drawers
835.5279

INNOVATIVE THINKING FOR GREATER EFFICIENCY!



Workshop trolley P35
with 12 compartments
873.5008



DUO Lock Brilliant locking system



Twelve drawers each load capacity up to 50 kg



Stable **ball bearing**



Stainless steel surface

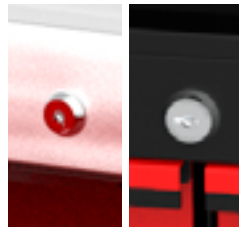

Two locks lockable

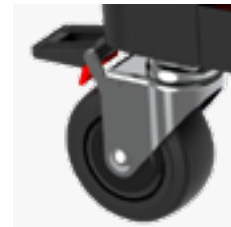

Anti-static castors with brakes



Integrated **corner protection**



Paper roll holder included



Can holder included

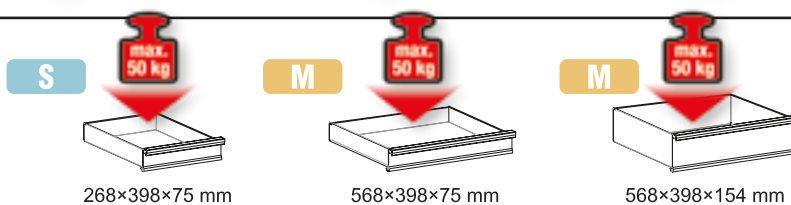

268×398×75 mm

568×398×75 mm

568×398×154 mm

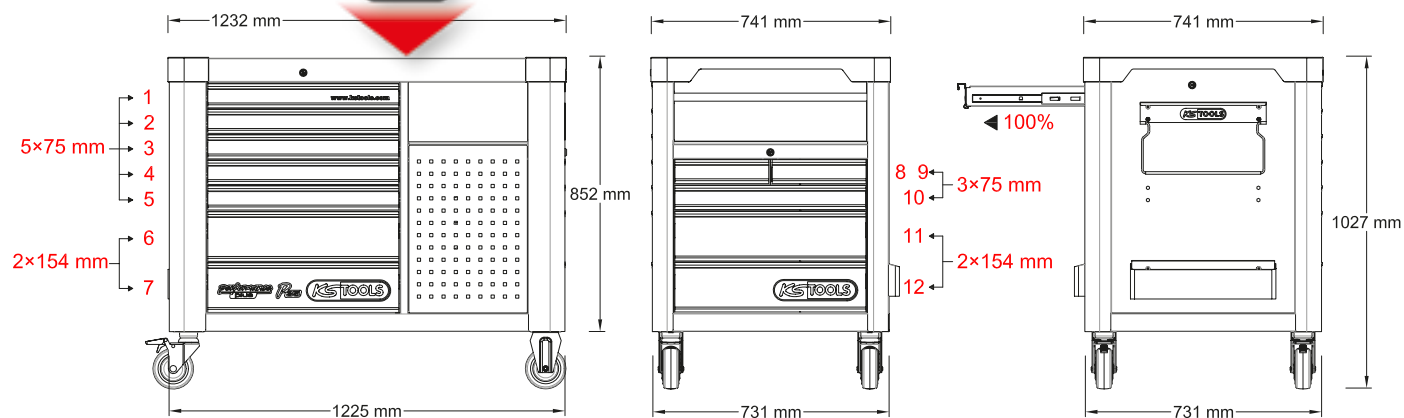

P35 workshop tool trolley set with 279 tools for 5 drawers

835.5279



M

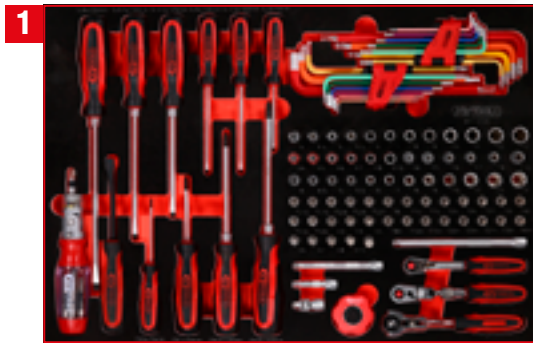

1/4" socket spanner and screwdriver set in foam insert

811.0105



3/8" + 1/2" socket spanner set in foam insert

811.0101

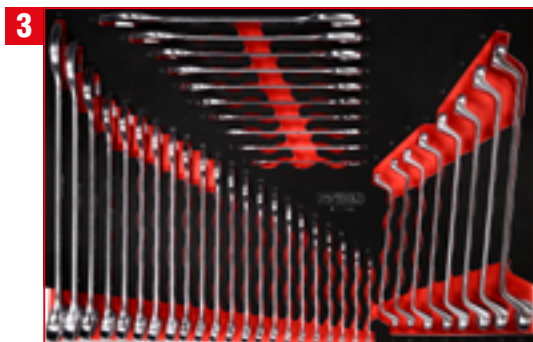

Screw spanner set in foam insert

811.1040



Spanner set in foam insert

811.0012



Hammer, chisel and file set in foam insert

811.0021

M 1/4" socket spanner and screwdriver set

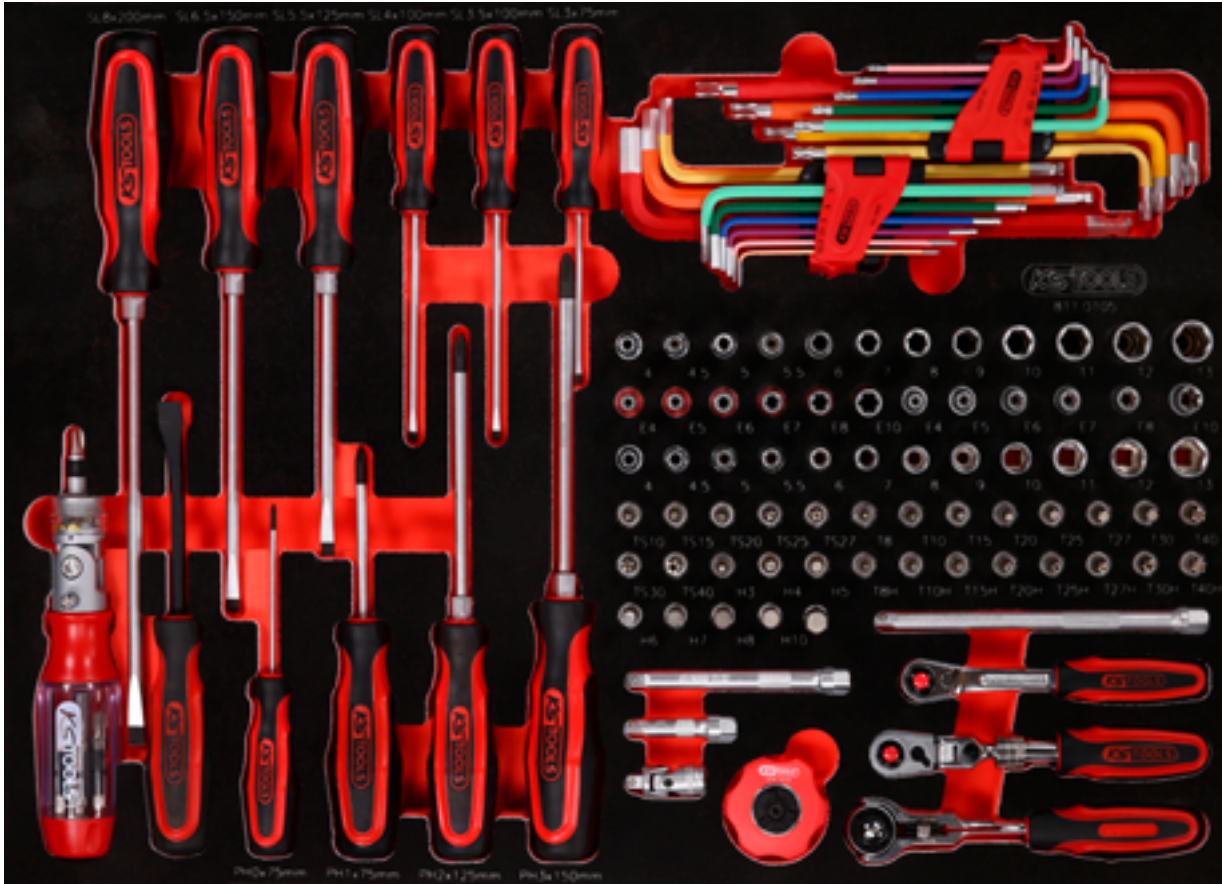

Pos.	Code	Description	pcs	Pos.	Code	Description	pcs	Pos.	Code	Description	pcs
1	159.1011	ERGOTORQUEplus screwdriver for slotted screws, 8 mm, 315 mm long	1	13	151.4420	Ball ended hexagon key wrench set, extra long, 9 pcs	9	30	917.2404	1/4" Torx E Socket, deep, E7	1
2	159.1009	ERGOTORQUEplus screwdriver for slotted screws, 6,5 mm, 255 mm long	1	14	151.4530	Ball ended Torx key wrench set, extra long and bent 108°, 9 pcs	9	31	917.2405	1/4" Torx E Socket, deep, E8	1
3	159.1006	ERGOTORQUEplus screwdriver for slotted screws, 5,5 mm, 230 mm long	1	15	917.1525	1/4" Hexagonal socket, deep, 4 mm	1	32	917.2406	1/4" Torx E Socket, deep, E10	1
4	159.1004	ERGOTORQUEplus screwdriver for slotted screws, 4 mm, 180 mm long	1	16	917.1526	1/4" Hexagonal socket, deep, 4,5 mm	1	33	911.4313	1/4" Torx E Socket, E4	1
5	159.1112	ERGOTORQUEplus screwdriver for slotted screws, 3,5 mm, 180 mm long	1	17	917.1527	1/4" Hexagonal socket, deep, 5 mm	1	34	911.4314	1/4" Torx E Socket, E5	1
6	159.1002	ERGOTORQUEplus screwdriver for slotted screws, 3 mm, 155 mm long	1	18	917.1528	1/4" Hexagonal socket, deep, 5,5 mm	1	35	911.4315	1/4" Torx E Socket, E6	1
7	911.2470	1/4" Ratchet bit screwdriver, 190 mm	1	19	917.1426	1/4" Hexagonal socket, deep, 6 mm	1	36	911.4316	1/4" Torx E Socket, E7	1
8	911.8101	Pry bar, 11x115 mm	1	20	917.1427	1/4" Hexagonal socket, deep, 7 mm	1	37	911.4317	1/4" Torx E Socket, E8	1
9	159.1027	ERGOTORQUEplus screwdriver for screws PH, PH0, 155 mm	1	21	917.1428	1/4" Hexagonal socket, deep, 8 mm	1	38	911.4332	1/4" Torx E Socket, E10	1
10	159.1020	ERGOTORQUEplus screwdriver for screws, PH1, 180 mm	1	22	917.1429	1/4" Hexagonal socket, deep, 9 mm	1	39	917.1404	1/4" Hexagonal socket, 4,5 mm	1
11	159.1022	ERGOTORQUEplus screwdriver for screws PH, PH2, 230 mm	1	23	917.1430	1/4" Hexagonal socket, deep, 10 mm	1	40	917.14045	1/4" Hexagonal socket, 4,5 mm	1
12	159.1024	ERGOTORQUEplus screwdriver for screws PH, PH3, 265 mm	1	24	917.1431	1/4" Hexagonal socket, deep, 11 mm	1	41	917.1405	1/4" Hexagonal socket, 5 mm	1
				25	917.1432	1/4" Hexagonal socket, deep, 12 mm	1	42	917.14055	1/4" Hexagonal socket, 5,5 mm	1
				26	917.1433	1/4" Hexagonal socket, deep, 13 mm	1	43	917.1406	1/4" Hexagonal socket, 6 mm	1
				27	917.2401	1/4" Torx E Socket, deep, E4	1	44	917.1407	1/4" Hexagonal socket, 7 mm	1
				28	917.2402	1/4" Torx E Socket, deep, E5	1	45	917.1408	1/4" Hexagonal socket, 8 mm	1
				29	917.2403	1/4" Torx E Socket, deep, E6	1	46	917.1409	1/4" Hexagonal socket, 9 mm	1
								47	917.1410	1/4" Hexagonal socket, 10 mm	1
								48	917.1411	1/4" Hexagonal socket, 11 mm	1

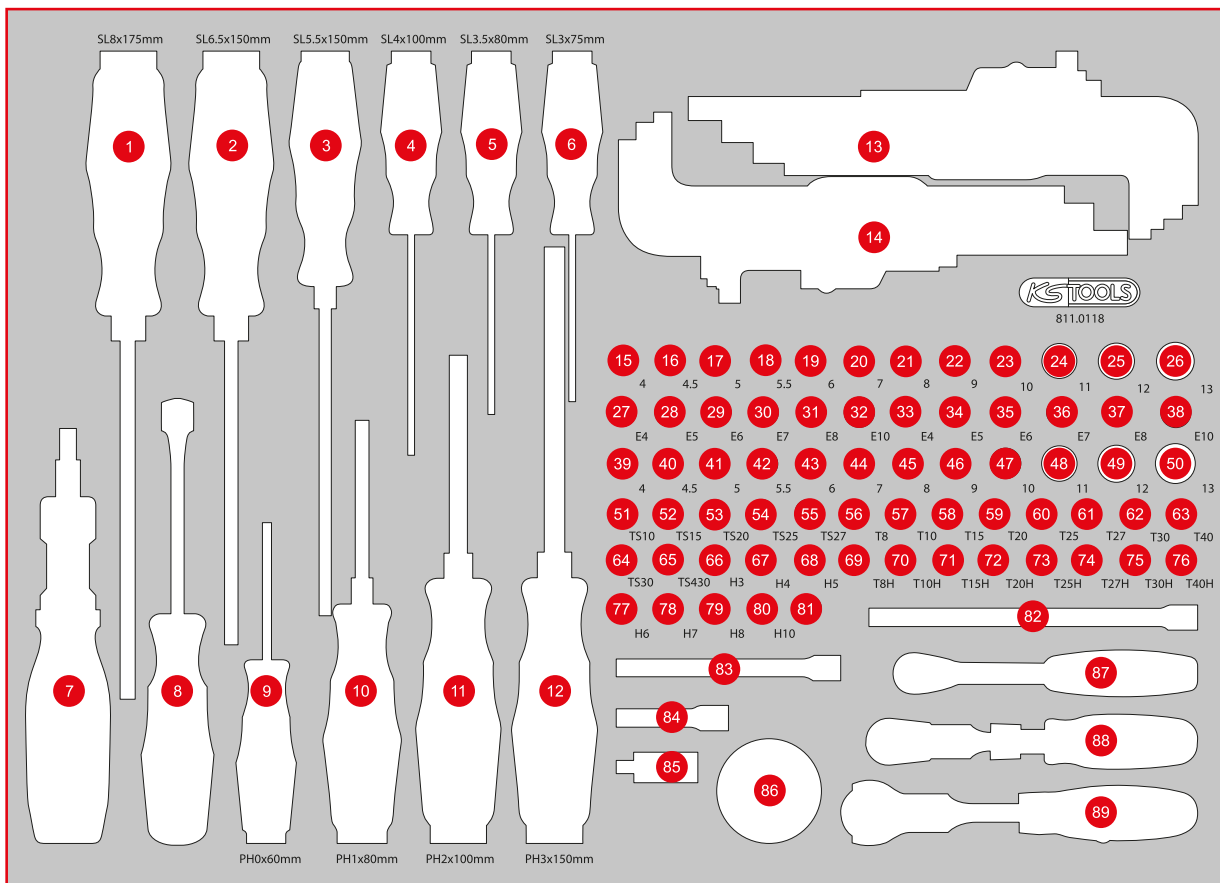

Pos.	Code	Description	pcs	Pos.	Code	Description	pcs	Pos.	Code	Description	pcs
49	917.1412	1/4" Hexagonal socket, 12 mm	1	69	911.1461	1/4" Bit socket Torx tamperproof, TB8	1	87	920.1490	1/4" SlimPOWER Reversible ratchet, 72 teeth	1
50	917.1413	1/4" Hexagonal socket, 13 mm	1	70	911.1462	1/4" Bit socket Torx tamperproof, TB10	1	88	914.1420	1/4" SlimPOWER telescopic-joint reversible ratchet, 72 teeth	1
51	911.1701	1/4" Bit socket five star tamperproof, TS10	1	71	911.1463	1/4" Bit socket Torx tamperproof, TB15	1	89	914.1405	1/4" MODIFIX mini T-handle swivel head ratchet, 72 teeth	1
52	911.1702	1/4" Bit socket five star tamperproof, TS15	1	72	911.1464	1/4" Bit socket Torx tamperproof, TB20	1				
53	911.1703	1/4" Bit socket five star tamperproof, TS20	1	73	911.1465	1/4" Bit socket Torx tamperproof, TB25	1				
54	911.1704	1/4" Bit socket five star tamperproof, TS25	1	74	911.1466	1/4" Bit socket Torx tamperproof, TB27	1				
55	911.1705	1/4" Bit socket five star tamperproof, TS27	1	75	911.1467	1/4" Bit socket Torx tamperproof, TB30	1				
56	911.1448	1/4" Bit socket Torx, T8	1	76	911.1468	1/4" Bit socket Torx tamperproof, TB40	1				
57	911.1442	1/4" Bit socket Torx, T10	1	77	911.1439	1/4" Bit socket hexagon, 6 mm	1				
58	911.1443	1/4" Bit socket Torx, T15	1	78	911.1440	1/4" Bit socket hexagon, 7 mm	1				
59	911.1444	1/4" Bit socket Torx, T20	1	79	911.1441	1/4" Bit socket hexagon, 8 mm	1				
60	911.1445	1/4" Bit socket Torx, T25	1	80	917.1452	1/4" Bit socket hexagon, 10 mm	1				
61	911.1449	1/4" Bit socket Torx, T27	1	81	911.0101	1/4" socket with magnet	1				
62	911.1446	1/4" Bit socket Torx, T30	1	82	911.1451	1/4" Extension with hexagon drive, 150 mm	1				
63	911.1447	1/4" Bit socket Torx, T40	1	83	911.1424	1/4" Extension with hexagon drive, 100 mm	1				
64	911.1706	1/4" Bit socket five star tamperproof, TS30	1	84	911.1423	1/4" Extension with hexagon drive, 50 mm	1				
65	911.1707	1/4" Bit socket five star tamperproof, TS40	1	85	911.1450	1/4" Universal joint	1				
66	911.1436	1/4" Bit socket hexagon, 3 mm	1	86	914.1410	Mini hand reversible ratchet, 1/4", 72 teeth	1				
67	911.1437	1/4" Bit socket hexagon, 4 mm	1								
68	911.1438	1/4" Bit socket hexagon, 5 mm	1								

811.0101

M 3/8" + 1/2" Socket spanner set



Pos.	Code	Description	pcs	Pos.	Code	Description	pcs	Pos.	Code	Description	pcs
1	917.1218	1/2" Hexagonal socket, 18 mm	1	20	917.1212	1/2" Hexagonal socket, 12 mm	1	39	917.3811	3/8" Hexagonal socket, 11 mm	1
2	917.1219	1/2" Hexagonal socket, 19 mm	1	21	917.1211	1/2" Hexagonal socket, 11 mm	1	40	917.3812	3/8" Hexagonal socket, 12 mm	1
3	917.1220	1/2" Hexagonal socket, 20 mm	1	22	917.1210	1/2" Hexagonal socket, 10 mm	1	41	917.3813	3/8" Hexagonal socket, 13 mm	1
4	917.1221	1/2" Hexagonal socket, 21 mm	1	23	917.1341	1/2" Hexagonal socket, 9 mm	1	42	917.3814	3/8" Hexagonal socket, 14 mm	1
5	917.1222	1/2" Hexagonal socket, 22 mm	1	24	917.1340	1/2" Hexagonal socket, 8 mm	1	43	917.3815	3/8" Hexagonal socket, 15 mm	1
6	917.1223	1/2" Hexagonal socket, 23 mm	1	25	911.4333	1/2" Torx E Socket, E10	1	44	917.3816	3/8" Hexagonal socket, 16 mm	1
7	917.1224	1/2" Hexagonal socket, 24 mm	1	26	911.4334	1/2" Torx E Socket, E11	1	45	917.3817	3/8" Hexagonal socket, 17 mm	1
8	917.1342	1/2" Hexagonal socket, 25 mm	1	27	911.4335	1/2" Torx E Socket, E12	1	46	917.3818	3/8" Hexagonal socket, 18 mm	1
9	917.1343	1/2" Hexagonal socket, 26 mm	1	28	911.4336	1/2" Torx E Socket, E14	1	47	917.3819	3/8" Hexagonal socket, 19 mm	1
10	917.1227	1/2" Hexagonal socket, 27 mm	1	29	911.4322	1/2" Torx E Socket, E16	1	48	917.3820	3/8" Hexagonal socket, 20 mm	1
11	917.1344	1/2" Hexagonal socket, 28 mm	1	30	911.4323	1/2" Torx E Socket, E18	1	49	917.3821	3/8" Hexagonal socket, 21 mm	1
12	917.1345	1/2" Hexagonal socket, 29 mm	1	31	911.4324	1/2" Torx E Socket, E20	1	50	917.3822	3/8" Hexagonal socket, 22 mm	1
13	917.1230	1/2" Hexagonal socket, 30 mm	1	32	911.4325	1/2" Torx E Socket, E22	1	51	911.3869	3/8" Bit socket Torx, T15	1
14	917.1232	1/2" Hexagonal socket, 32 mm	1	33	911.4326	1/2" Torx E Socket, E24	1	52	911.3870	3/8" Bit socket Torx, T20	1
15	917.1217	1/2" Hexagonal socket, 17 mm	1	34	917.3806	3/8" Hexagonal socket, 6 mm	1	53	911.3871	3/8" Bit socket Torx, T25	1
16	917.1216	1/2" Hexagonal socket, 16 mm	1	35	917.3807	3/8" Hexagonal socket, 7 mm	1	54	911.3872	3/8" Bit socket Torx, T27	1
17	917.1215	1/2" Hexagonal socket, 15 mm	1	36	917.3808	3/8" Hexagonal socket, 8 mm	1	55	911.3873	3/8" Bit socket Torx, T30	1
18	917.1214	1/2" Hexagonal socket, 14 mm	1	37	917.3809	3/8" Hexagonal socket, 9 mm	1	56	911.3874	3/8" Bit socket Torx, T40	1
19	917.1213	1/2" Hexagonal socket, 13 mm	1	38	917.3810	3/8" Hexagonal socket, 10 mm	1	57	911.3885	3/8" Bit socket Torx, T45	1

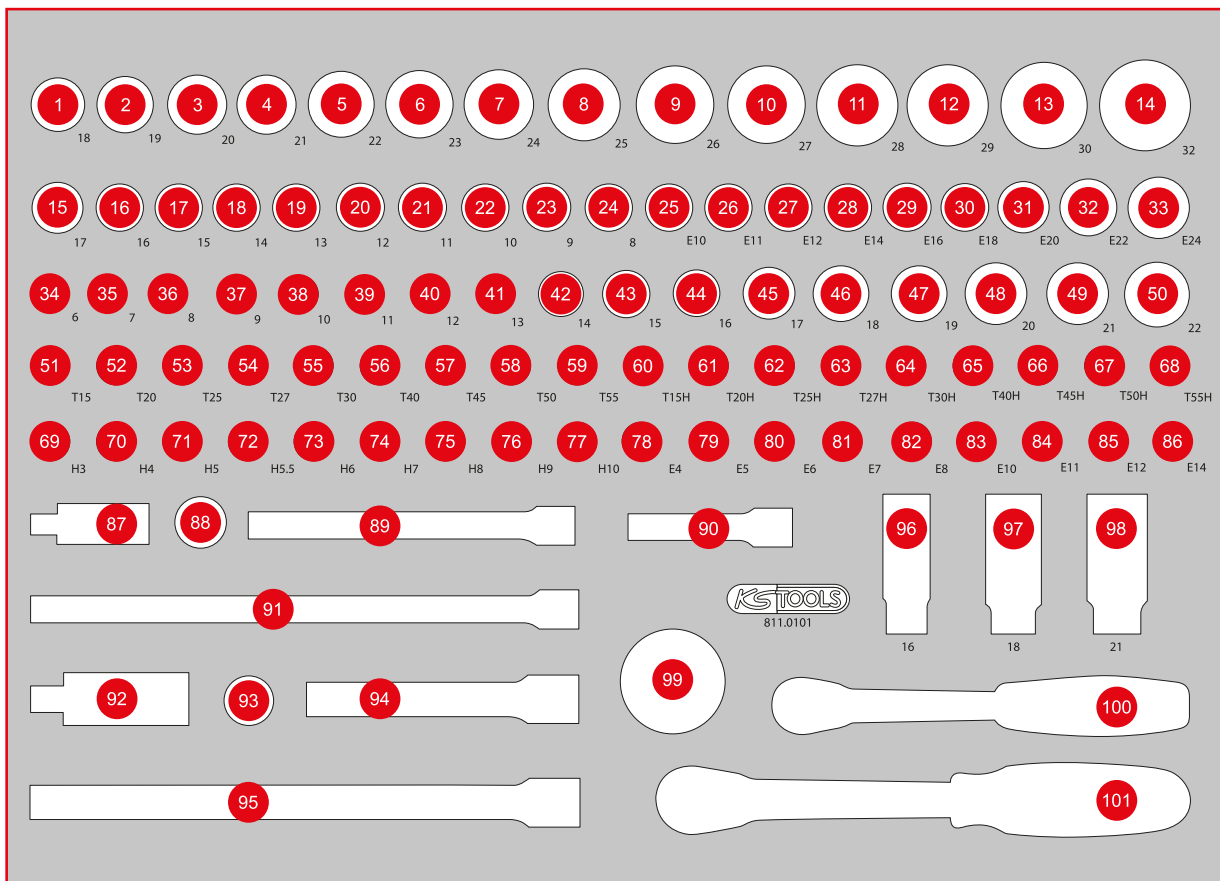

Pos.	Code	Description	pcs	Pos.	Code	Description	pcs	Pos.	Code	Description	pcs
58	911.3884	3/8" Bit socket Torx, T50	1	76	917.3969	3/8" Bit socket hexagon, 9 mm	1	94	911.1202	1/2" Extensions, 125 mm	1
59	911.3888	3/8" Bit socket Torx, T55	1	77	917.3857	3/8" Bit socket hexagon, 10 mm	1	95	911.1203	1/2" Extensions, 250 mm	1
60	911.3961	3/8" Bit socket Torx tamperproof, TB15	1	78	911.4338	3/8" Torx E Socket, E4	1	96	911.3804	3/8" Spark plug socket, 16 mm	1
61	911.3962	3/8" Bit socket Torx tamperproof, TB20	1	79	911.4339	3/8" Torx E Socket, E5	1	97	911.3823	3/8" Spark plug socket, 18 mm	1
62	911.3963	3/8" Bit socket Torx tamperproof, TB25	1	80	911.4340	3/8" Torx E Socket, E6	1	98	911.3805	3/8" Spark plug socket, 21 mm	1
63	911.3964	3/8" Bit socket Torx tamperproof, TB27	1	81	911.4341	3/8" Torx E Socket, E7	1	99	914.3810	Mini hand reversible ratchet, 3/8", 72 teethh	1
64	911.3965	3/8" Bit socket Torx tamperproof, TB30	1	82	911.4342	3/8" Torx E Socket, E8	1	100	920.3890	3/8" SlimPOWER Reversible ratchet, 72 teeth	1
65	911.3966	3/8" Bit socket Torx tamperproof, TB40	1	83	911.4318	3/8" Torx E Socket, E10	1	101	920.1290	1/2" SlimPOWER Reversible ratchet, 72 teeth	1
66	911.3967	3/8" Bit socket Torx tamperproof, TB45	1	84	911.4319	3/8" Torx E Socket, E11	1				
67	911.3968	3/8" Bit socket Torx tamperproof, TB50	1	85	911.4320	3/8" Torx E Socket, E12	1				
68	911.3969	3/8" Bit socket Torx tamperproof, TB55	1	86	911.4321	3/8" Torx E Socket, E14	1				
69	911.3863	3/8" Bit socket hexagon, 3 mm	1	87	911.3850	3/8" Universal joint	1				
70	911.3864	3/8" Bit socket hexagon, 4 mm	1	88	911.3826	3/8" Sliding / reducing adaptor, 1/2" F x 3/8" M	1				
71	911.3865	3/8" Bit socket hexagon, 5 mm	1	89	911.3802	3/8" Extension with knurling, 150 mm	1				
72	911.38655	3/8" Bit socket hexagon, 5,5 mm	1	90	911.3801	3/8" Extension with knurling, 75 mm	1				
73	911.3866	3/8" Bit socket hexagon, 6 mm	1	91	911.3803	3/8" Extension with knurling, 250 mm	1				
74	911.3867	3/8" Bit socket hexagon, 7 mm	1	92	911.1250	1/2" Universal joint	1				
75	911.3868	3/8" Bit socket hexagon, 8 mm	1	93	911.1207	3/8" Sliding adaptor, 3/8" F x 1/2" M	1				

811.1040

M Screw spanner set

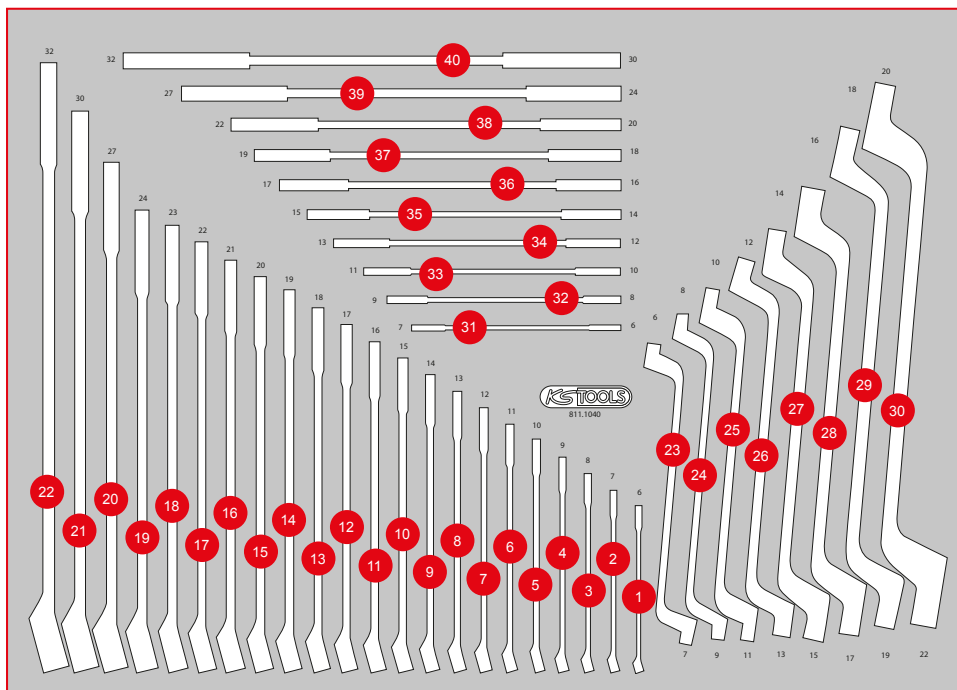
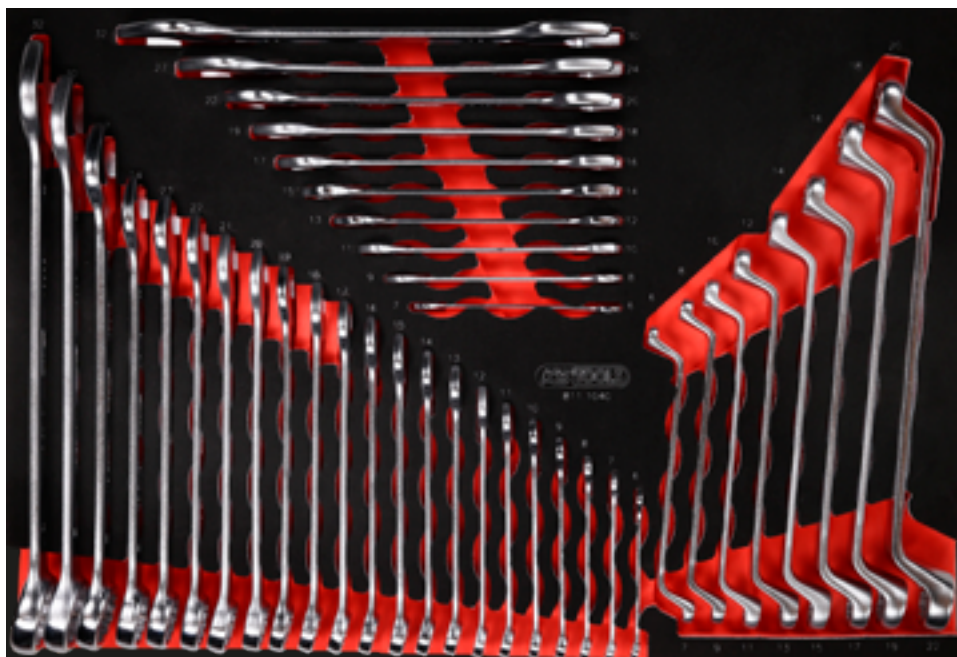

Pos.	Code	Description	pcs
1	517.0606	Combination spanners, offset, 6 mm	1
2	517.0607	Combination spanners, offset, 7 mm	1
3	517.0608	Combination spanners, offset, 8 mm	1
4	517.0609	Combination spanners, offset, 9 mm	1
5	517.0610	Combination spanners, offset, 10 mm	1
6	517.0611	Combination spanners, offset, 11 mm	1
7	517.0612	Combination spanners, offset, 12 mm	1
8	517.0613	Combination spanners, offset, 13 mm	1
9	517.0614	Combination spanners, offset, 14 mm	1
10	517.0615	Combination spanners, offset, 15 mm	1
11	517.0616	Combination spanners, offset, 16 mm	1
12	517.0617	Combination spanners, offset, 17 mm	1
13	517.0618	Combination spanners, offset, 18 mm	1
14	517.0619	Combination spanners, offset, 19 mm	1
15	517.0620	Combination spanners, offset, 20 mm	1
16	517.0621	Combination spanners, offset, 21 mm	1
17	517.0622	Combination spanners, offset, 22 mm	1
18	517.0623	Combination spanners, offset, 23 mm	1
19	517.0624	Combination spanners, offset, 24 mm	1
20	517.0627	Combination spanners, offset, 27 mm	1
21	517.0630	Combination spanners, offset, 30 mm	1
22	517.0632	Combination spanners, offset, 32 mm	1
23	517.0701	Double open ended spanners, 6 x 7 mm	1
24	517.0702	Double open ended spanners, 8 x 9 mm	1
25	517.0704	Double open ended spanners, 10 x 11 mm	1
26	517.0707	Double open ended spanners, 12 x 13 mm	1
27	517.0709	Double open ended spanners, 14 x 15 mm	1
28	517.0710	Double open ended spanners, 16 x 17 mm	1
29	517.0712	Double open ended spanners, 18 x 19 mm	1
30	517.0714	Double open ended spanners, 20 x 22 mm	1
31	517.0716	Double open ended spanners, 24 x 27 mm	1
32	517.0718	Double open ended spanners, 30 x 32 mm	1
33	517.0801	Double ring spanner, offset, 6 x 7 mm	1
34	517.0802	Double ring spanner, offset, 8 x 9 mm	1
35	517.0804	Double ring spanner, offset, 10 x 11 mm	1
36	517.0807	Double ring spanner, offset, 12 x 13 mm	1
37	517.0809	Double ring spanner, offset, 14 x 15 mm	1
38	517.0810	Double ring spanner, offset, 16 x 17 mm	1
39	517.0812	Double ring spanner, offset, 18 x 19 mm	1
40	517.0813	Double ring spanner, offset, 20 x 22 mm	1

811.0012

M Spanner set

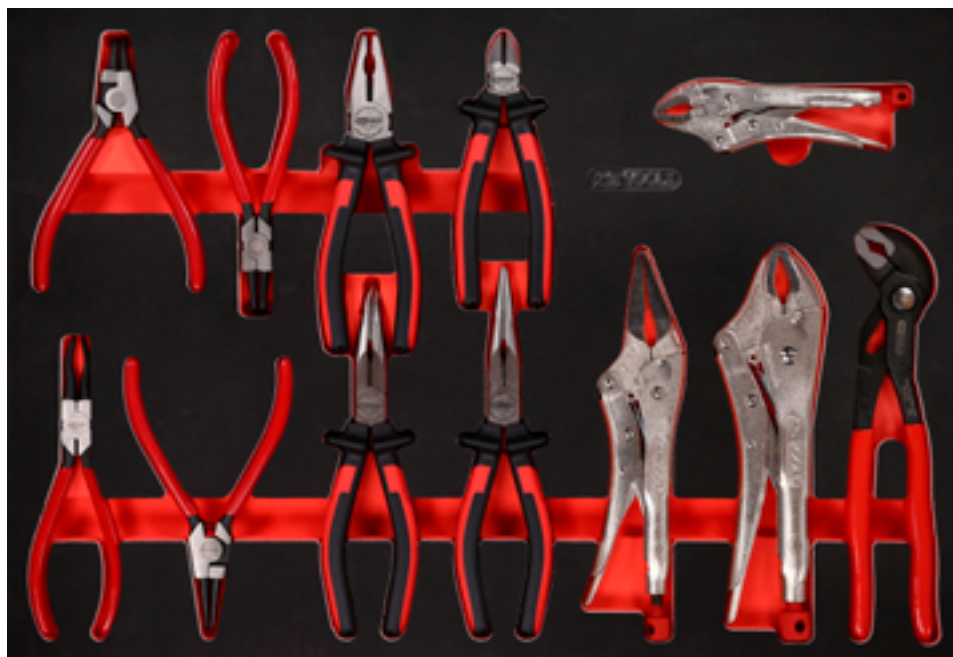

Pos.	Code	Description	pcs
1	115.1021	ERGOTORQUE combination pliers, 180 mm	1
2	115.1012	ERGOTORQUE diagonal side cutter, 160 mm	1
3	115.1019	ERGOTORQUE bent nose pliers serrated, 210 mm	1
4	115.1024	ERGOTORQUE long nose pliers serrated cutter, 200 mm	1
5	500.1026	Circlip pliers for external circlips, angled, 160 mm	1
6	500.1029	Circlip pliers for external circlips, 160 mm	1
7	500.1032	Circlip pliers for internal circlips, angled, 160 mm	1
8	500.1035	Circlip pliers for internal circlips, 160 mm	1
9	115.1031	Locking pliers, 50 mm, 140 mm	1
10	115.1035	Longbacken-Locking pliers, 210 mm	1
11	115.1033	Self grip wrench, 220 mm	1
12	115.2010	Water pump pliers, 240 mm	1

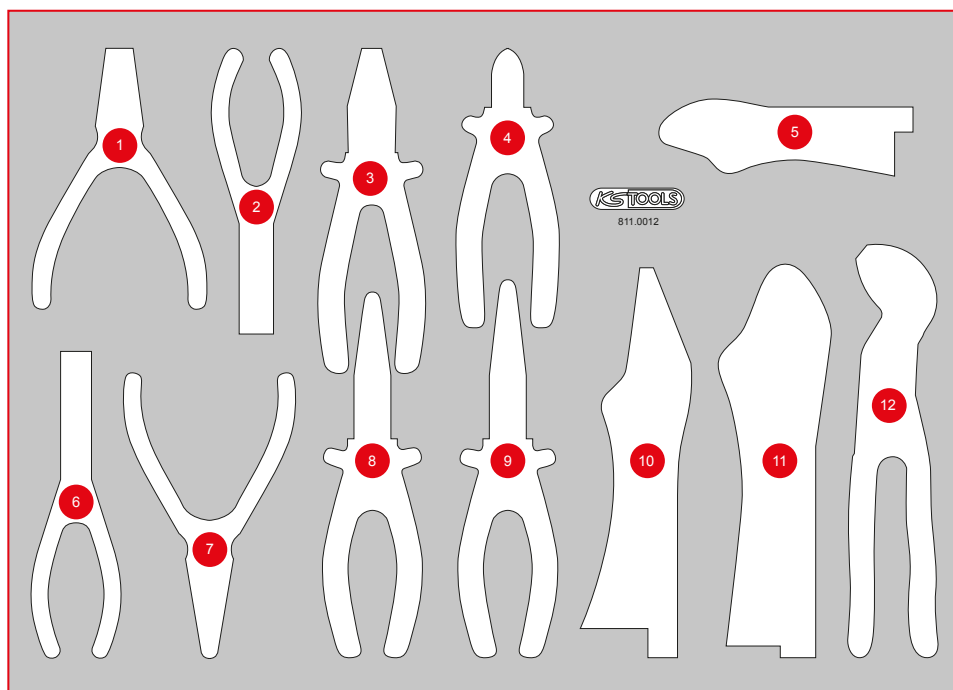

811.0021

M Hammer, chisel and file set



Pos.	Code	Description	pcs
1	140.5252	Recoil free soft faced Hammer, 400 g	1
2	142.1402	Fitters Hammer, fibreglas handle, 400 g	1
3	142.5101	Club Hammer, fibreglas handle, 1000 g	1
4	156.0242	Cross chisel, octagon, 7 mm	1
5	156.0234	Pin punch, Ø 6 mm, cylindrical shaft	1
6	156.0233	Pin punch, Ø 5 mm, cylindrical shaft	1
7	156.0232	Pin punch, cylindrical shaft, 4 mm	1
8	156.0231	Pin punch, cylindrical shaft, 3 mm	1
9	300.0510	Pocket vernier calliper 0-150 mm, 235 mm	1
10	157.0405	Tri-bastard file, form C, cut 2, 200 mm	1
11	157.0960	Brake saddle file, extra narrow, 270 mm	1
12	157.0205	Round file, form F, cut 2, 200 mm	1
13	156.0243	Centre punch, octagon 10 mm	1
14	156.0238	Punch, Ø 4 mm, conical	1
15	156.0237	Punch, Ø 3 mm, conical	1
16	156.0252	Flat chisel, octagon, 12 mm	1
17	156.0253	Flat chisel, octagon, 16 mm	1
18	156.0254	Flat chisel, octagon, 18 mm	1
19	156.0241	Flat chisel, octagon, 20 mm	1
20	201.2335	Steel wire brake saddle brush, 2-row, straight	1
21	300.0104	Flexible steel rule, 300 mm	1

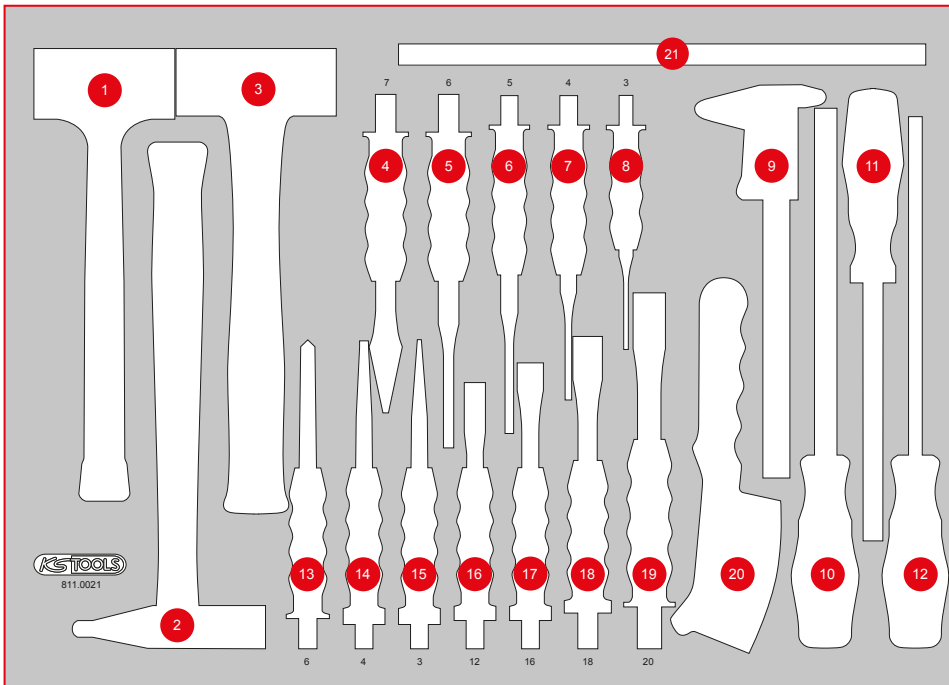

P35

873.5008-R014P

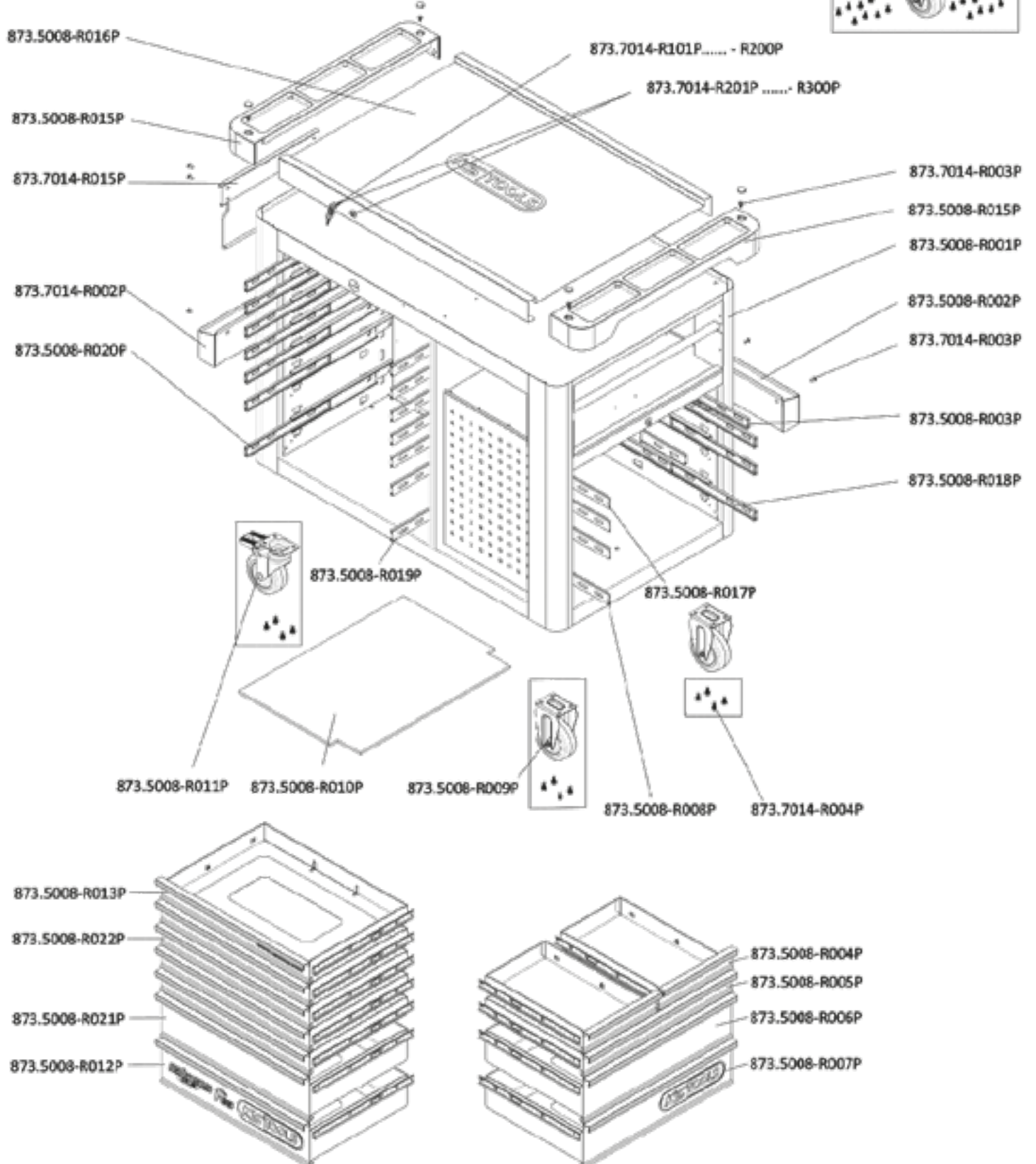



INDIVIDUAL PARTS LIST

Art.-Nr.	Description	amount
873.7014-R101P...	Replacement key for PERFORMANCEplus workshop trolley lock number xyz	2
873.7014-R201P...	Lock with 2 keys for PERFORMANCEplus workshop trolley lock number xyz	2
873.5008-R001P	Body with handle	1
873.5008-R002P	Can holder for PERFORMANCEplus workshop trolley P10/P15/P25/P35	1
873.5008-R003P	Full extension (with ball-bearing guide) with automatic retraction	2
873.5008-R004P	Compartment with ball-bearing guide, 268x398x65 mm	2
873.5008-R005P	Compartment with ball-bearing guide, 568x398x65 mm	1
873.5008-R006P	Compartment with ball-bearing guide, 568x398x145 mm	1
873.5008-R007P	Compartment with logo and ball-bearing guide, 568x398x145 mm	1
873.5008-R008P	Full extension (with ball-bearing guide) with automatic retraction	3
873.5008-R009P	Fixed castors for PERFORMANCEplus workshop trolley, incl. screws	2
873.5008-R010P	Foam support	1
873.5008-R011P	Swivel castors with brakes, for PERFORMANCEplus workshop trolley, incl. screws	2
873.5008-R012P	Compartment with logo and ball-bearing guide, 568x398x145 mm	1
873.5008-R013P	Compartment with website and ball-bearing guide, 568x398x65 mm	1
873.5008-R014P	Roller set for PERFORMANCEplus workshop trolley, incl. screws	1
873.5008-R015P	Storage for work surface	2
873.5008-R016P	Stainless steel work surface	1
873.5008-R017P	Full extension (with ball-bearing guide) with automatic retraction	2
873.5008-R018P	Full extension (with ball-bearing guide) with automatic retraction	3
873.5008-R019P	Full extension (with ball-bearing guide) with automatic retraction	7
873.5008-R020P	Full extension (with ball-bearing guide) with automatic retraction	7
873.5008-R021P	Compartment with ball-bearing guide, 568x398x145 mm	1
873.5008-R022P	Compartment with ball-bearing guide, 568x398x65 mm	4
873.7014-R002P	Can holder for PERFORMANCEplus workshop trolley P20/P30/P35/P40/P45	1
873.7014-R003P	M6x12 screw (1 pcs.) for PERFORMANCEplus workshop trolley accessories	12
873.7014-R004P	M8 screws for PERFORMANCEplus workshop trolley rollers (16 pcs.)	1
873.7014-R015P	Paper roll holder for PERFORMANCEplus workshop trolley P20/P30/P35/P40/P45	1

P35



873.7014-R101P...R200P
Replacement key for lock number xyz



873.7014-R201P...R300P
Lock with 2 keys, lock number xyz



873.5008-R003P
Full extension (with ball-bearing guide) with automatic retraction, right



873.5008-R008P
Full extension with self-closing for drawer, left



873.5008-R019P
Full extension with self-closing for drawer, right



873.5008-R020P
Full extension with self-closing for drawer, left



873.5008-R018P
Full extension with self-closing for drawer, right



873.5008-R017P
Full extension with self-closing for drawer, left

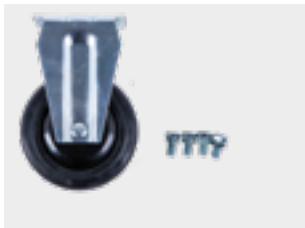

873.5008-R009P
Fixed castors, incl. screws



873.5008-R011P
Swivel castors with brakes, incl. screws



873.5008-R014P
Roller set, incl. screws

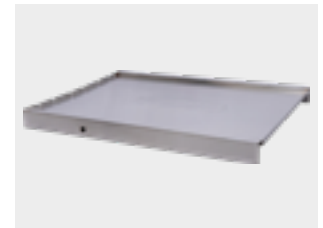

873.5008-R016P
Stainless steel work surface



873.5008-R010P
Foam support, 8 mm



873.5008-R015P
Storage for work surface, including screw cover, usable on both sides



873.5008-R013P
Compartment with website and ball-bearing guide, 568x398x65 mm



873.5008-R005P
Compartment with ball-bearing guide, 568x398x65 mm



873.5008-R006P
Compartment with ball-bearing guide, 568x398x145 mm



873.5008-R012P
Compartment with logo and ball-bearing guide, 568x398x145 mm



873.5008-R004P
Compartment with ball-bearing guide, 268x398x65 mm



873.5008-R022P
Compartment with ball-bearing guide, 568x398x65 mm



873.5008-R021P
Compartment with ball-bearing guide, 568x398x145 mm



873.5008-R007P
Compartment with logo and ball-bearing guide, 568x398x145 mm



873.5008-R002P
Can holder including screws, W = 310 mm



873.7014-R002P
Can holder including screws, W = 445 mm



873.7014-R015P
Paper roll holder including screws, W= 400 mm

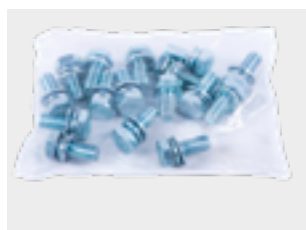

873.7014-R004P
M8 screws (16 pcs.)



873.7014-R003P
M6x12 screw (1 pcs.)



873.5008-R001P
Body of workshop trolley attachment