

P25

workshop tool trolley
with 416 tools for 6 drawers
825.6416

PRECIOUS WIDTH



Workshop trolley P25
with 8 compartments
873.3008

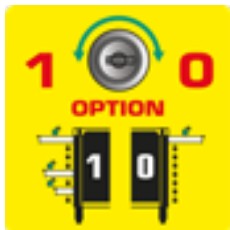

DUO Lock Brilliant locking system



8 Drawers each load capacity up to 50 kg



Stable **ball bearing**



Stainless steel surface



Lock lockable



Anti-static castors with brakes



Integrated **corner protection**



Paper roll holder included



Can holder included

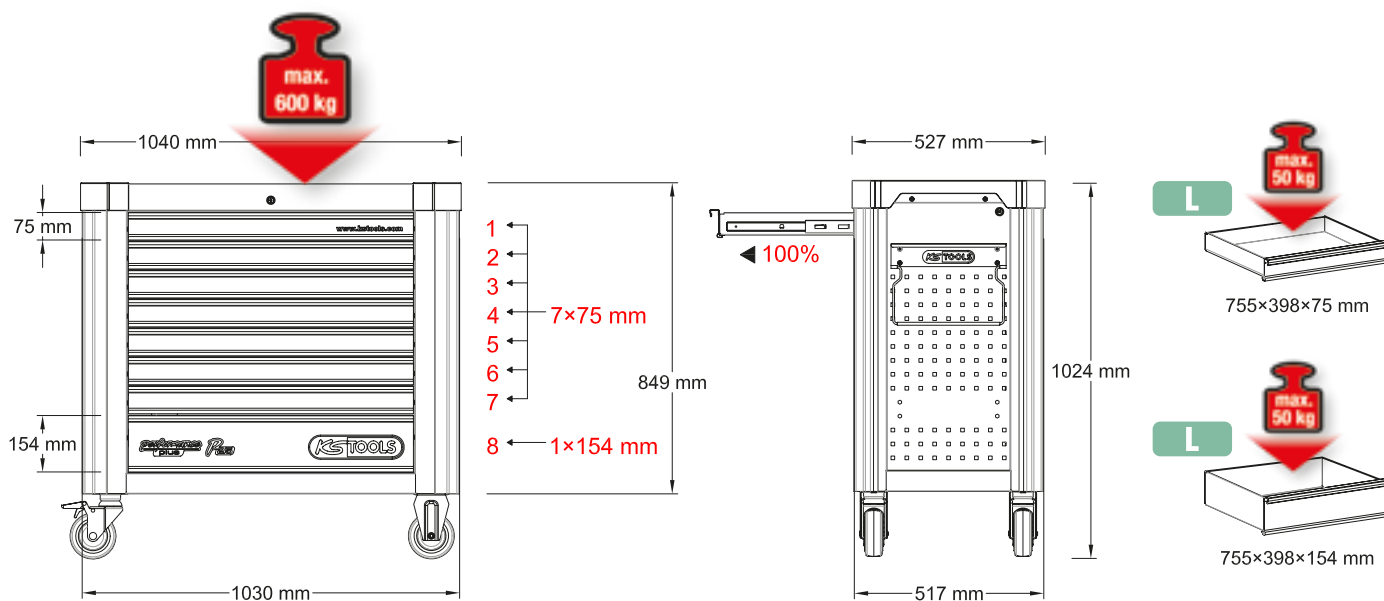

P25 workshop tool trolley set with 416 tools for 6 drawers

825.6416



1 Screwdriver set in foam insert

813.1033

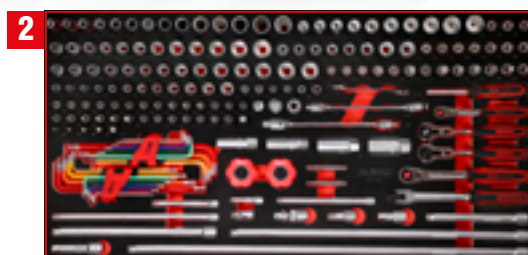

2 1/4" + 3/8" socket spanner set in foam insert

813.0183



3 1/2" socket spanner set in foam insert

813.0085

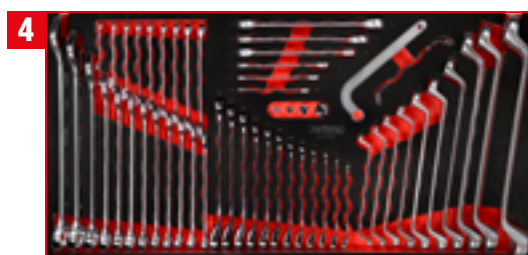

4 Screw spanner set in foam insert

813.0055



5 T-handle angle wrench and screwdriver set in foam insert

813.0024



6 Hammer, chisel and measuring tool set in foam insert

813.1036

813.1033

L Screwdriver set

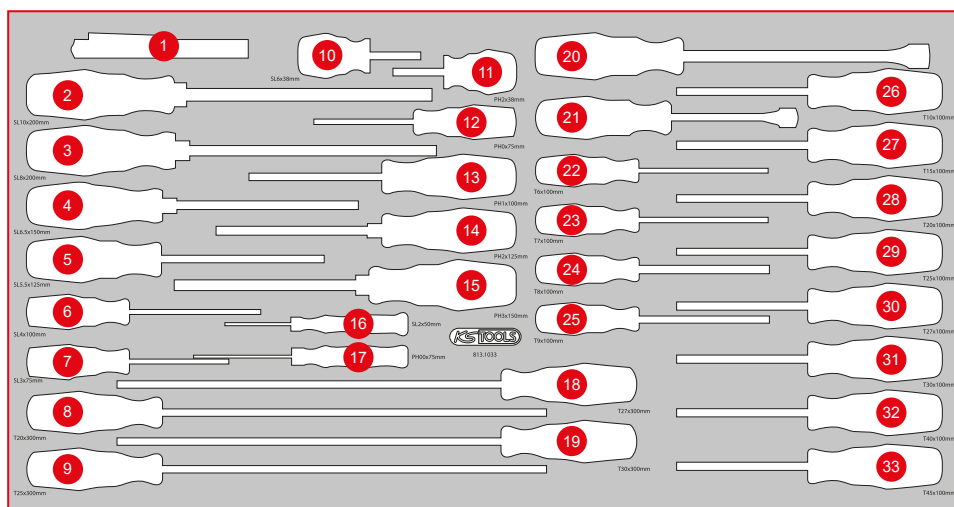

| Pos. | Code | Description | pcs |
|------|----------|--|-----|
| 1 | 150.4370 | perfectLight torch 85 lumen | 1 |
| 2 | 159.1012 | ERGOTORQUEplus screwdriver for slotted screws, 10 mm, 315 mm long | 1 |
| 3 | 159.1011 | ERGOTORQUEplus screwdriver for slotted screws, 8 mm, 315 mm long | 1 |
| 4 | 159.1009 | ERGOTORQUEplus screwdriver for slotted screws, 6,5 mm, 255 mm long | 1 |
| 5 | 159.1006 | ERGOTORQUEplus screwdriver for slotted screws, 5,5 mm, 230 mm long | 1 |
| 6 | 159.1004 | ERGOTORQUEplus screwdriver for slotted screws, 4 mm, 180 mm long | 1 |
| 7 | 159.1002 | ERGOTORQUEplus screwdriver for slotted screws, 3 mm, 155 mm long | 1 |
| 8 | 159.1261 | ERGOTORQUEplus screwdriver, Torx, T20, long | 1 |
| 9 | 159.1262 | ERGOTORQUEplus screwdriver, Torx, T25, long | 1 |
| 10 | 159.1001 | ERGOTORQUEplus screwdriver for slotted screws, short, 6 mm | 1 |
| 11 | 159.1026 | ERGOTORQUEplus screwdriver, Torx, short, PH2 | 1 |
| 12 | 159.1027 | ERGOTORQUEplus screwdriver, Torx, PH0, 155 mm | 1 |
| 13 | 159.1029 | ERGOTORQUEplus screwdriver, Torx, PH1, 205 mm | 1 |
| 14 | 159.1022 | ERGOTORQUEplus screwdriver, Torx, PH2, 230 mm | 1 |
| 15 | 159.1024 | ERGOTORQUEplus screwdriver, Torx, PH3, 265 mm | 1 |
| 16 | 500.7109 | Precision screwdriver, slot, 2 mm | 1 |
| 17 | 500.7831 | Precision screwdriver, PHILLIPS, PH00 x 2,0 mm | 1 |
| 18 | 159.1263 | ERGOTORQUEplus screwdriver, Torx, T27, long | 1 |
| 19 | 159.1264 | ERGOTORQUEplus screwdriver, Torx, T30, long | 1 |
| 20 | 911.8102 | Pry bar, 15 x 185 mm | 1 |
| 21 | 911.8101 | Pry bar, 11 x 115 mm | 1 |
| 22 | 159.1134 | ERGOTORQUEplus screwdriver, Torx, T6 | 1 |
| 23 | 159.1135 | ERGOTORQUEplus screwdriver, Torx, T7 | 1 |
| 24 | 159.1030 | ERGOTORQUEplus screwdriver, Torx, T8 | 1 |
| 25 | 159.1031 | ERGOTORQUEplus screwdriver, Torx, T9 | 1 |
| 26 | 159.1032 | ERGOTORQUEplus screwdriver, Torx, T10 | 1 |
| 27 | 159.1033 | ERGOTORQUEplus screwdriver, Torx, T15 | 1 |
| 28 | 159.1034 | ERGOTORQUEplus screwdriver, Torx, T20 | 1 |
| 29 | 159.1035 | ERGOTORQUEplus screwdriver, Torx, T25 | 1 |
| 30 | 159.1036 | ERGOTORQUEplus screwdriver, Torx, T27 | 1 |
| 31 | 159.1037 | ERGOTORQUEplus screwdriver, Torx, T30 | 1 |
| 32 | 159.1038 | ERGOTORQUEplus screwdriver, Torx, T40 | 1 |
| 33 | 159.1136 | ERGOTORQUEplus screwdriver, Torx, T45 | 1 |

813.0183

L 1/4" + 3/8" Socket spanner set

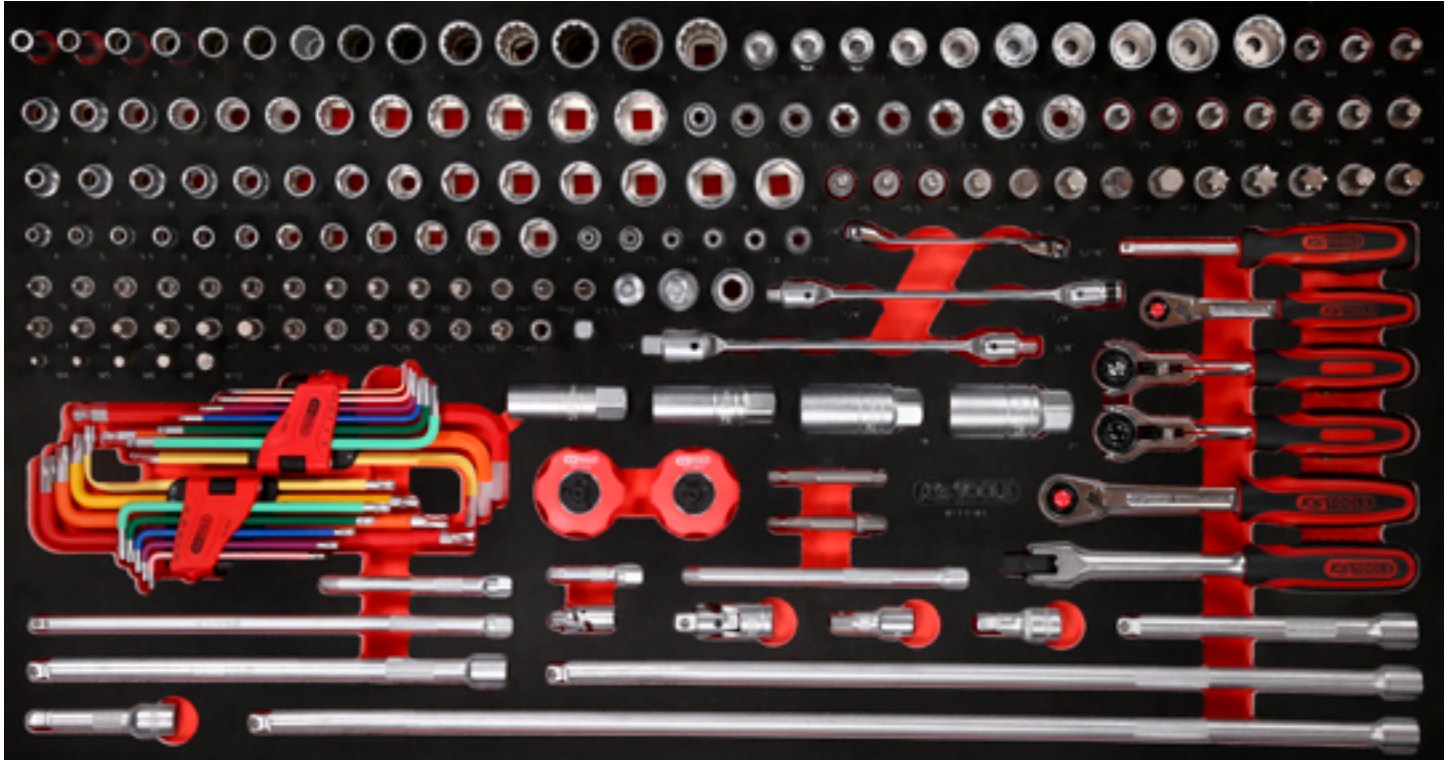

| Pos. | Code | Description | pcs | Pos. | Code | Description | pcs | Pos. | Code | Description | pcs |
|------|----------|---------------------------------------|-----|------|----------|----------------------------------|-----|------|-----------|-----------------------------------|-----|
| 1 | 917.4831 | 3/8" 12 Point socket, deep, 6 mm | 1 | 31 | 911.3984 | 3/8" 12 Point socket, 11 mm | 1 | 61 | 917.3812 | 3/8" Hexagonal socket, 12 mm | 1 |
| 2 | 917.4832 | 3/8" 12 Point socket, deep, 7 mm | 1 | 32 | 911.3985 | 3/8" 12 Point socket, 12 mm | 1 | 62 | 917.3813 | 3/8" Hexagonal socket, 13 mm | 1 |
| 3 | 917.3855 | 3/8" 12 Point socket, deep, 8 mm | 1 | 33 | 911.3986 | 3/8" 12 Point socket, 13 mm | 1 | 63 | 917.3814 | 3/8" Hexagonal socket, 14 mm | 1 |
| 4 | 917.3856 | 3/8" 12 Point socket, deep, 9 mm | 1 | 34 | 911.3987 | 3/8" 12 Point socket, 14 mm | 1 | 64 | 917.3815 | 3/8" Hexagonal socket, 15 mm | 1 |
| 5 | 917.3970 | 3/8" 12 Point socket, deep, 10 mm | 1 | 35 | 911.3988 | 3/8" 12 Point socket, 15 mm | 1 | 65 | 917.3816 | 3/8" Hexagonal socket, 16 mm | 1 |
| 6 | 917.3971 | 3/8" 12 Point socket, deep, 11 mm | 1 | 36 | 911.3989 | 3/8" 12 Point socket, 16 mm | 1 | 66 | 917.3817 | 3/8" Hexagonal socket, 17 mm | 1 |
| 7 | 917.3972 | 3/8" 12 Point socket, deep, 12 mm | 1 | 37 | 911.3992 | 3/8" 12 Point socket, 17 mm | 1 | 67 | 917.3818 | 3/8" Hexagonal socket, 18 mm | 1 |
| 8 | 917.3973 | 3/8" 12 Point socket, deep, 13 mm | 1 | 38 | 911.3994 | 3/8" 12 Point socket, 19 mm | 1 | 68 | 917.3819 | 3/8" Hexagonal socket, 19 mm | 1 |
| 9 | 917.3974 | 3/8" 12 Point socket, deep, 14 mm | 1 | 39 | 911.3996 | 3/8" 12 Point socket, 21 mm | 1 | 69 | 911.3865 | 3/8" Bit socket hexagon, 5 mm | 1 |
| 10 | 917.3975 | 3/8" 12 Point socket, deep, 15 mm | 1 | 40 | 911.4342 | 3/8" Torx E Socket, E8 | 1 | 70 | 911.38655 | 3/8" Bit socket hexagon, 5,5 mm | 1 |
| 11 | 917.3976 | 3/8" 12 Point socket, deep, 16 mm | 1 | 41 | 911.4318 | 3/8" Torx E Socket, E10 | 1 | 71 | 911.3866 | 3/8" Bit socket hexagon, 6 mm | 1 |
| 12 | 917.3977 | 3/8" 12 Point socket, deep, 17 mm | 1 | 42 | 911.4319 | 3/8" Torx E Socket, E11 | 1 | 72 | 911.3867 | 3/8" Bit socket hexagon, 7 mm | 1 |
| 13 | 917.3978 | 3/8" 12 Point socket, deep, 18 mm | 1 | 43 | 911.4320 | 3/8" Torx E Socket, E12 | 1 | 73 | 911.3868 | 3/8" Bit socket hexagon, 8 mm | 1 |
| 14 | 917.3979 | 3/8" 12 Point socket, deep, 19 mm | 1 | 44 | 911.4321 | 3/8" Torx E Socket, E14 | 1 | 74 | 917.3969 | 3/8" Bit socket hexagon, 9 mm | 1 |
| 15 | 917.4851 | 3/8" 12-edge socket with joint, 10 mm | 1 | 45 | 911.4343 | 3/8" Torx E Socket, E16 | 1 | 75 | 917.3857 | 3/8" Bit socket hexagon, 10 mm | 1 |
| 16 | 917.4852 | 3/8" 12-edge socket with joint, 11 mm | 1 | 46 | 911.4344 | 3/8" Torx E Socket, E18 | 1 | 76 | 911.3862 | 3/8" Bit socket hexagon, 12 mm | 1 |
| 17 | 917.4853 | 3/8" 12-edge socket with joint, 12 mm | 1 | 47 | 911.4345 | 3/8" Torx E Socket, E20 | 1 | 77 | 911.3884 | 3/8" Bit socket Torx, T50 | 1 |
| 18 | 917.4854 | 3/8" 12-edge socket with joint, 13 mm | 1 | 48 | 911.3871 | 3/8" Bit socket Torx, T25 | 1 | 78 | 911.3888 | 3/8" Bit socket Torx, T55 | 1 |
| 19 | 917.4855 | 3/8" 12-edge socket with joint, 14 mm | 1 | 49 | 911.3872 | 3/8" Bit socket Torx, T27 | 1 | 79 | 911.3889 | 3/8" Bit socket Torx, T60 | 1 |
| 20 | 917.4856 | 3/8" 12-edge socket with joint, 15 mm | 1 | 50 | 911.3873 | 3/8" Bit socket Torx, T30 | 1 | 80 | 911.3920 | 3/8" Bit socket spline (XZN), M10 | 1 |
| 21 | 917.4857 | 3/8" 12-edge socket with joint, 16 mm | 1 | 51 | 911.3874 | 3/8" Bit socket Torx, T40 | 1 | 81 | 917.3903 | 3/8" Bit socket spline (XZN), M12 | 1 |
| 22 | 917.4858 | 3/8" 12-edge socket with joint, 17 mm | 1 | 52 | 911.3885 | 3/8" Bit socket Torx, T45 | 1 | 82 | 917.1404 | 1/4" Hexagonal socket, 4 mm | 1 |
| 23 | 917.4859 | 3/8" 12-edge socket with joint, 18 mm | 1 | 53 | 911.3917 | 3/8" Bit socket spline (XZN), M8 | 1 | 83 | 917.1405 | 1/4" Hexagonal socket, 5 mm | 1 |
| 24 | 917.4861 | 3/8" 12-edge socket with joint, 19 mm | 1 | 54 | 917.3901 | 3/8" Bit socket spline (XZN), M9 | 1 | 84 | 917.14055 | 1/4" Hexagonal socket, 5,5 mm | 1 |
| 25 | 911.3918 | 3/8" Bit socket spline (XZN), M4 | 1 | 55 | 917.3806 | 3/8" Hexagonal socket, 6 mm | 1 | 85 | 917.1406 | 1/4" Hexagonal socket, 6 mm | 1 |
| 26 | 911.3915 | 3/8" Bit socket spline (XZN), M5 | 1 | 56 | 917.3807 | 3/8" Hexagonal socket, 7 mm | 1 | 86 | 917.1407 | 1/4" Hexagonal socket, 7 mm | 1 |
| 27 | 911.3916 | 3/8" Bit socket spline (XZN), M6 | 1 | 57 | 917.3808 | 3/8" Hexagonal socket, 8 mm | 1 | 87 | 917.1408 | 1/4" Hexagonal socket, 8 mm | 1 |
| 28 | 911.3981 | 3/8" 12 Point socket, 8 mm | 1 | 58 | 917.3809 | 3/8" Hexagonal socket, 9 mm | 1 | 88 | 917.1409 | 1/4" Hexagonal socket, 9 mm | 1 |
| 29 | 911.3982 | 3/8" 12 Point socket, 9 mm | 1 | 59 | 917.3810 | 3/8" Hexagonal socket, 10 mm | 1 | 89 | 917.1410 | 1/4" Hexagonal socket, 10 mm | 1 |
| 30 | 911.3983 | 3/8" 12 Point socket, 10 mm | 1 | 60 | 917.3811 | 3/8" Hexagonal socket, 11 mm | 1 | 90 | 917.1411 | 1/4" Hexagonal socket, 11 mm | 1 |

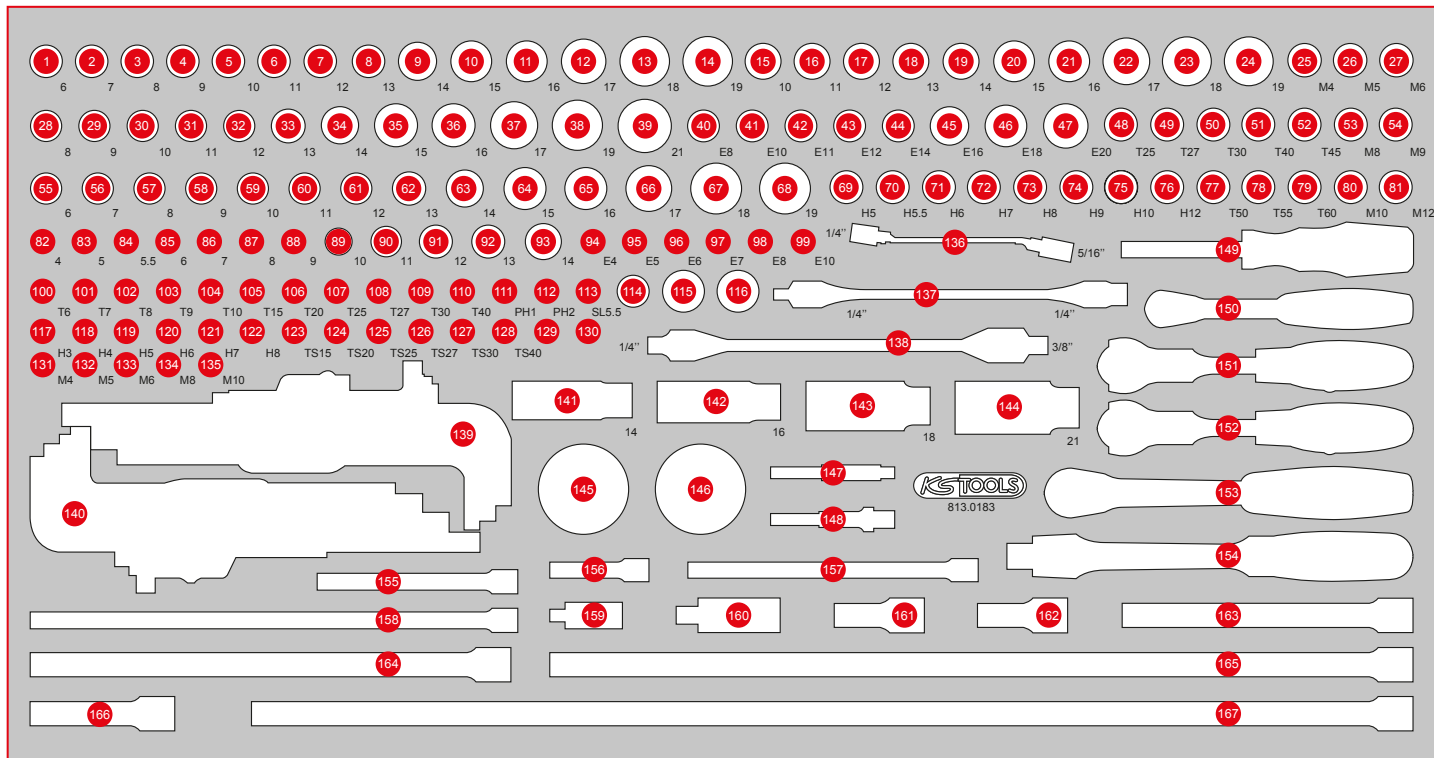

| Pos. | Code | Description | pcs | Pos. | Code | Description | pcs | Pos. | Code | Description | pcs |
|------|----------|--|-----|------|----------|---|-----|------|----------|--|-----|
| 91 | 917.1412 | 1/4" Hexagonal socket, 12 mm | 1 | 121 | 911.1440 | 1/4" Bit socket hexagon, 7 mm | 1 | 148 | 514.1107 | Socket adaptor, 1/4"x3/8" | 1 |
| 92 | 917.1413 | 1/4" Hexagonal socket, 13 mm | 1 | 122 | 911.1441 | 1/4" Bit socket hexagon, 8 mm | 1 | 149 | 911.1434 | 1/4" Square drive screwdriver, 150 mm | 1 |
| 93 | 917.1414 | 1/4" Hexagonal socket, 14 mm | 1 | 123 | 911.1702 | 1/4" Bit socket five star tamperproof, TS15 | 1 | 150 | 920.1490 | 1/4" SlimPOWER Reversible ratchet, 72 teeth | 1 |
| 94 | 911.4313 | 1/4" Torx E Socket, E4 | 1 | 124 | 911.1703 | 1/4" Bit socket five star tamperproof, TS20 | 1 | 151 | 914.1405 | 1/4" MODIFIX mini T-handle swivel head ratchet, 72 teeth | 1 |
| 95 | 911.4314 | 1/4" Torx E Socket, E5 | 1 | 125 | 911.1704 | 1/4" Bit socket five star tamperproof, TS25 | 1 | 152 | 914.3815 | 3/8" MODIFIX mini T-handle swivel head ratchet, 72 teeth, 0°+90° | 1 |
| 96 | 911.4315 | 1/4" Torx E Socket, E6 | 1 | 126 | 911.1705 | 1/4" Bit socket five star tamperproof, TS27 | 1 | 153 | 920.3890 | 3/8" SlimPOWER Reversible ratchet, 72 teeth | 1 |
| 97 | 911.4316 | 1/4" Torx E Socket, E7 | 1 | 127 | 911.1706 | 1/4" Bit socket five star tamperproof, TS30 | 1 | 154 | 917.3939 | 3/8" Flexi head drive handle | 1 |
| 98 | 911.4317 | 1/4" Torx E Socket, E8 | 1 | 128 | 911.1707 | 1/4" Bit socket five star tamperproof, TS40 | 1 | 155 | 911.1424 | 1/4" Extension with hexagon drive, 100 mm | 1 |
| 99 | 911.4332 | 1/4" Torx E Socket, E10 | 1 | 129 | 911.0101 | 1/4" socket with magnet | 1 | 156 | 911.1423 | 1/4" Extension with hexagon drive, 50 mm | 1 |
| 100 | 911.4407 | 1/4" Bit socket Torx, T6 | 1 | 130 | 911.1494 | Adaptor, 1/4" Mx3/8" F | 1 | 157 | 911.1451 | 1/4" Extension with hexagon drive, 150 mm | 1 |
| 101 | 911.4362 | 1/4" Bit socket Torx, T7 | 1 | 131 | 911.2341 | 1/4" Bit spline XZN, 25 mm, M4 | 1 | 158 | 911.1543 | 1/4" Wobble extension with hexagon drive, 250 mm | 1 |
| 102 | 911.1448 | 1/4" Bit socket Torx, T8 | 1 | 132 | 911.2344 | 1/4" Bit spline XZN, 25 mm, M5 | 1 | 159 | 911.1450 | 1/4" Universal joint | 1 |
| 103 | 911.1478 | 1/4" Bit socket Torx, T9 | 1 | 133 | 911.2347 | 1/4" Bit spline XZN, 25 mm, M6 | 1 | 160 | 911.3850 | 3/8" Universal joint | 1 |
| 104 | 911.1442 | 1/4" Bit socket Torx, T10 | 1 | 134 | 911.2350 | 1/4" Bit spline XZN, 25 mm, M8 | 1 | 161 | 911.3852 | 3/8" Extension with knurling, 45 mm | 1 |
| 105 | 911.1443 | 1/4" Bit socket Torx, T15 | 1 | 135 | 911.2353 | 1/4" Bit spline XZN, 25 mm, M10 | 1 | 162 | 911.3910 | Wobble extension, 3/8", 45 mm | 1 |
| 106 | 911.1444 | 1/4" Bit socket Torx, T20 | 1 | 136 | 503.4679 | GEARplus mini reversible ratcheting spanner, 1/4"x5/16" | 1 | 163 | 911.3912 | Wobble extension, 3/8", 150 mm | 1 |
| 107 | 911.1445 | 1/4" Bit socket Torx, T25 | 1 | 137 | 517.0314 | Double-joint spanner 1/4" Bits and sockets | 1 | 164 | 911.3914 | Wobble extension, 3/8", 250 mm | 1 |
| 108 | 911.1449 | 1/4" Bit socket Torx, T27 | 1 | 138 | 517.0338 | Double-joint-spanner for 1/4" and 3/8" sockets | 1 | 165 | 911.0045 | Wobble extension, 3/8", 450 mm | 1 |
| 109 | 911.1446 | 1/4" Bit socket Torx, T30 | 1 | 139 | 151.4530 | Ball ended Torx key wrench set, extra long and bent 108°, 9 pcs | 9 | 166 | 911.3911 | Wobble extension, 3/8", 75 mm | 1 |
| 110 | 911.1447 | 1/4" Bit socket Torx, T40 | 1 | 140 | 151.4420 | Ball ended hexagon key wrench set, extra long, 9 pcs | 9 | 167 | 911.4892 | 3/8" Extensions 600 mm | 1 |
| 111 | 911.1415 | 1/4" Bit socket, PH1 | 1 | 141 | 911.3990 | 3/8" Special spark plug socket, thin-walled 14 mm | 1 | | | | |
| 112 | 911.1416 | 1/4" Bit socket, PH2 | 1 | 142 | 911.3804 | 3/8" Spark plug socket, 16 mm | 1 | | | | |
| 113 | 911.1419 | 1/4" Bit socket slot, 5,5 mm | 1 | 143 | 911.3823 | 3/8" Spark plug socket, 18 mm | 1 | | | | |
| 114 | 911.3897 | 3/8" Reducing adaptor, 3/8" F x 1/4" M | 1 | 144 | 911.3805 | 3/8" Spark plug socket, 21 mm | 1 | | | | |
| 115 | 911.1233 | Reducing adaptor, 1/2" F x 3/8" M | 1 | 145 | 914.1410 | Mini hand reversible ratchet, 1/4", 72 teethh | 1 | | | | |
| 116 | 911.4351 | 1/2" Bit adaptor socket, 1/2" x 5/16", 38 mm | 1 | 146 | 914.3810 | Mini hand reversible ratchet, 3/8", 72 teethh | 1 | | | | |
| 117 | 911.1436 | 1/4" Bit socket hexagon, 3 mm | 1 | 147 | 514.1106 | Socket adaptor, 1/4"x1/4" | 1 | | | | |
| 118 | 911.1437 | 1/4" Bit socket hexagon, 4 mm | 1 | | | | | | | | |
| 119 | 911.1438 | 1/4" Bit socket hexagon, 5 mm | 1 | | | | | | | | |
| 120 | 911.1439 | 1/4" Bit socket hexagon, 6 mm | 1 | | | | | | | | |

813.0085

L 1/2" Socket spanner set

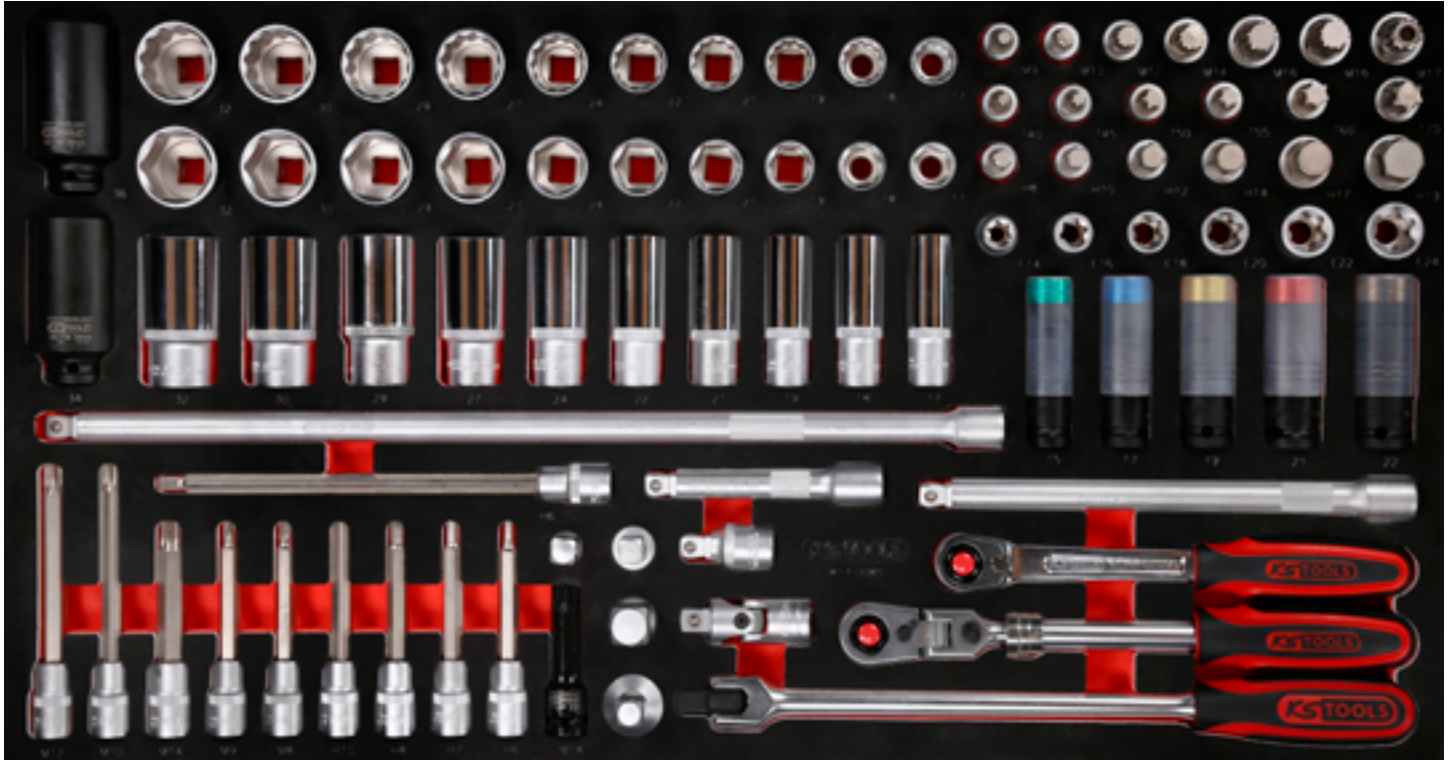

| Pos. | Code | Description | pcs | Pos. | Code | Description | pcs | Pos. | Code | Description | pcs |
|------|----------|------------------------------|-----|------|----------|--|-----|------|----------|--|-----|
| 1 | 911.1587 | 1/2" 12 Point socket, 32 mm | 1 | 17 | 917.1221 | 1/2" Hexagonal socket, 21 mm | 1 | 33 | 911.1313 | 1/2" Bit socket spline (XZN), M9, 55 mm | 1 |
| 2 | 911.1586 | 1/2" 12 Point socket, 30 mm | 1 | 18 | 917.1219 | 1/2" Hexagonal socket, 19 mm | 1 | 34 | 911.1343 | 1/2" Bit socket spline (XZN), M10, 55 mm | 1 |
| 3 | 917.1366 | 1/2" 12 Point socket, 29 mm | 1 | 19 | 917.1218 | 1/2" Hexagonal socket, 18 mm | 1 | 35 | 911.1344 | 1/2" Bit socket spline (XZN), M12, 55 mm | 1 |
| 4 | 911.1585 | 1/2" 12 Point socket, 27 mm | 1 | 20 | 917.1217 | 1/2" Hexagonal socket, 17 mm | 1 | 36 | 911.1345 | 1/2" Bit socket spline (XZN), M14, 55 mm | 1 |
| 5 | 911.1584 | 1/2" 12 Point socket, 24 mm | 1 | 21 | 150.1707 | Special drive shaft impact socket, 1/2", 36 mm | 1 | 37 | 911.1346 | 1/2" Bit socket spline (XZN), M16, 55 mm | 1 |
| 6 | 911.1582 | 1/2" 12 Point socket, 22 mm | 1 | 22 | 150.1704 | Special drive shaft impact socket, 1/2", 34 mm | 1 | 38 | 911.5306 | 1/2" Bit socket spline (XZN), M17, 55 mm | 1 |
| 7 | 911.1581 | 1/2" 12 Point socket, 21 mm | 1 | 23 | 917.1275 | 1/2" 12 Point socket, deep, 32 mm | 1 | 39 | 911.1348 | 1/2" Bit socket spline (XZN) tamperproof, M16, 55 mm | 1 |
| 8 | 911.1579 | 1/2" 12 Point socket, 19 mm | 1 | 24 | 917.1274 | 1/2" 12 Point socket, deep, 30 mm | 1 | 40 | 911.1365 | 1/2" Bit socket Torx, T40 | 1 |
| 9 | 911.1578 | 1/2" 12 Point socket, 18 mm | 1 | 25 | 917.5329 | 1/2" 12 Point socket, deep, 29 mm | 1 | 41 | 911.1366 | 1/2" Bit socket Torx, T45 | 1 |
| 10 | 911.1577 | 1/2" 12 Point socket, 17 mm | 1 | 26 | 917.1273 | 1/2" 12 Point socket, deep, 27 mm | 1 | 42 | 911.1367 | 1/2" Bit socket Torx, T50 | 1 |
| 11 | 917.1232 | 1/2" Hexagonal socket, 32 mm | 1 | 27 | 917.1272 | 1/2" 12 Point socket, deep, 24 mm | 1 | 43 | 911.1368 | 1/2" Bit socket Torx, T55 | 1 |
| 12 | 917.1230 | 1/2" Hexagonal socket, 30 mm | 1 | 28 | 917.1271 | 1/2" 12 Point socket, deep, 22 mm | 1 | 44 | 911.1369 | 1/2" Bit socket Torx, T60 | 1 |
| 13 | 917.1345 | 1/2" Hexagonal socket, 29 mm | 1 | 29 | 917.1270 | 1/2" 12 Point socket, deep, 21 mm | 1 | 45 | 911.1370 | 1/2" Bit socket Torx, T70 | 1 |
| 14 | 917.1227 | 1/2" Hexagonal socket, 27 mm | 1 | 30 | 917.1269 | 1/2" 12 Point socket, deep, 19 mm | 1 | 46 | 911.1308 | 1/2" Bit socket hexagon, short, 8 mm | 1 |
| 15 | 917.1224 | 1/2" Hexagonal socket, 24 mm | 1 | 31 | 917.1268 | 1/2" 12 Point socket, deep, 18 mm | 1 | 47 | 911.1310 | 1/2" Bit socket hexagon, short, 10 mm | 1 |
| 16 | 917.1222 | 1/2" Hexagonal socket, 22 mm | 1 | 32 | 917.1267 | 1/2" 12 Point socket, deep, 17 mm | 1 | | | | |

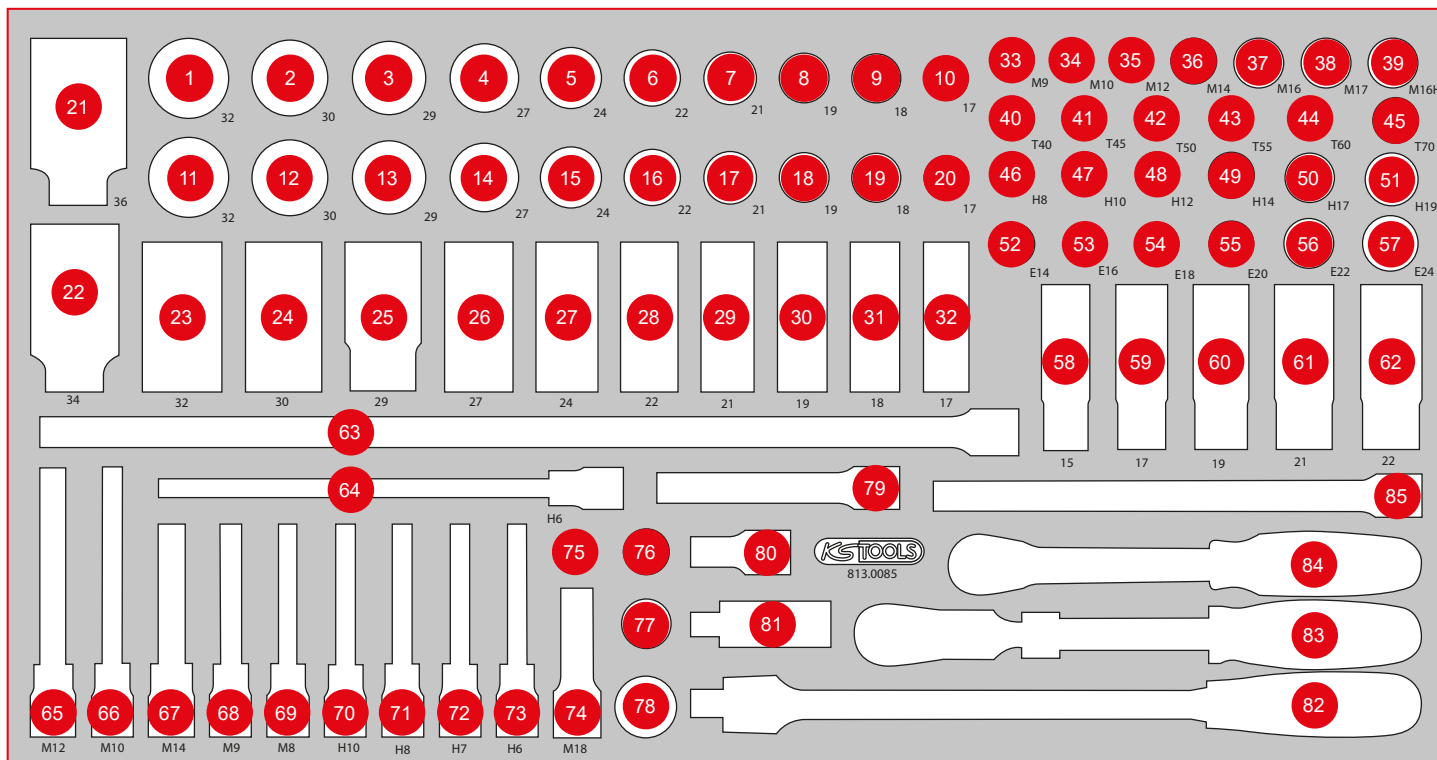

| Pos. | Code | Description | pcs | Pos. | Code | Description | pcs | Pos. | Code | Description | pcs |
|------|----------|--|-----|------|----------|---|-----|------|----------|--|-----|
| 48 | 911.1312 | 1/2" Bit socket hexagon, short, 12 mm | 1 | 62 | 515.0995 | SlimPOWER 1/2"Alloy rim impact socket, 22 mm | 1 | 77 | 911.1234 | Adaptor, 1/2" F x 3/4" M | 1 |
| 49 | 911.1314 | 1/2" Bit socket hexagon, short, 14 mm | 1 | 63 | 911.1836 | Wobble extension, 1/2", 500 mm | 1 | 78 | 911.3412 | Reducing adaptor 3/4" F x 1/2" M | 1 |
| 50 | 911.1317 | 1/2" Bit socket hexagon, short, 17 mm | 1 | 64 | 911.5313 | Hex bit socket, ball ended, long, 1/2", 6 mm | 1 | 79 | 911.1383 | Wobble extension, 1/2", 125 mm | 1 |
| 51 | 911.1319 | 1/2" Bit socket hexagon, short, 19 mm | 1 | 65 | 911.1972 | 1/2" Bit socket spline (XZN), M12, 140 mm | 1 | 80 | 911.1381 | Wobble extension, 1/2", 50 mm | 1 |
| 52 | 911.4336 | 1/2" Torx E Socket, E14 | 1 | 66 | 911.1970 | 1/2" Bit socket spline (XZN), M10, 140 mm | 1 | 81 | 911.1250 | 1/2" Universal joint | 1 |
| 53 | 911.4322 | 1/2" Torx E Socket, E16 | 1 | 67 | 911.1355 | 1/2" Bit socket spline (XZN), M14, 110 mm | 1 | 82 | 917.1455 | 1/2" Flexi head drive handle | 1 |
| 54 | 911.4323 | 1/2" Torx E Socket, E18 | 1 | 68 | 911.1359 | 1/2" Bit socket spline (XZN), M9, 110 mm | 1 | 83 | 914.1220 | 1/2" SlimPOWER Telescopic reversible ratchet, 72 teeth | 1 |
| 55 | 911.4324 | 1/2" Torx E Socket, E20 | 1 | 69 | 911.1352 | 1/2" Bit socket spline (XZN), M8, 110 mm | 1 | 84 | 920.1290 | 1/2" SlimPOWER Reversible ratchet, 72 teeth | 1 |
| 56 | 911.4325 | 1/2" Torx E Socket, E22 | 1 | 70 | 911.1660 | Hex bit socket, ball ended, long, 1/2", 10 mm | 1 | 85 | 911.1384 | Wobble extension, 1/2", 250 mm | 1 |
| 57 | 911.4326 | 1/2" Torx E Socket, E24 | 1 | 71 | 911.1658 | Hex bit socket, ball ended, long, 1/2", 8 mm | 1 | | | | |
| 58 | 515.0991 | SlimPOWER 1/2"Alloy rim impact socket, 15 mm | 1 | 72 | 911.1657 | Hex bit socket, ball ended, long, 1/2", 7 mm | 1 | | | | |
| 59 | 515.0992 | SlimPOWER 1/2"Alloy rim impact socket, 17 mm | 1 | 73 | 911.1656 | Hex bit socket, ball ended, long, 1/2", 6 mm | 1 | | | | |
| 60 | 515.0993 | SlimPOWER 1/2"Alloy rim impact socket, 19 mm | 1 | 74 | 515.1176 | 1/2" impact socket, XZN, M18 long | 1 | | | | |
| 61 | 515.0994 | SlimPOWER 1/2"Alloy rim impact socket, 21 mm | 1 | 75 | 911.3892 | Adaptor, 3/8" F x 1/2" M | 1 | | | | |
| | | | | 76 | 911.1207 | 3/8" Sliding adaptor, 3/8" F x 1/2" M | 1 | | | | |

813.0055

L Screw spanner set



755 x 398



P25



| Pos. | Code | Description | pcs | Pos. | Code | Description | pcs | Pos. | Code | Description | pcs |
|------|----------|-------------------------------------|-----|------|----------|---|-----|------|----------|--|-----|
| 1 | 517.0606 | Combination spanners, offset, 6 mm | 1 | 13 | 517.0618 | Combination spanners, offset, 18 mm | 1 | 25 | 911.0374 | Double ring spanner for Torx E profile, E14 x E18 | 1 |
| 2 | 517.0607 | Combination spanners, offset, 7 mm | 1 | 14 | 517.0619 | Combination spanners, offset, 19 mm | 1 | 26 | 911.0375 | Double ring spanner for Torx E profile, E16 x E22 | 1 |
| 3 | 517.0608 | Combination spanners, offset, 8 mm | 1 | 15 | 517.0620 | Combination spanners, offset, 20 mm | 1 | 27 | 911.0376 | Double ring spanner for Torx E profile, E20 x E24 | 1 |
| 4 | 517.0609 | Combination spanners, offset, 9 mm | 1 | 16 | 517.0621 | Combination spanners, offset, 21 mm | 1 | 28 | 503.4608 | GEARplus reversing combination ratcheting spanner, 8 mm | 1 |
| 5 | 517.0610 | Combination spanners, offset, 10 mm | 1 | 17 | 517.0622 | Combination spanners, offset, 22 mm | 1 | 29 | 503.4609 | GEARplus reversing combination ratcheting spanner, 9 mm | 1 |
| 6 | 517.0611 | Combination spanners, offset, 11 mm | 1 | 18 | 517.0624 | Combination spanners, offset, 24 mm | 1 | 30 | 503.4610 | GEARplus reversing combination ratcheting spanner, 10 mm | 1 |
| 7 | 517.0612 | Combination spanners, offset, 12 mm | 1 | 19 | 517.0627 | Combination spanners, offset, 27 mm | 1 | 31 | 503.4611 | GEARplus reversing combination ratcheting spanner, 11 mm | 1 |
| 8 | 517.0613 | Combination spanners, offset, 13 mm | 1 | 20 | 517.0630 | Combination spanners, offset, 30 mm | 1 | | | | |
| 9 | 517.0614 | Combination spanners, offset, 14 mm | 1 | 21 | 517.0632 | Combination spanners, offset, 32 mm | 1 | | | | |
| 10 | 517.0615 | Combination spanners, offset, 15 mm | 1 | 22 | 911.0371 | Double ring spanner for Torx E profile, E6 x E8 | 1 | | | | |
| 11 | 517.0616 | Combination spanners, offset, 16 mm | 1 | 23 | 911.0372 | Double ring spanner for Torx E profile, E7 x E11 | 1 | | | | |
| 12 | 517.0617 | Combination spanners, offset, 17 mm | 1 | 24 | 911.0373 | Double ring spanner for Torx E profile, E10 x E12 | 1 | | | | |

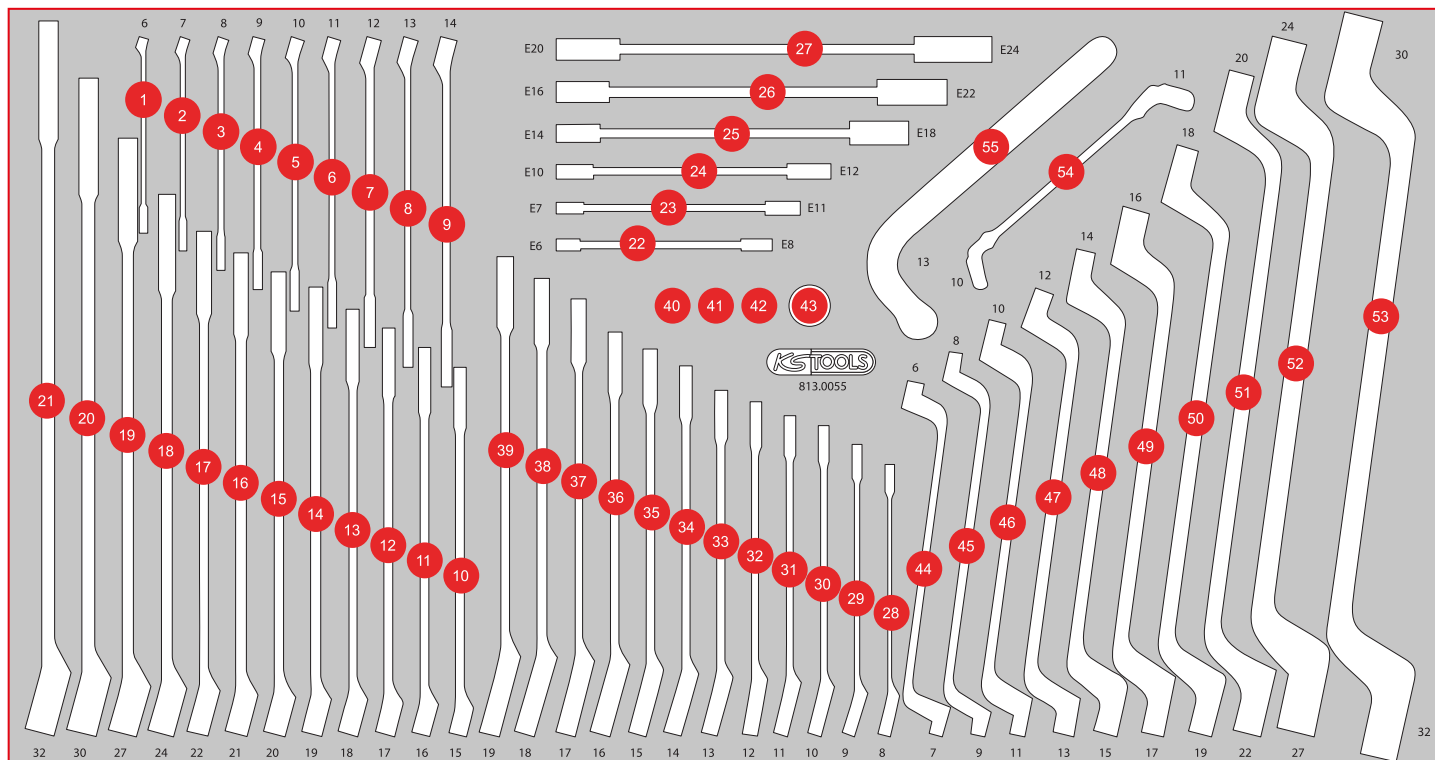

| Pos. | Code | Description | pcs | Pos. | Code | Description | pcs | Pos. | Code | Description | pcs |
|------|----------|--|-----|------|----------|--|-----|------|----------|--|-----|
| 32 | 503.4612 | GEARplus reversing combination ratcheting spanner, 12 mm | 1 | 38 | 503.4618 | GEARplus reversing combination ratcheting spanner, 18 mm | 1 | 47 | 517.0807 | Double ring spanner, offset, 12 x 13 mm | 1 |
| 33 | 503.4613 | GEARplus reversing combination ratcheting spanner, 13 mm | 1 | 39 | 503.4619 | GEARplus reversing combination ratcheting spanner, 19 mm | 1 | 48 | 517.0809 | Double ring spanner, offset, 14 x 15 mm | 1 |
| 34 | 503.4614 | GEARplus reversing combination ratcheting spanner, 14 mm | 1 | 40 | 503.4290 | GEARplus bit adaptor, 1/4" x 10 mm | 1 | 49 | 517.0810 | Double ring spanner, offset, 16 x 17 mm | 1 |
| 35 | 503.4615 | GEARplus reversing combination ratcheting spanner, 15 mm | 1 | 41 | 503.4296 | GEARplus socket adaptor, 1/4" x 10 mm | 1 | 50 | 517.0812 | Double ring spanner, offset, 18 x 19 mm | 1 |
| 36 | 503.4616 | GEARplus reversing combination ratcheting spanner, 16 mm | 1 | 42 | 503.4297 | GEARplus socket adaptor, 3/8" x 13 mm | 1 | 51 | 517.0813 | Double ring spanner, offset, 20 x 22 mm | 1 |
| 37 | 503.4617 | GEARplus reversing combination ratcheting spanner, 17 mm | 1 | 43 | 503.4298 | GEARplus socket adaptor, 1/2" x 19 mm | 1 | 52 | 517.0816 | Double ring spanner, offset, 24 x 27 mm | 1 |
| | | | | 44 | 517.0801 | Double ring spanner, offset, 6 x 7 mm | 1 | 53 | 517.0818 | Double ring spanner, offset, 30 x 32 mm | 1 |
| | | | | 45 | 517.0802 | Double ring spanner, offset, 8 x 9 mm | 1 | 54 | 518.0528 | Open double ring spanner, with double joint, 10 x 11 | 1 |
| | | | | 46 | 517.0804 | Double ring spanner, offset, 10 x 11 mm | 1 | 55 | 152.1396 | Injector pump wrench, 13 mm | 1 |

813.0024

L T-handle angle wrench and screwdriver set

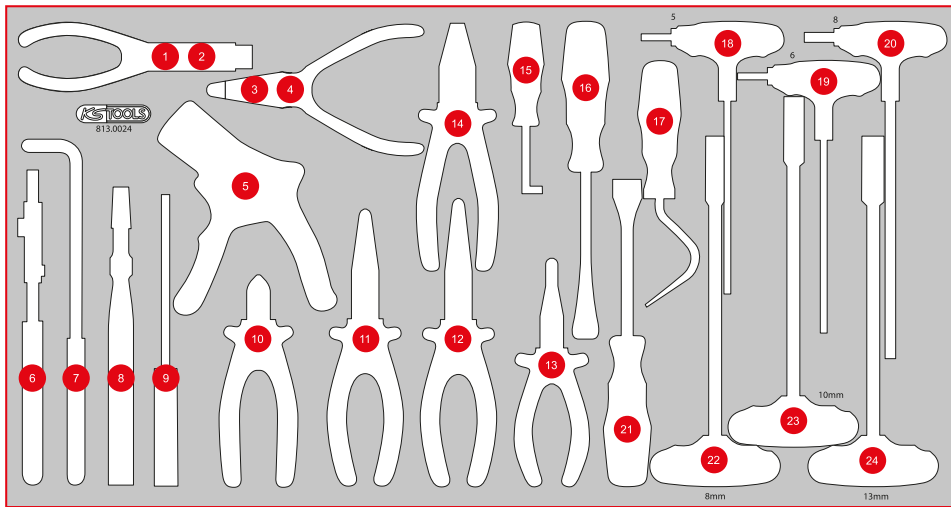

| Pos. | Code | Description | pcs |
|------|----------|--|-----|
| 1 | 500.1035 | Circlip pliers for internal circlips, 160 mm | 1 |
| 2 | 500.1032 | Circlip pliers for internal circlips, angled, 160 mm | 1 |
| 3 | 500.1029 | Circlip pliers for external circlips, 160 mm | 1 |
| 4 | 500.1026 | Circlip pliers for external circlips, angled, 160 mm | 1 |
| 5 | 115.1239 | Self regulating wire stripper, 0,2-6 mm | 1 |
| 6 | 115.2010 | Water pump pliers, 240 mm | 1 |
| 7 | 500.7053 | Telephone pliers 90° curved, extra long, 270 mm | 1 |
| 8 | 115.1033 | Self grip wrench, 220 mm | 1 |
| 9 | 115.1231 | Multifunction pliers for insulated and non insulated cable terminals, 220 mm | 1 |
| 10 | 115.1012 | ERGOTORQUE diagonal side cutter, 160 mm | 1 |
| 11 | 115.1019 | ERGOTORQUE bent nose pliers serrated, 210 mm | 1 |
| 12 | 115.1024 | ERGOTORQUE long nose pliers serrated cutter, 200 mm | 1 |
| 13 | 115.1016 | ERGOTORQUE flat pliers serrated, 160 mm | 1 |
| 14 | 115.1021 | ERGOTORQUE combination pliers, 180 mm | 1 |
| 15 | 550.1048 | Hook, 90° offset | 1 |
| 16 | 140.2373 | Clip remover short, length 245 mm, Opening 10 mm | 1 |
| 17 | 550.1073 | Hook, large, sickle | 1 |
| 18 | 151.8134 | T-handle ball ended hexagon key wrench, 5 mm | 1 |
| 19 | 151.8135 | T-handle ball ended hexagon key wrench, 6 mm | 1 |
| 20 | 151.8137 | T-handle ball ended hexagon key wrench, 8 mm | 1 |
| 21 | 140.2616 | Clip remover, short 7,5 mm | 1 |
| 22 | 158.5008 | T-handle socket screwdriver, long, 8 mm | 1 |
| 23 | 158.5010 | T-handle socket screwdriver, long, 10 mm | 1 |
| 24 | 158.5013 | T-handle socket screwdriver, long, 13 mm | 1 |

813.1036

L Hammer, chisel and measuring tool set

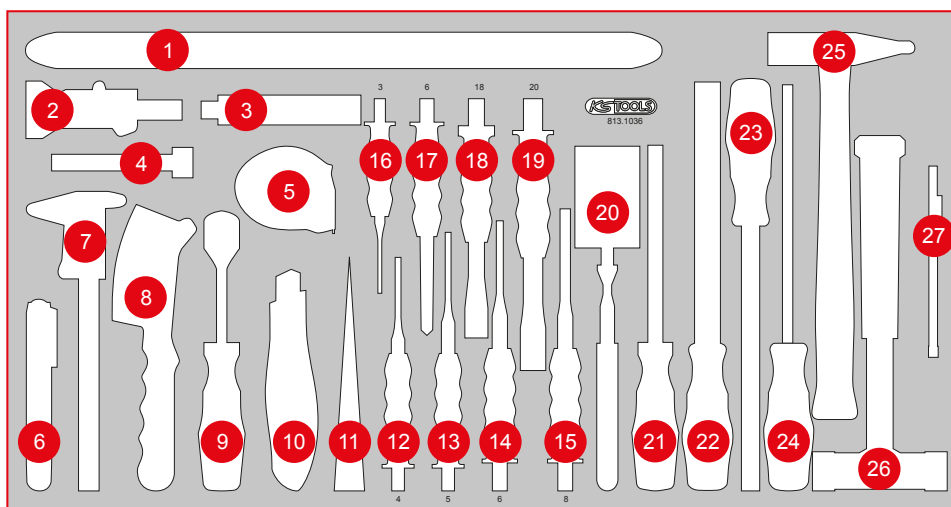

| Pos. | Code | Description | pcs |
|------|----------|---|-----|
| 1 | 911.8199 | Tyre iron for installing and removing tyres with replaceable plastic coating, 500 mm | 1 |
| 2 | 300.0550 | Digital depth gauge 0-25 mm, 125 mm | 1 |
| 3 | 907.2206 | Trapezoid blades, pack of 10 | 10 |
| 4 | 300.0600 | Feeler gauge, 20 Blades, 0,05 - 1 mm | 1 |
| 5 | 300.0114 | Tape measure with locking device and belt clip, black red, 5 m, 19 mm | 1 |
| 6 | 150.2199 | Brake fluid tester | 1 |
| 7 | 300.0510 | Pocket vernier calliper 0-150 mm, 235 mm | 1 |
| 8 | 201.2320 | Steel wire brake saddle wire brush 2 rowed, straight | 1 |
| 9 | 907.2222 | Gasket scraper, 25 x 200 mm | 1 |
| 10 | 907.2140 | Professional safety universal knife, 145 mm | 1 |
| 11 | 911.8138 | Trim plastic wedge, 195 mm x B = 30 mm | 1 |
| 12 | 156.0232 | Pin punch, Ø 4 mm, cylindrical shaft | 1 |
| 13 | 156.0233 | Pin punch, Ø 5 mm, cylindrical shaft | 1 |
| 14 | 156.0234 | Pin punch, Ø 6 mm, cylindrical shaft | 1 |
| 15 | 156.0235 | Pin punch, Ø 8 mm, cylindrical shaft | 1 |
| 16 | 156.0231 | Pin punch, Ø 3 mm, cylindrical shaft | 1 |
| 17 | 156.0243 | Centre punch, octagon 10 mm | 1 |
| 18 | 156.0241 | Flat chisel, octagon, 20 mm | 1 |
| 19 | 156.0254 | Flat chisel, octagon, 18 mm | 1 |
| 20 | 550.1136 | Flexible inspection mirror with lighting | 1 |
| 21 | 157.0960 | Brake saddle file, extra narrow, 270 mm | 1 |
| 22 | 157.0105 | Halfround file, form E, cut 2, 20 mm | 1 |
| 23 | 157.0405 | Tri-bastard file, form C, cut 2, 200 mm | 1 |
| 24 | 157.0205 | Round file, form F, cut 2, 200 mm | 1 |
| 25 | 142.1402 | Fitters Hammer, fibreglas handle, 400 g | 1 |
| 26 | 140.5271 | Recoil free soft faced Hammer, 480 g | 1 |
| 27 | 550.1001 | 2 in 1 Telescopic solenoid holder with washer jet cleaning and setting tool, 150 - 675 mm | 1 |



873.7014-R101P...R200P
Replacement key for lock number xyz



873.7014-R201P...R300P
Lock with 2 keys, lock number xyz



873.3008-R008P
Full extension (with ball-bearing guide) with automatic retraction, right



873.3008-R009P
Full extension with self-closing, for drawer, left

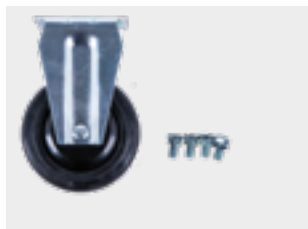

873.5008-R009P
Fixed castors, incl. screws



873.5008-R011P
Swivel castors with brakes, incl. screws



873.5008-R014P
Roller set, incl. screws



873.3008-R007P
Stainless steel work surface



873.3008-R006P
Storage for work surface, including screw cover, usable on both sides



873.3008-R005P
Compartment with website and ball-bearing guide, 755x398x65 mm



873.3008-R004P
Compartment with ball-bearing guide, 755x398x65 mm



873.3008-R003P
Compartment with logo and ball-bearing guide, 755x398x145 mm



873.5008-R002P
Can holder including screws, W = 310 mm



873.3008-R002P
Paper roll holder including screws, W= 320 mm



873.4008-R005P
Plastic bumpers, front left, back right



873.4008-R002P
Plastic bumpers, front right, back left

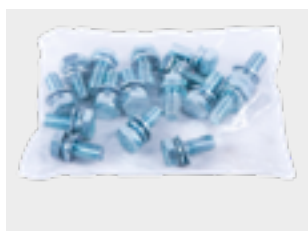

873.7014-R004P
M8 screws (16 pcs.)



873.7014-R003P
M6x12 screw (1 pcs.)



873.3008-R001P
Body of workshop trolley attachment



Enough spares for
your treasure!