

# P15

**workshop tool trolley**  
with 366 tools for 6 drawers  
**815.6366**

# THE COMPACT HEAVYWEIGHT

P15



**Workshop trolley P15**  
with 8 compartments  
873.1008



**DUO Lock** Brilliant locking system



**Eight drawers** each load capacity up to 50 kg



Stable **ball bearing**



**Plastic Surface**

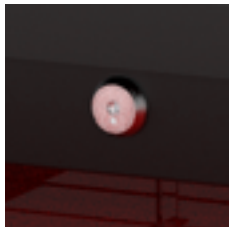

**Lock** lockable

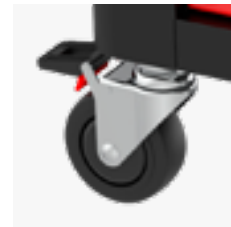

**Anti-static castors** with brakes



Integrated **corner protection**



**Paper roll holder** included



**Can holder** included

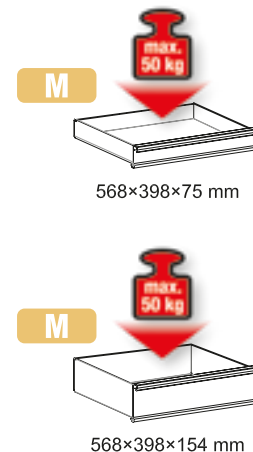
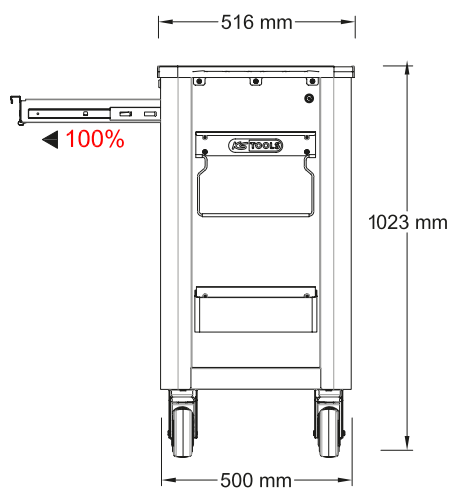
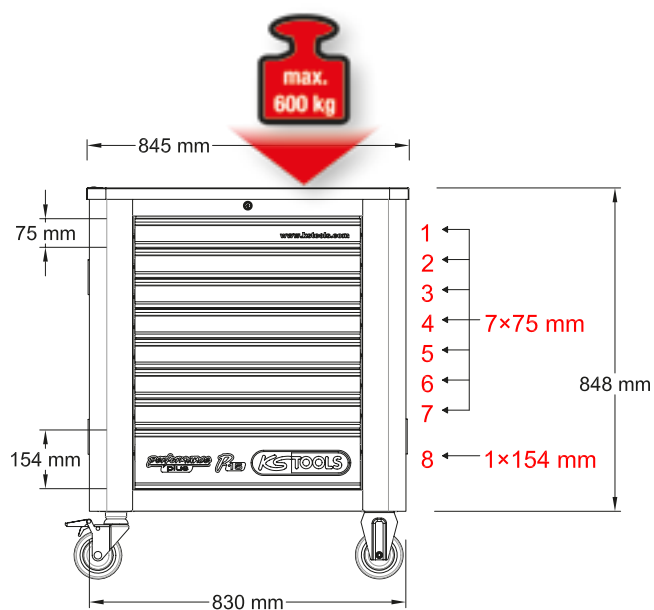

# P15 workshop tool trolley set with 366 tools for 6 drawers

815.6366



M

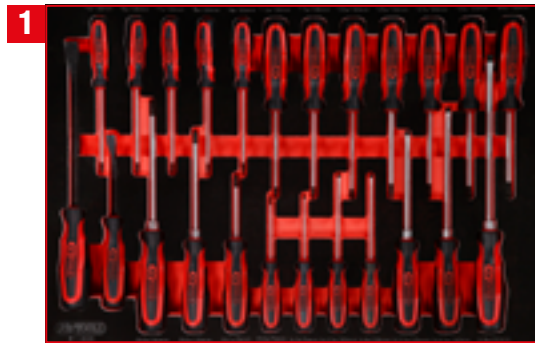

IPCS  
24

Screwdriver set in foam insert

811.0024



IPCS  
139

1/4" + 3/8" + 1/2" socket spanner set in foam insert

811.0139

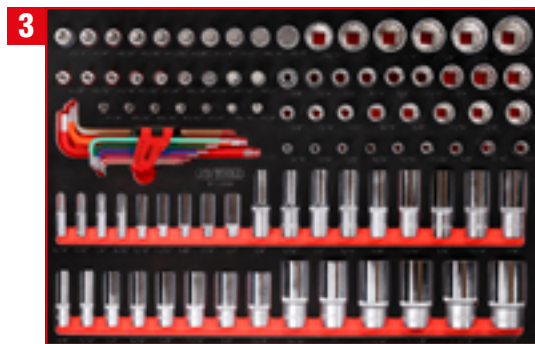

IPCS  
99

1/4" + 3/8" + 1/2" socket spanner set in foam insert

811.0099

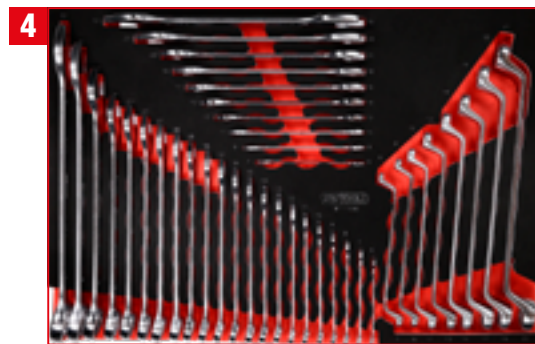

IPCS  
40

Screw spanner set in foam insert

811.1040



IPCS  
31

Screw spanner set in foam insert

811.0031



IPCS  
33

Pliers, hammer and chisel set in foam insert

811.0033

811.0024

**M** Screwdriver set

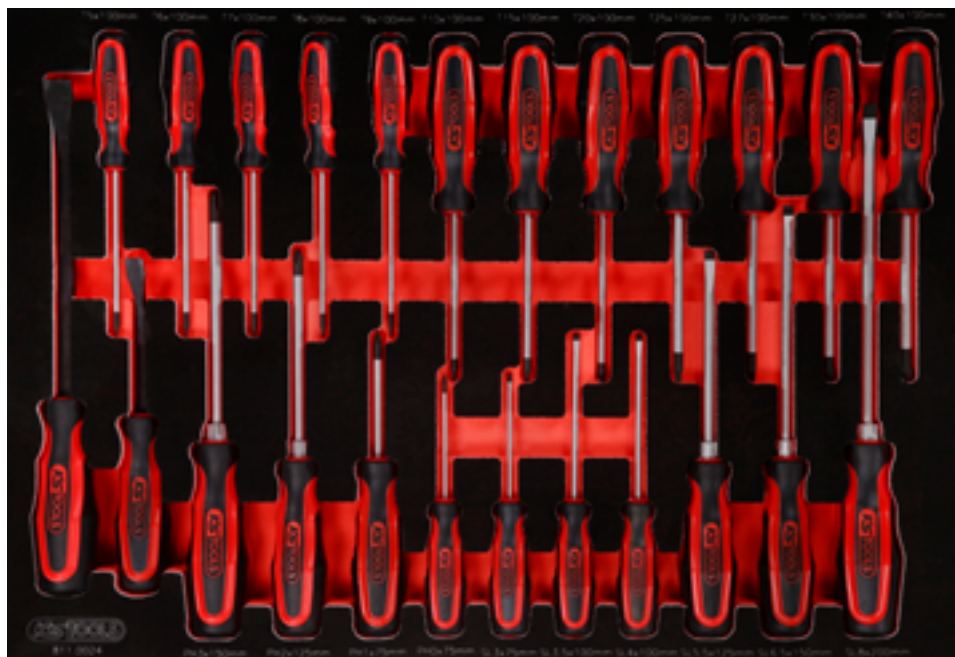

Pos.	Code	Description	pcs
1	911.8102	Pry bar, 15 x 185 mm	1
2	911.8101	Pry bar, 11 x 115 mm	1
3	159.1133	ERGOTORQUEplus screwdriver, Torx, T5	1
4	159.1134	ERGOTORQUEplus screwdriver, Torx, T6	1
5	159.1135	ERGOTORQUEplus screwdriver, Torx, T7	1
6	159.1030	ERGOTORQUEplus screwdriver, Torx, T8	1
7	159.1031	ERGOTORQUEplus screwdriver, Torx, T9	1
8	159.1032	ERGOTORQUEplus screwdriver, Torx, T10	1
9	159.1033	ERGOTORQUEplus screwdriver, Torx, T15	1
10	159.1034	ERGOTORQUEplus screwdriver, Torx, T20	1
11	159.1035	ERGOTORQUEplus screwdriver, Torx, T25	1
12	159.1036	ERGOTORQUEplus screwdriver, Torx, T27	1
13	159.1037	ERGOTORQUEplus screwdriver, Torx, T30	1
14	159.1038	ERGOTORQUEplus screwdriver, Torx, T40	1
15	159.1024	ERGOTORQUEplus screwdriver, Torx, PH3, 265 mm	1
16	159.1022	ERGOTORQUEplus screwdriver, Torx, PH2, 230 mm	1
17	159.1020	ERGOTORQUEplus screwdriver, Torx, PH1, 180 mm	1
18	159.1027	ERGOTORQUEplus screwdriver, Torx, PH0, 155 mm	1
19	159.1002	ERGOTORQUEplus screwdriver for slotted screws, 3 mm, 155 mm	1
20	159.1112	ERGOTORQUEplus screwdriver for slotted screws, 3,5 mm, 180 mm	1
21	159.1004	ERGOTORQUEplus screwdriver for slotted screws, 4 mm, 180 mm	1
22	159.1006	ERGOTORQUEplus screwdriver for slotted screws, 5,5 mm, 230 mm	1
23	159.1009	ERGOTORQUEplus screwdriver for slotted screws, 6,5 mm, 255 mm	1
24	159.1011	ERGOTORQUEplus screwdriver for slotted screws, 8 mm, 315 mm	1

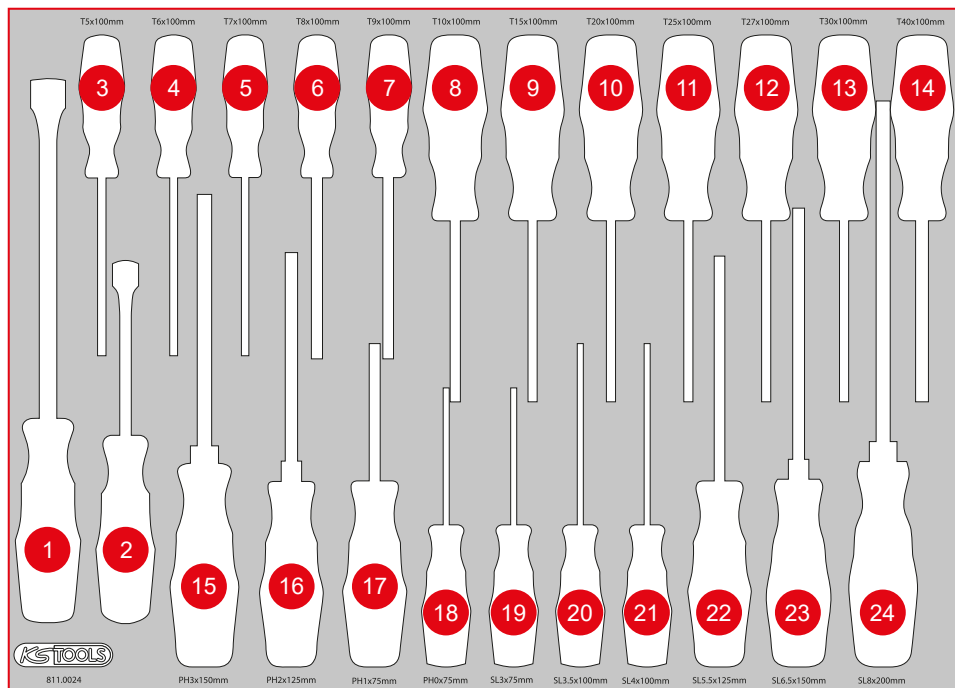

**M** 1/4" + 3/8" + 1/2" Socket spanner set

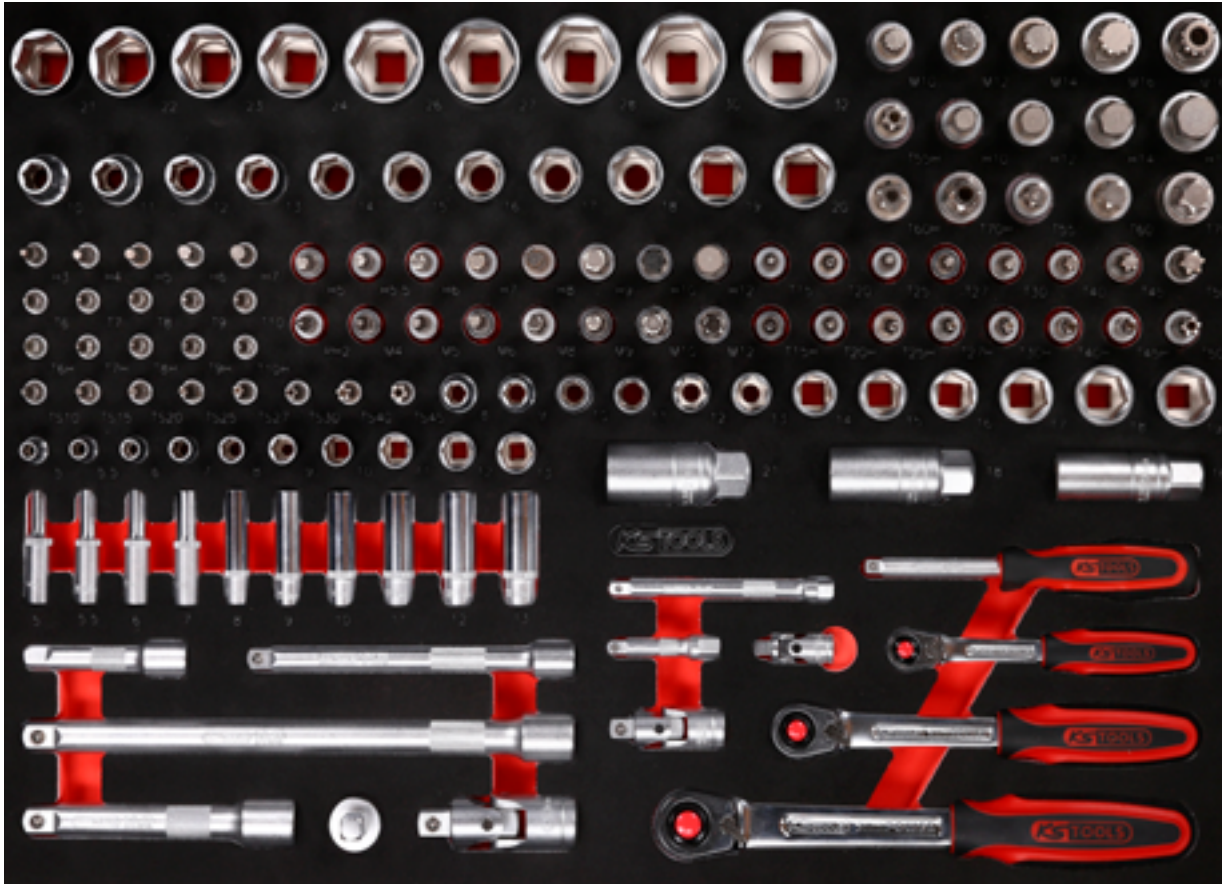

Pos.	Code	Description	pcs	Pos.	Code	Description	pcs	Pos.	Code	Description	pcs
1	917.1221	1/2" Hexagonal socket, 21 mm	1	25	911.1348	1/2" Bit socket spline (XZN) tamperproof, M16, 55 mm	1	48	911.1461	1/4" Bit socket Torx tamperproof, TB8	1
2	917.1222	1/2" Hexagonal socket, 22 mm	1	26	911.1378	1/2" Bit socket Torx tamperproof, TB55	1	49	911.1485	1/4" Bit socket Torx tamperproof, TB9	1
3	917.1223	1/2" Hexagonal socket, 23 mm	1	27	911.1310	1/2" Bit socket hexagon, short, 10 mm	1	50	911.1462	1/4" Bit socket Torx tamperproof, TB10	1
4	917.1224	1/2" Hexagonal socket, 24 mm	1	28	911.1312	1/2" Bit socket hexagon, short, 12 mm	1	51	911.1701	1/4" Bit socket five star tamperproof, TS10	1
5	917.1343	1/2" Hexagonal socket, 26 mm	1	29	911.1314	1/2" Bit socket hexagon, short, 14 mm	1	52	911.1702	1/4" Bit socket five star tamperproof, TS15	1
6	917.1227	1/2" Hexagonal socket, 27 mm	1	30	911.1317	1/2" Bit socket hexagon, short, 17 mm	1	53	911.1703	1/4" Bit socket five star tamperproof, TS20	1
7	917.1344	1/2" Hexagonal socket, 28 mm	1	31	911.1379	1/2" Bit socket Torx tamperproof, TB60	1	54	911.1704	1/4" Bit socket five star tamperproof, TS25	1
8	917.1230	1/2" Hexagonal socket, 30 mm	1	32	911.1380	1/2" Bit socket Torx tamperproof, TB70	1	55	911.1705	1/4" Bit socket five star tamperproof, TS27	1
9	917.1232	1/2" Hexagonal socket, 32 mm	1	33	911.1368	1/2" Bit socket Torx, T55	1	56	911.1706	1/4" Bit socket five star tamperproof, TS30	1
10	917.1210	1/2" Hexagonal socket, 10 mm	1	34	911.1369	1/2" Bit socket Torx, T60	1	57	911.1707	1/4" Bit socket five star tamperproof, TS40	1
11	917.1211	1/2" Hexagonal socket, 11 mm	1	35	911.1370	1/2" Bit socket Torx, T70	1	58	911.1708	1/4" Bit socket five star tamperproof, TS45	1
12	917.1212	1/2" Hexagonal socket, 12 mm	1	36	911.1436	1/4" Bit socket hexagon, 3 mm	1	59	911.3865	3/8" Bit socket hexagon, 5 mm	1
13	917.1213	1/2" Hexagonal socket, 13 mm	1	37	911.1437	1/4" Bit socket hexagon, 4 mm	1	60	911.38655	3/8" Bit socket hexagon, 5,5 mm	1
14	917.1214	1/2" Hexagonal socket, 14 mm	1	38	911.1438	1/4" Bit socket hexagon, 5 mm	1	61	911.3866	3/8" Bit socket hexagon, 6 mm	1
15	917.1215	1/2" Hexagonal socket, 15 mm	1	39	911.1439	1/4" Bit socket hexagon, 6 mm	1	62	911.3867	3/8" Bit socket hexagon, 7 mm	1
16	917.1216	1/2" Hexagonal socket, 16 mm	1	40	911.1440	1/4" Bit socket hexagon, 7 mm	1	63	911.3868	3/8" Bit socket hexagon, 8 mm	1
17	917.1217	1/2" Hexagonal socket, 17 mm	1	41	911.4407	1/4" Bit socket Torx, T6	1	64	917.3969	3/8" Bit socket hexagon, 9 mm	1
18	917.1218	1/2" Hexagonal socket, 18 mm	1	42	911.4362	1/4" Bit socket Torx, T7	1	65	917.3857	3/8" Bit socket hexagon, 10 mm	1
19	917.1219	1/2" Hexagonal socket, 19 mm	1	43	911.1448	1/4" Bit socket Torx, T8	1	66	911.3862	3/8" Bit socket hexagon, 12 mm	1
20	917.1220	1/2" Hexagonal socket, 20 mm	1	44	911.1478	1/4" Bit socket Torx, T9	1	67	911.3869	3/8" Bit socket Torx, T15	1
21	911.1343	1/2" Bit socket spline (XZN), M10, 55 mm	1	45	911.1442	1/4" Bit socket Torx, T10	1	68	911.3870	3/8" Bit socket Torx, T20	1
22	911.1344	1/2" Bit socket spline (XZN), M12, 55 mm	1	46	917.1456	1/4" Bit socket Torx tamperproof, TB6	1	69	911.3871	3/8" Bit socket Torx, T25	1
23	911.1345	1/2" Bit socket spline (XZN), M14, 55 mm	1	47	917.1457	1/4" Bit socket Torx tamperproof, TB7	1	70	911.3872	3/8" Bit socket Torx, T27	1
24	911.1346	1/2" Bit socket spline (XZN), M16, 55 mm	1					71	911.3873	3/8" Bit socket Torx, T30	1

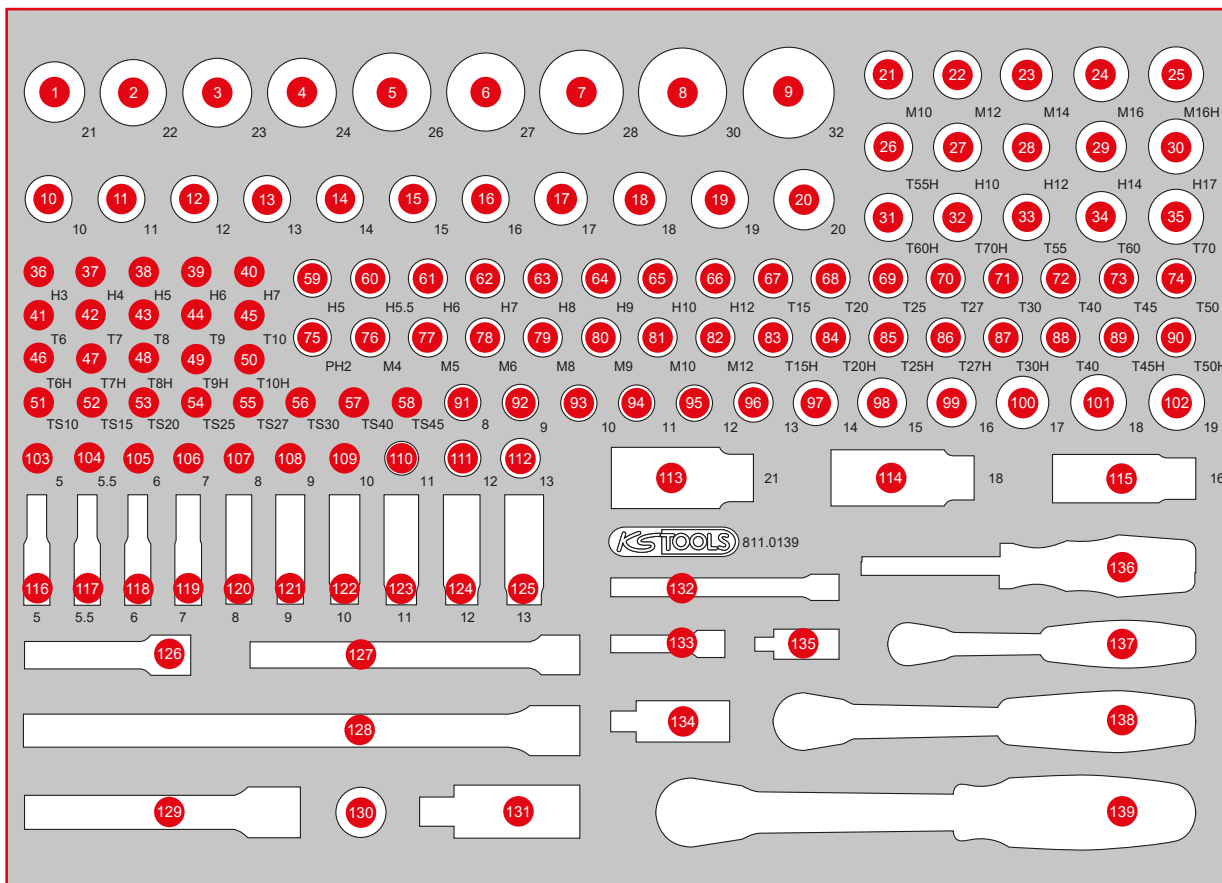

Pos.	Code	Description	pcs	Pos.	Code	Description	pcs	Pos.	Code	Description	pcs
72	911.3874	3/8" Bit socket Torx, T40	1	96	917.3813	3/8" Hexagonal socket, 13 mm	1	120	917.1428	1/4" Hexagonal socket, deep, 8 mm	1
73	911.3885	3/8" Bit socket Torx, T45	1	97	917.3814	3/8" Hexagonal socket, 14 mm	1	121	917.1429	1/4" Hexagonal socket, deep, 9 mm	1
74	911.3884	3/8" Bit socket Torx, T50	1	98	917.3815	3/8" Hexagonal socket, 15 mm	1	122	917.1430	1/4" Hexagonal socket, deep, 10 mm	1
75	911.3876	3/8" Bit socket, PH2	1	99	917.3816	3/8" Hexagonal socket, 16 mm	1	123	917.1431	1/4" Hexagonal socket, deep, 11 mm	1
76	911.3918	3/8" Bit socket spline (XZN), M4	1	100	917.3817	3/8" Hexagonal socket, 17 mm	1	124	917.1432	1/4" Hexagonal socket, deep, 12 mm	1
77	911.3915	3/8" Bit socket spline (XZN), M5	1	101	917.3818	3/8" Hexagonal socket, 18 mm	1	125	917.1433	1/4" Hexagonal socket, deep, 13 mm	1
78	911.3916	3/8" Bit socket spline (XZN), M6	1	102	917.3819	3/8" Hexagonal socket, 19 mm	1	126	911.3801	3/8" Extension with knurling, 75 mm	1
79	911.3917	3/8" Bit socket spline (XZN), M8	1	103	917.1405	1/4" Hexagonal socket, 5 mm	1	127	911.3802	3/8" Extension with knurling, 150 mm	1
80	917.3901	3/8" Bit socket spline (XZN), M9	1	104	917.14055	1/4" Hexagonal socket, 5.5 mm	1	128	911.1203	1/2" Extensions, 250 mm	1
81	911.3920	3/8" Bit socket spline (XZN), M10	1	105	917.1406	1/4" Hexagonal socket, 6 mm	1	129	911.1202	1/2" Extensions, 125 mm	1
82	917.3903	3/8" Bit socket spline (XZN), M12	1	106	917.1407	1/4" Hexagonal socket, 7 mm	1	130	911.1207	3/8" Sliding adaptor, 3/8" F x 1/2" M	1
83	911.3961	3/8" Bit socket Torx tamperproof, TB15	1	107	917.1408	1/4" Hexagonal socket, 8 mm	1	131	911.1250	1/2" Universal joint	1
84	911.3962	3/8" Bit socket Torx tamperproof, TB20	1	108	917.1409	1/4" Hexagonal socket, 9 mm	1	132	911.1424	1/4" Extension with hexagon drive, 100 mm	1
85	911.3963	3/8" Bit socket Torx tamperproof, TB25	1	109	917.1410	1/4" Hexagonal socket, 10 mm	1	133	911.1423	1/4" Extension with hexagon drive, 50 mm	1
86	911.3964	3/8" Bit socket Torx tamperproof, TB27	1	110	917.1411	1/4" Hexagonal socket, 11 mm	1	134	911.3850	3/8" Universal joint	1
87	911.3965	3/8" Bit socket Torx tamperproof, TB30	1	111	917.1412	1/4" Hexagonal socket, 12 mm	1	135	911.1450	1/4" Universal joint	1
88	911.3966	3/8" Bit socket Torx tamperproof, TB40	1	112	917.1413	1/4" Hexagonal socket, 13 mm	1	136	911.1434	1/4" Square drive screwdriver, 150 mm	1
89	911.3967	3/8" Bit socket Torx tamperproof, TB45	1	113	911.3805	3/8" Spark plug socket, 21 mm	1	137	920.1490	1/4" SlimPOWER Reversible ratchet, 72 teeth	1
90	911.3968	3/8" Bit socket Torx tamperproof, TB50	1	114	911.3823	3/8" Spark plug socket, 18 mm	1	138	920.3890	3/8" SlimPOWER Reversible ratchet, 72 teeth	1
91	917.3808	3/8" Hexagonal socket, 8 mm	1	115	911.3804	3/8" Spark plug socket, 16 mm	1	139	920.1290	1/2" SlimPOWER Reversible ratchet, 72 teeth	1
92	917.3809	3/8" Hexagonal socket, 9 mm	1	116	917.1527	1/4" Hexagonal socket, deep, 5 mm	1				
93	917.3810	3/8" Hexagonal socket, 10 mm	1	117	917.1528	1/4" Hexagonal socket, deep, 5.5 mm	1				
94	917.3811	3/8" Hexagonal socket, 11 mm	1	118	917.1426	1/4" Hexagonal socket, deep, 6 mm	1				
95	917.3812	3/8" Hexagonal socket, 12 mm	1	119	917.1427	1/4" Hexagonal socket, deep, 7 mm	1				

811.0099

**M** 1/4" + 3/8" + 1/2" Socket spanner set



Pos.	Code	Description	pcs	Pos.	Code	Description	pcs	Pos.	Code	Description	pcs
1	917.1316	1/2" Bit socket hexagon, short, 3/16"	1	16	917.3965	3/8" Bit socket hexagon, 5/16"	1	31	917.1386	1/2" 12 Point socket, 1.3/16"	1
2	917.1318	1/2" Bit socket hexagon, short, 1/4"	1	17	917.3966	3/8" Bit socket hexagon, 3/8"	1	32	917.1387	1/2" 12 Point socket, 1.1/4"	1
3	917.1319	1/2" Bit socket hexagon, short, 9/32"	1	18	917.3993	3/8" Bit socket hexagon, 7/16"	1	33	917.1370	1/2" 12 Point socket, 3/8"	1
4	917.1320	1/2" Bit socket hexagon, short, 5/16"	1	19	917.3994	3/8" Bit socket hexagon, 1/2"	1	34	917.1372	1/2" 12 Point socket, 7/16"	1
5	911.5386	1/2" Bit socket hexagon, short, 11/32"	1	20	917.1440	1/4" Bit socket hexagon, 1/8"	1	35	917.1373	1/2" 12 Point socket, 1/2"	1
6	917.1321	1/2" Bit socket hexagon, short, 3/8"	1	21	917.1441	1/4" Bit socket hexagon, 5/32"	1	36	917.1374	1/2" 12 Point socket, 9/16"	1
7	911.5387	1/2" Bit socket hexagon, short, 7/16"	1	22	917.1442	1/4" Bit socket hexagon, 3/16"	1	37	917.1376	1/2" 12 Point socket, 5/8"	1
8	917.1322	1/2" Bit socket hexagon, short, 1/2"	1	23	917.1443	1/4" Bit socket hexagon, 7/32"	1	38	917.1377	1/2" 12 Point socket, 11/16"	1
9	917.1323	1/2" Bit socket hexagon, short, 9/16"	1	24	917.1444	1/4" Bit socket hexagon, 1/4"	1	39	917.1378	1/2" 12 Point socket, 3/4"	1
10	917.1324	1/2" Bit socket hexagon, short, 5/8"	1	25	917.1501	1/4" Bit socket hexagon, 5/16"	1	40	917.1380	1/2" 12 Point socket, 13/16"	1
11	917.3967	3/8" Bit socket hexagon, 1/8"	1	26	917.1502	1/4" Bit socket hexagon, 3/8"	1	41	917.1381	1/2" 12 Point socket, 7/8"	1
12	917.3962	3/8" Bit socket hexagon, 5/32"	1	27	917.1382	1/2" 12 Point socket, 15/16"	1	42	917.3851	3/8" 12 Point socket, 3/8"	1
13	917.3963	3/8" Bit socket hexagon, 3/16"	1	28	917.1383	1/2" 12 Point socket, 1"	1	43	917.3852	3/8" 12 Point socket, 7/16"	1
14	917.3968	3/8" Bit socket hexagon, 7/32"	1	29	917.1384	1/2" 12 Point socket, 1.1/16"	1	44	911.4000	3/8" 12 Point socket, 1/2"	1
15	917.3964	3/8" Bit socket hexagon, 1/4"	1	30	917.1385	1/2" 12 Point socket, 1.1/8"	1	45	911.4001	3/8" 12 Point socket, 9/16"	1



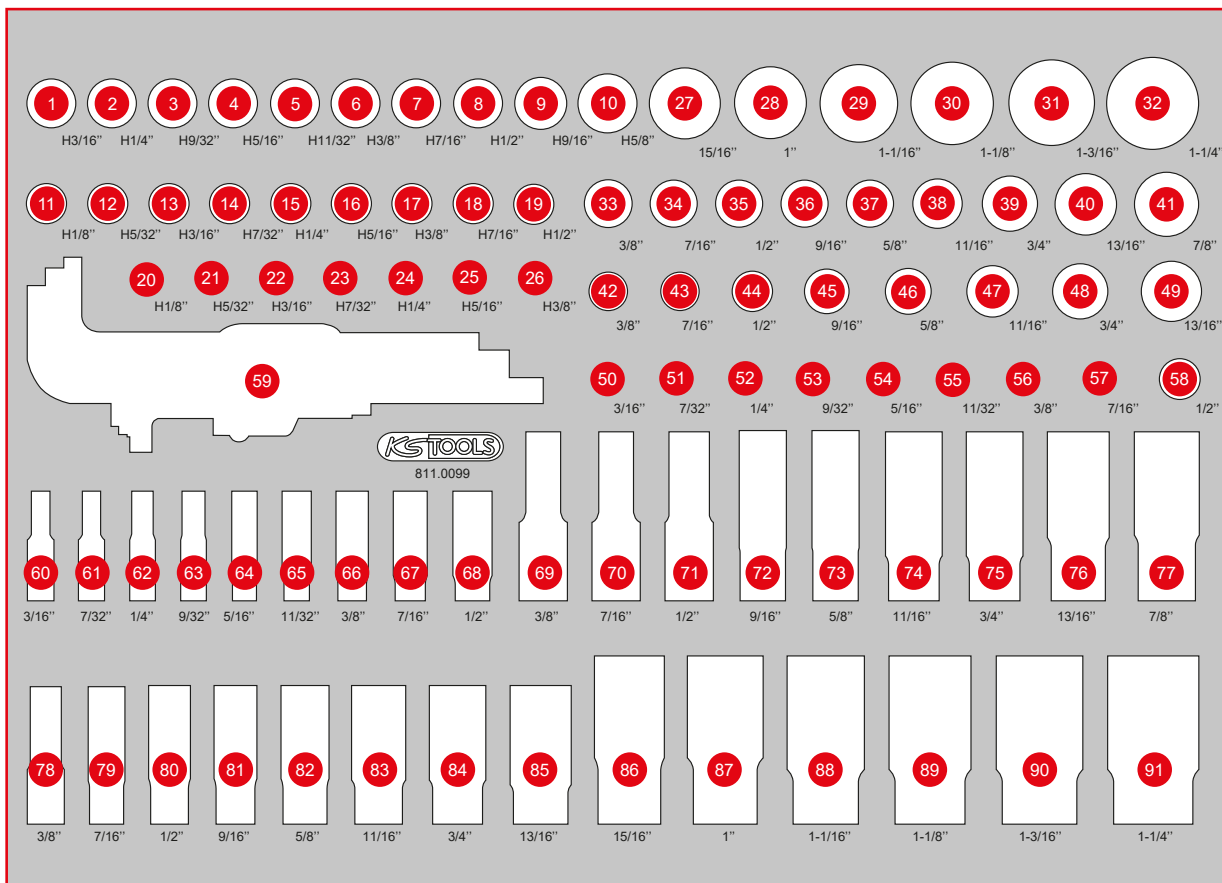

Pos.	Code	Description	pcs	Pos.	Code	Description	pcs	Pos.	Code	Description	pcs
46	911.4003	3/8" 12 Point socket, 5/8"	1	61	917.1566	1/4" 12 Point socket deep 7/32"	1	77	917.1283	1/2" 12 Point socket, deep, 7/8"	1
47	911.4004	3/8" 12 Point socket, 11/16"	1	62	917.1567	1/4" 12 Point socket deep 1/4"	1	78	917.3983	3/8" 12 Point socket, deep, 3/8"	1
48	911.4005	3/8" 12 Point socket, 3/4"	1	63	917.1568	1/4" 12 Point socket deep 9/32"	1	79	917.3984	3/8" 12 Point socket, deep, 7/16"	1
49	917.3854	3/8" 12 Point socket, 13/16"	1	64	917.1569	1/4" 12 Point socket deep 5/16"	1	80	917.3985	3/8" 12 Point socket, deep, 1/2"	1
50	917.1474	1/4" 12 Point socket, 3/16"	1	65	917.1570	1/4" 12 Point socket deep 11/32"	1	81	917.3986	3/8" 12 Point socket, deep, 9/16"	1
51	917.1475	1/4" 12 Point socket, 7/32"	1	66	917.1571	1/4" 12 Point socket deep 3/8"	1	82	917.3987	3/8" 12 Point socket, deep, 5/8"	1
52	917.1476	1/4" 12 Point socket, 1/4"	1	67	917.1572	1/4" 12 Point socket deep 7/16"	1	83	917.3988	3/8" 12 Point socket, deep, 11/16"	1
53	917.1477	1/4" 12 Point socket, 9/32"	1	68	917.1573	1/4" 12 Point socket deep 1/2"	1	84	917.3989	3/8" 12 Point socket, deep, 3/4"	1
54	917.1478	1/4" 12 Point socket, 5/16"	1	69	917.1287	1/2" 12 Point socket, deep, 3/8"	1	85	917.3990	3/8" 12 Point socket, deep, 13/16"	1
55	917.1479	1/4" 12 Point socket, 11/32"	1	70	917.1288	1/2" 12 Point socket, deep, 7/16"	1	86	917.1284	1/2" 12 Point socket, deep, 15/16"	1
56	917.1480	1/4" 12 Point socket, 3/8"	1	71	917.1277	1/2" 12 Point socket, deep, 1/2"	1	87	917.1289	1/2" 12 Point socket, deep, 1"	1
57	917.1481	1/4" 12 Point socket, 7/16"	1	72	917.1278	1/2" 12 Point socket, deep, 9/16"	1	88	917.5348	1/2" 12 Point socket, deep, 1.1/16"	1
58	917.1482	1/4" 12 Point socket, 1/2"	1	73	917.1279	1/2" 12 Point socket, deep, 5/8"	1	89	917.5349	1/2" 12 Point socket, deep, 1.1/8"	1
59	151.4520	Ball ended hexagon key wrench set, extra long, 9 pcs, imperial	9	74	917.1280	1/2" 12 Point socket, deep, 11/16"	1	90	917.5353	1/2" 12 Point socket, deep, 1.3/16"	1
60	917.1565	1/4" 12 Point socket deep 3/16"	1	75	917.1281	1/2" 12 Point socket, deep, 3/4"	1	91	917.5351	1/2" 12 Point socket, deep, 1.1/4"	1
				76	917.1282	1/2" 12 Point socket, deep, 13/16"	1				

811.1040

# M Screw spanner set

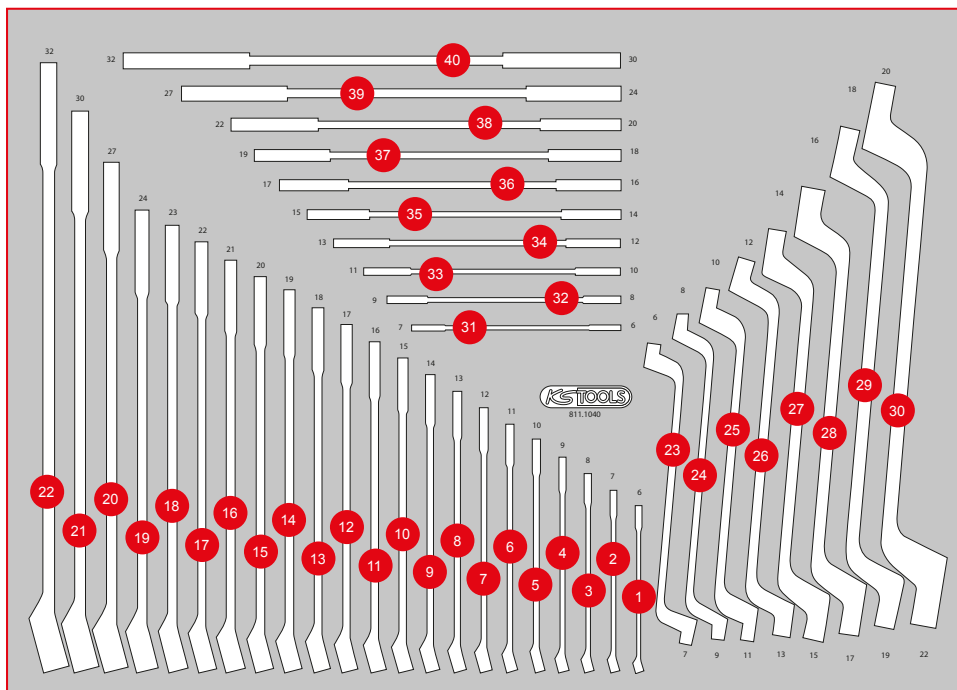
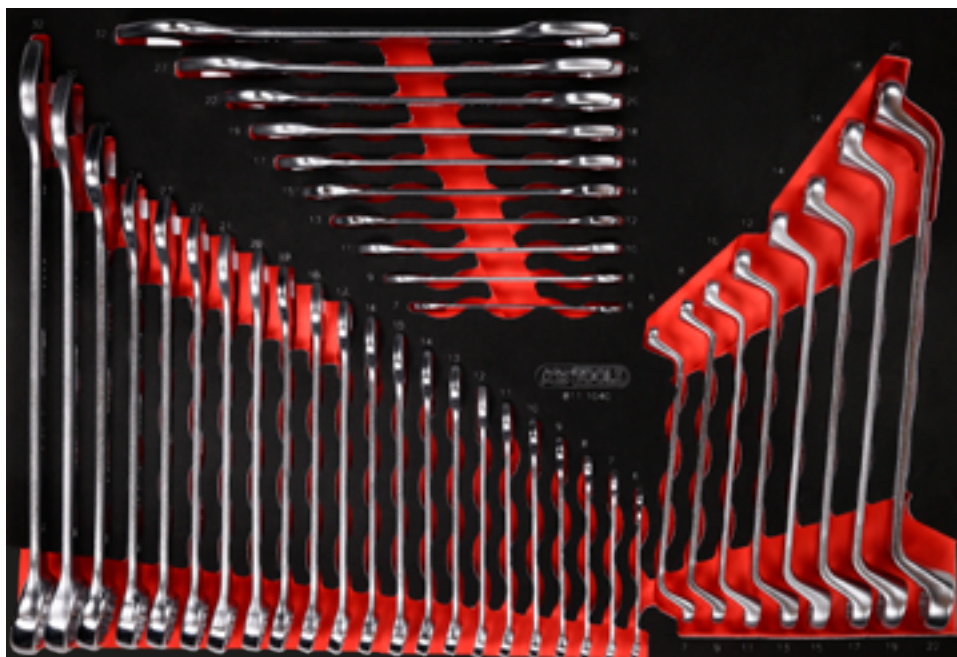

Pos.	Code	Description	pcs
1	517.0606	Combination spanners, offset, 6 mm	1
2	517.0607	Combination spanners, offset, 7 mm	1
3	517.0608	Combination spanners, offset, 8 mm	1
4	517.0609	Combination spanners, offset, 9 mm	1
5	517.0610	Combination spanners, offset, 10 mm	1
6	517.0611	Combination spanners, offset, 11 mm	1
7	517.0612	Combination spanners, offset, 12 mm	1
8	517.0613	Combination spanners, offset, 13 mm	1
9	517.0614	Combination spanners, offset, 14 mm	1
10	517.0615	Combination spanners, offset, 15 mm	1
11	517.0616	Combination spanners, offset, 16 mm	1
12	517.0617	Combination spanners, offset, 17 mm	1
13	517.0618	Combination spanners, offset, 18 mm	1
14	517.0619	Combination spanners, offset, 19 mm	1
15	517.0620	Combination spanners, offset, 20 mm	1
16	517.0621	Combination spanners, offset, 21 mm	1
17	517.0622	Combination spanners, offset, 22 mm	1
18	517.0623	Combination spanners, offset, 23 mm	1
19	517.0624	Combination spanners, offset, 24 mm	1
20	517.0627	Combination spanners, offset, 27 mm	1
21	517.0630	Combination spanners, offset, 30 mm	1
22	517.0632	Combination spanners, offset, 32 mm	1
23	517.0701	Double open ended spanners, 6 x 7 mm	1
24	517.0702	Double open ended spanners, 8 x 9 mm	1
25	517.0704	Double open ended spanners, 10 x 11 mm	1
26	517.0707	Double open ended spanners, 12 x 13 mm	1
27	517.0709	Double open ended spanners, 14 x 15 mm	1
28	517.0710	Double open ended spanners, 16 x 17 mm	1
29	517.0712	Double open ended spanners, 18 x 19 mm	1
30	517.0714	Double open ended spanners, 20 x 22 mm	1
31	517.0716	Double open ended spanners, 24 x 27 mm	1
32	517.0718	Double open ended spanners, 30 x 32 mm	1
33	517.0801	Double ring spanner, offset, 6 x 7 mm	1
34	517.0802	Double ring spanner, offset, 8 x 9 mm	1
35	517.0804	Double ring spanner, offset, 10 x 11 mm	1
36	517.0807	Double ring spanner, offset, 12 x 13 mm	1
37	517.0809	Double ring spanner, offset, 14 x 15 mm	1
38	517.0810	Double ring spanner, offset, 16 x 17 mm	1
39	517.0812	Double ring spanner, offset, 18 x 19 mm	1
40	517.0813	Double ring spanner, offset, 20 x 22 mm	1

811.0031

**M** Screw spanner set



568 x 398



P10



P10TC



P15



P20



P30



P35



P45



Pos.	Code	Description	pcs
1	517.0895	Double ring spanner, offset, 15/16 x 1"	1
2	517.0894	Double ring spanner, offset, 13/16 x 7/8"	1
3	517.0889	Double ring spanner, offset, 11/16 x 3/4"	1
4	517.0887	Double ring spanner, offset, 9/16 x 5/8"	1
5	517.0885	Double ring spanner, offset, 1/2 x 9/16"	1
6	517.0883	Double ring spanner, offset, 3/8 x 7/16"	1
7	517.0881	Double ring spanner, offset, 1/4 x 5/16"	1
8	517.9268	CLASSIC flare nut spanner, 5/8" x 11/16"	1
9	517.9267	CLASSIC flare nut spanner, 1/2" x 9/16"	1
10	517.9266	CLASSIC flare nut spanner, 3/8" x 7/16"	1
11	517.9265	CLASSIC flare nut spanner, 1/4" x 5/16"	1
12	517.0781	Double open ended spanners, 1/4 x 5/16"	1
13	517.0783	Double open ended spanners, 3/8 x 7/16"	1
14	517.0785	Double open ended spanners, 1/2 x 9/16"	1
15	517.0788	Double open ended spanners, 5/8 x 11/16"	1
16	517.0789	Double open ended spanners, 11/16 x 3/4"	1
17	517.0794	Double open ended spanners, 13/16 x 7/8"	1
18	517.0795	Double open ended spanners, 15/16 x 1"	1
19	517.0774	Double open ended spanners, 1.1/8" x 1.1/4"	1
20	517.1901	Combination spanners, offset, 1/4"	1
21	517.1902	Combination spanners, offset, 5/16"	1
22	517.1903	Combination spanners, offset, 3/8"	1
23	517.1904	Combination spanners, offset, 7/16"	1
24	517.1951	Combination spanners, offset, 1/2"	1
25	517.1906	Combination spanners, offset, 9/16"	1
26	517.1907	Combination spanners, offset, 5/8"	1
27	517.1908	Combination spanners, offset, 11/16"	1
28	517.1909	Combination spanners, offset, 3/4"	1
29	517.1912	Combination spanners, offset, 13/16"	1
30	517.1913	Combination spanners, offset, 7/8"	1
31	517.1914	Combination spanners, offset, 15/16"	1

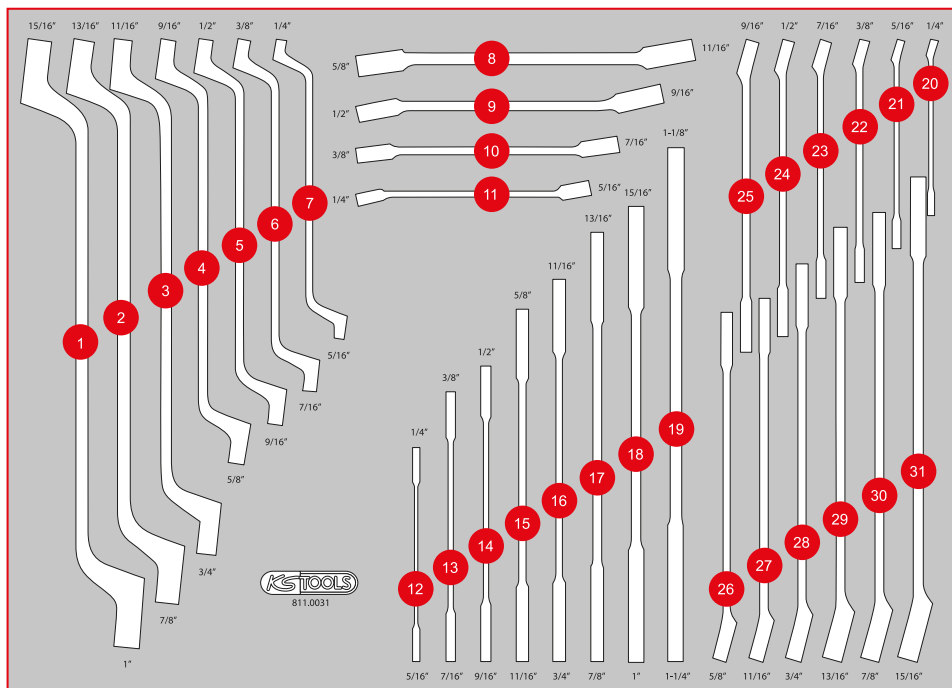

811.0033

**M** Pliers, Hammer and chisel set



Pos.	Code	Description	pcs
1	115.1012	ERGOTORQUE diagonal side cutter, 160 mm	1
2	115.1021	ERGOTORQUE combination pliers, 180 mm	1
3	115.1033	Self grip wrench, 220 mm	1
4	156.0231	Pin punch, Ø 3 mm, cylindrical shaft	1
5	156.0232	Pin punch, Ø 4 mm, cylindrical shaft	1
6	156.0233	Pin punch, Ø 5 mm, cylindrical shaft	1
7	156.0234	Pin punch, Ø 6 mm, cylindrical shaft	1
8	300.0114	Tape measure with locking device and belt clip, black red, 5 m, 19 mm	1
9	115.1019	ERGOTORQUE bent nose pliers serrated, 210 mm	1
10	115.1024	ERGOTORQUE long nose pliers serrated cutter, 200 mm	1
11	156.0237	Punch, Ø 3 mm, conical	1
12	156.0238	Punch, Ø 4 mm, conical	1
13	156.0244	Punch, Ø 5 mm, conical	1
14	156.0254	Flat chisel, octagon, 18 mm	1
15	156.0241	Flat chisel, octagon, 20 mm	1
16	907.2135	Universal snap off blade knife 18 mm	1
17	142.1402	Fitters Hammer, fibreglas handle, 400 g	1
18	142.5101	Club Hammer, fibreglas handle, 1000 g	1
19	115.2010	Water pump pliers, 240 mm	1
20	907.2166	Snap off blades 0,5 x 1,8 x 100 mm, dispenser with 10 pieces	10
21	157.0405	Tri-bastard file, form C, cut 2, 200 mm	1
22	157.0105	Halfround file, form E, cut 2, 20 mm	1
23	157.0205	Round file, form F, cut 2, 200 mm	1
24	157.0005	Flat file, form B, cut 2, 200 mm	1

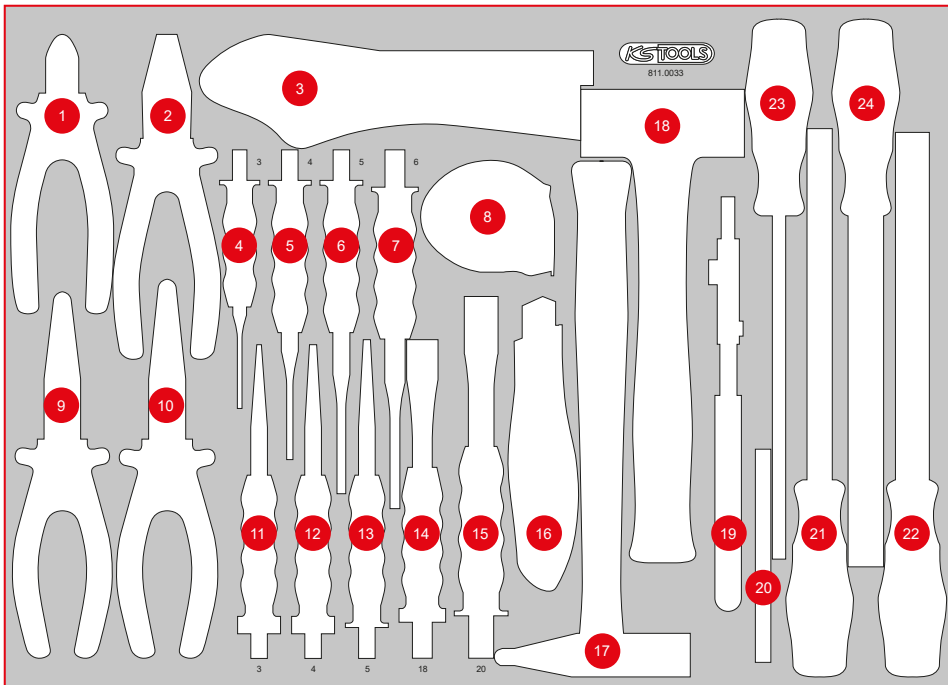

# P15

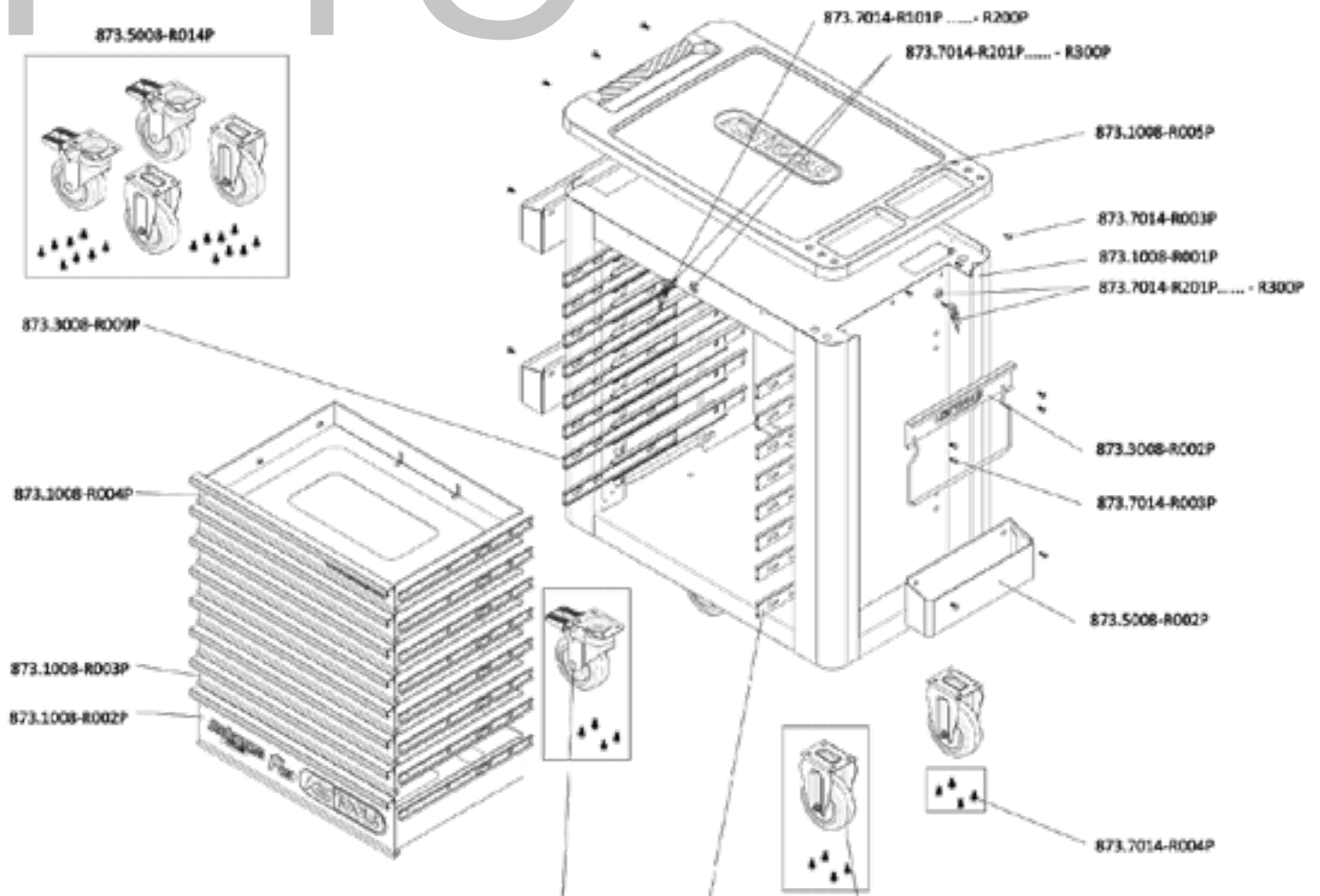

## INDIVIDUAL PARTS LIST

Art.-Nr.	Description	amount
873.7014-R101P...	Replacement key for PERFORMANCEplus workshop trolley lock number xyz	2
873.7014-R201P...	Lock with 2 keys for PERFORMANCEplus workshop trolley lock number xyz	2
873.1008-R001P	Body of workshop trolley	1
873.1008-R002P	Compartment with logo and ball-bearing guide, 568x398x145 mm	1
873.1008-R003P	Compartment with ball-bearing guide, for workshop trolley P10/P10TC/P15, 568x398x65 mm	6
873.1008-R004P	Compartment with website and ball-bearing guide, for workshop trolley P10/P15, 568x398x65 mm	1
873.1008-R005P	Plastic work surface with handle	1
873.3008-R002P	Paper roll holder for PERFORMANCEplus workshop trolley P10/P15/P25	1
873.3008-R008P	Full extension (with ball-bearing guide) with automatic retraction	8
873.3008-R009P	Full extension (with ball-bearing guide) with automatic retraction	8
873.5008-R002P	Can holder for PERFORMANCEplus workshop trolley P10/P15/P25/P35	3
873.5008-R009P	Fixed castors for PERFORMANCEplus workshop trolley, incl. screws	2
873.5008-R011P	Swivel castors with brakes, for PERFORMANCEplus workshop trolley, incl. screws	2
873.5008-R014P	Roller set for PERFORMANCEplus workshop trolley, incl. screws	1
873.7014-R003P	M6x12 screw (1 pcs.) for PERFORMANCEplus workshop trolley accessories	16
873.7014-R004P	M8 screws for PERFORMANCEplus workshop trolley rollers (16 pcs.)	1



**873.7014-R101P...R200P**  
Replacement key for lock number xyz



**873.7014-R201P...R300P**  
Lock with 2 keys, lock number xyz



**873.3008-R008P**  
Full extension (with ball-bearing guide) with automatic retraction, right



**873.3008-R009P**  
Full extension (with ball-bearing guide) with automatic retraction, left



**873.5008-R009P**  
Fixed castors, incl. screws

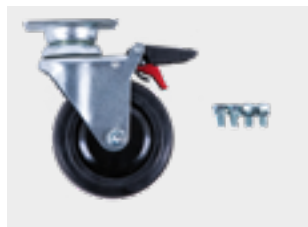

**873.5008-R011P**  
Swivel castors with brakes, incl. screws



**873.5008-R014P**  
Roller set, incl. screws



**873.1008-R005P**  
Plastic work surface with handle



**873.1008-R004P**  
Compartment with website and ball-bearing guide, 568x398x65 mm



**873.1008-R003P**  
Compartment with ball-bearing guide, 568x398x65 mm



**873.1008-R002P**  
Compartment with logo and ball-bearing guide, 568x398x145 mm



**873.5008-R002P**  
Can holder including screws, W = 310 mm



**873.3008-R002P**  
Paper roll holder including screws, W= 320 mm



**873.7014-R004P**  
M8 screws (16 pcs.)



**873.7014-R003P**  
M6x12 screw (1 pcs.)



**873.1008-R001P**  
Body of workshop trolley



The only thing that can't be replaced is the quality!