

P15

workshop tool trolley
with 180 tools for 4 drawers
815.4180

THE COMPACT HEAVYWEIGHT

P15



Workshop trolley P15
with 8 compartments
873.1008

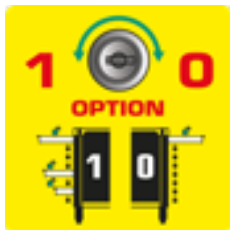

DUO Lock Brilliant locking system



Eight drawers each load capacity up to 50 kg



Stable **ball bearing**



Plastic Surface

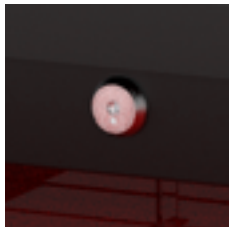

Lock lockable

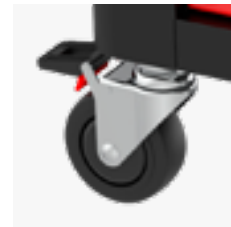

Anti-static castors with brakes



Integrated **corner protection**



Paper roll holder included



Can holder included

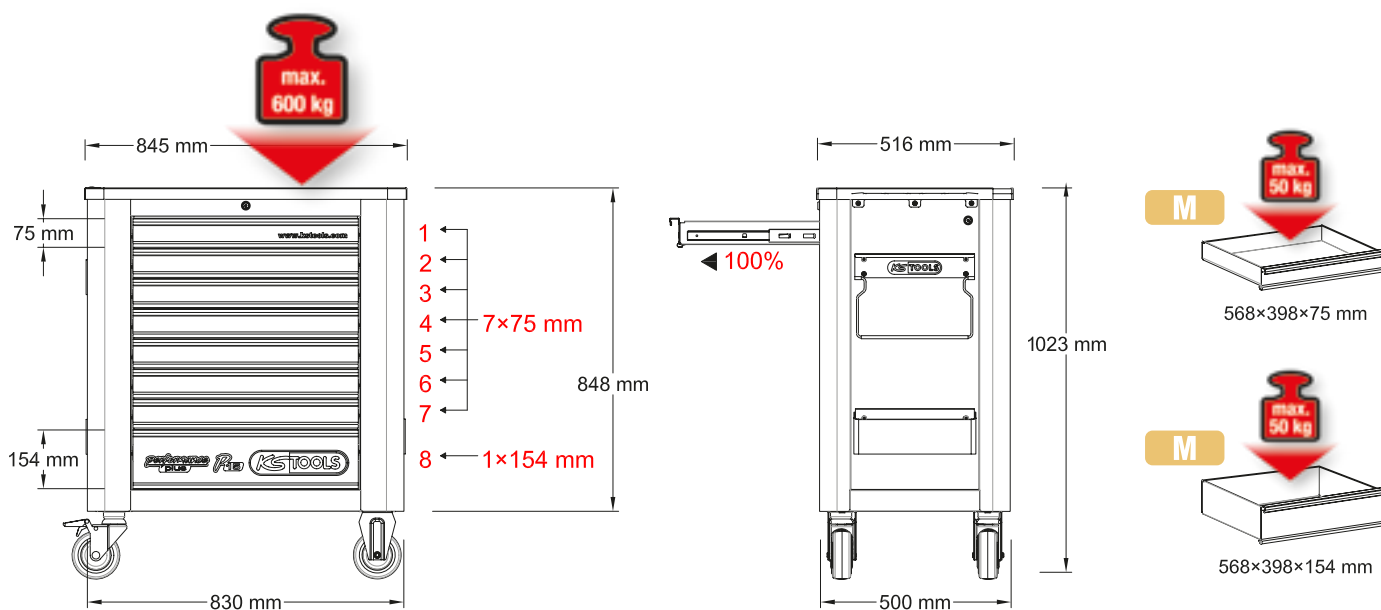

P15 workshop tool trolley set with 180 tools for 4 drawers

815.4180

1 PCS
180
M

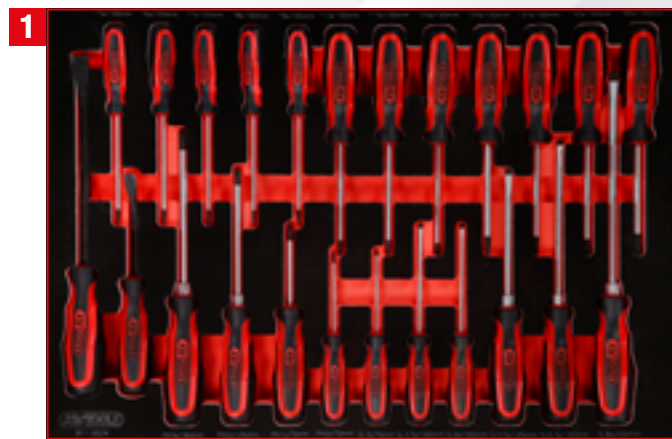

Screwdriver set in foam insert

811.0024

1 PCS
24

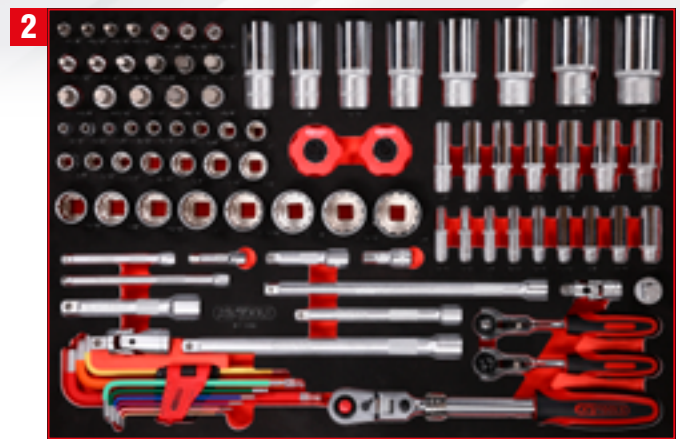

1/4" + 3/8" + 1/2" socket spanner set in foam insert

811.0092

1 PCS
92



Screw spanner set in foam insert

811.0031

1 PCS
31



Pliers, hammer and chisel set in foam insert

811.0033

1 PCS
33

811.0024

M Screwdriver set

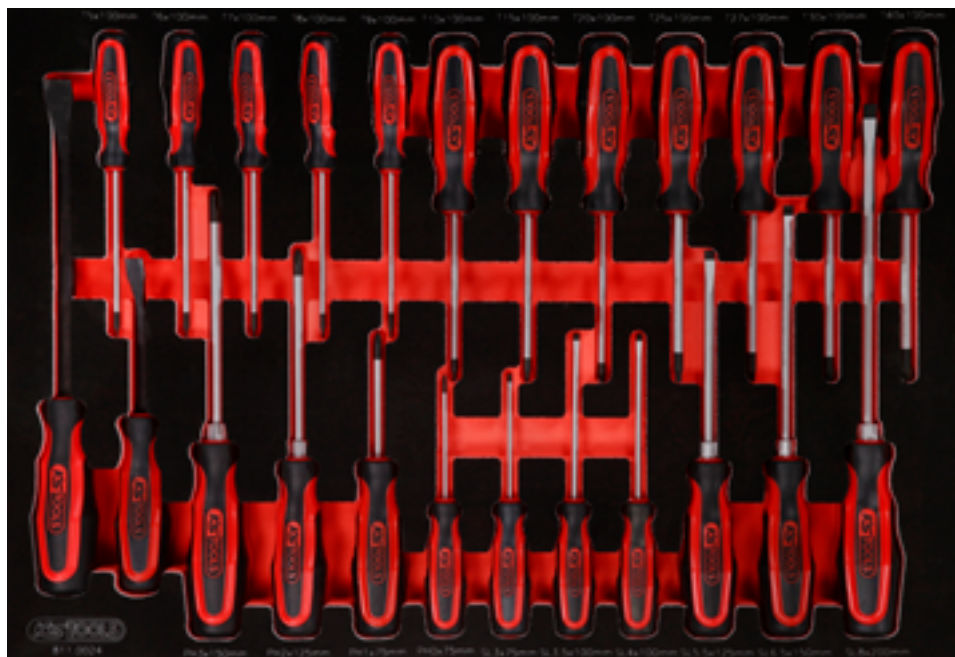

Pos.	Code	Description	pcs
1	911.8102	Pry bar, 15 x 185 mm	1
2	911.8101	Pry bar, 11 x 115 mm	1
3	159.1133	ERGOTORQUEplus screwdriver, Torx, T5	1
4	159.1134	ERGOTORQUEplus screwdriver, Torx, T6	1
5	159.1135	ERGOTORQUEplus screwdriver, Torx, T7	1
6	159.1030	ERGOTORQUEplus screwdriver, Torx, T8	1
7	159.1031	ERGOTORQUEplus screwdriver, Torx, T9	1
8	159.1032	ERGOTORQUEplus screwdriver, Torx, T10	1
9	159.1033	ERGOTORQUEplus screwdriver, Torx, T15	1
10	159.1034	ERGOTORQUEplus screwdriver, Torx, T20	1
11	159.1035	ERGOTORQUEplus screwdriver, Torx, T25	1
12	159.1036	ERGOTORQUEplus screwdriver, Torx, T27	1
13	159.1037	ERGOTORQUEplus screwdriver, Torx, T30	1
14	159.1038	ERGOTORQUEplus screwdriver, Torx, T40	1
15	159.1024	ERGOTORQUEplus screwdriver, Torx, PH3, 265 mm	1
16	159.1022	ERGOTORQUEplus screwdriver, Torx, PH2, 230 mm	1
17	159.1020	ERGOTORQUEplus screwdriver, Torx, PH1, 180 mm	1
18	159.1027	ERGOTORQUEplus screwdriver, Torx, PH0, 155 mm	1
19	159.1002	ERGOTORQUEplus screwdriver for slotted screws, 3 mm, 155 mm	1
20	159.1112	ERGOTORQUEplus screwdriver for slotted screws, 3,5 mm, 180 mm	1
21	159.1004	ERGOTORQUEplus screwdriver for slotted screws, 4 mm, 180 mm	1
22	159.1006	ERGOTORQUEplus screwdriver for slotted screws, 5,5 mm, 230 mm	1
23	159.1009	ERGOTORQUEplus screwdriver for slotted screws, 6,5 mm, 255 mm	1
24	159.1011	ERGOTORQUEplus screwdriver for slotted screws, 8 mm, 315 mm	1

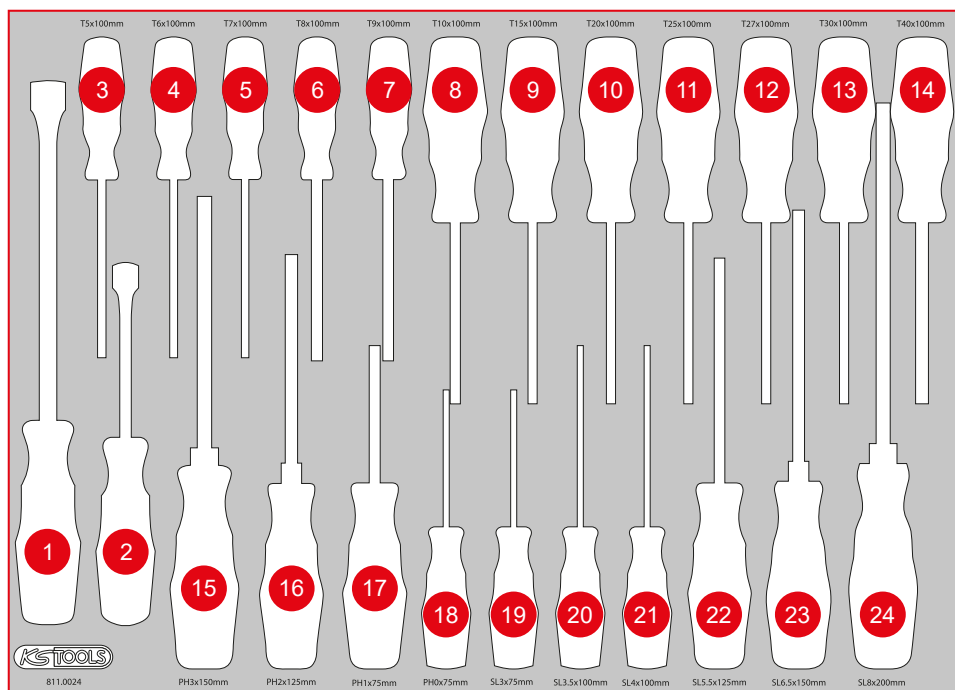

811.0092

M 1/4" + 3/8" + 1/2" Socket spanner set



Pos.	Code	Description	pcs	Pos.	Code	Description	pcs	Pos.	Code	Description	pcs
1	914.1220	1/2" SlimPOWER Telescopic reversible ratchet, 72 teeth	1	13	911.1202	1/2" Extensions, 125 mm	1	28	911.4000	3/8" 12 Point socket, 1/2"	1
2	914.3815	3/8" MODIFIX mini T-handle swivel head ratchet, 72 teeth, 0° + 90°	1	14	911.1203	1/2" Extensions, 250 mm	1	29	911.4001	3/8" 12 Point socket, 9/16"	1
3	914.1405	1/4" MODIFIX mini T-handle swivel head ratchet, 72 teeth	1	15	911.3850	3/8" Universal joint	1	30	911.4003	3/8" 12 Point socket, 5/8"	1
4	151.4520	KBall ended hexagon key wrench set, extra long, 9 pcs, imperial	9	16	911.3826	3/8" Sliding / reducing adaptor, 1/2"F x 3/8"M	1	31	911.4004	3/8" 12 Point socket, 11/16"	1
5	911.1250	1/2" Universal joint	1	17	917.1474	1/4" 12 Point socket, 3/16"	1	32	911.4005	3/8" 12 Point socket, 3/4"	1
6	911.1423	1/4" Extension with hexagon drive, 50 mm	1	18	917.1475	1/4" 12 Point socket, 7/32"	1	33	917.1380	1/2" 12 Point socket, 13/16"	1
7	911.1424	1/4" Extension with hexagon drive, 100 mm	1	19	917.1476	1/4" 12 Point socket, 1/4"	1	34	917.1381	1/2" 12 Point socket, 7/8"	1
8	911.1451	1/4" Extension with hexagon drive, 150 mm	1	20	917.1477	1/4" 12 Point socket, 9/32"	1	35	917.1382	1/2" 12 Point socket, 15/16"	1
9	911.3852	3/8" Extension with knurling, 45 mm	1	21	917.1478	1/4" 12 Point socket, 5/16"	1	36	917.1383	1/2" 12 Point socket, 1"	1
10	911.3801	3/8" Extension with knurling, 75 mm	1	22	917.1479	1/4" 12 Point socket, 11/32"	1	37	917.1384	1/2" 12 Point socket, 1.1/16"	1
11	911.3802	3/8" Extension with knurling, 150 mm	1	23	917.1480	1/4" 12 Point socket, 3/8"	1	38	917.1385	1/2" 12 Point socket, 1.1/8"	1
12	911.3803	3/8" Extension with knurling, 250 mm	1	24	917.1481	1/4" 12 Point socket, 7/16"	1	39	917.1386	1/2" 12 Point socket, 1.3/16"	1
				25	917.1482	1/4" 12 Point socket, 1/2"	1	40	917.1387	1/2" 12 Point socket, 1.1/4"	1
				26	917.3851	3/8" 12 Point socket, 3/8"	1	41	917.1565	1/4" 12 Point socket deep 3/16"	1
				27	917.3852	3/8" 12 Point socket, 7/16"	1	42	917.1566	1/4" 12 Point socket deep 7/32"	1

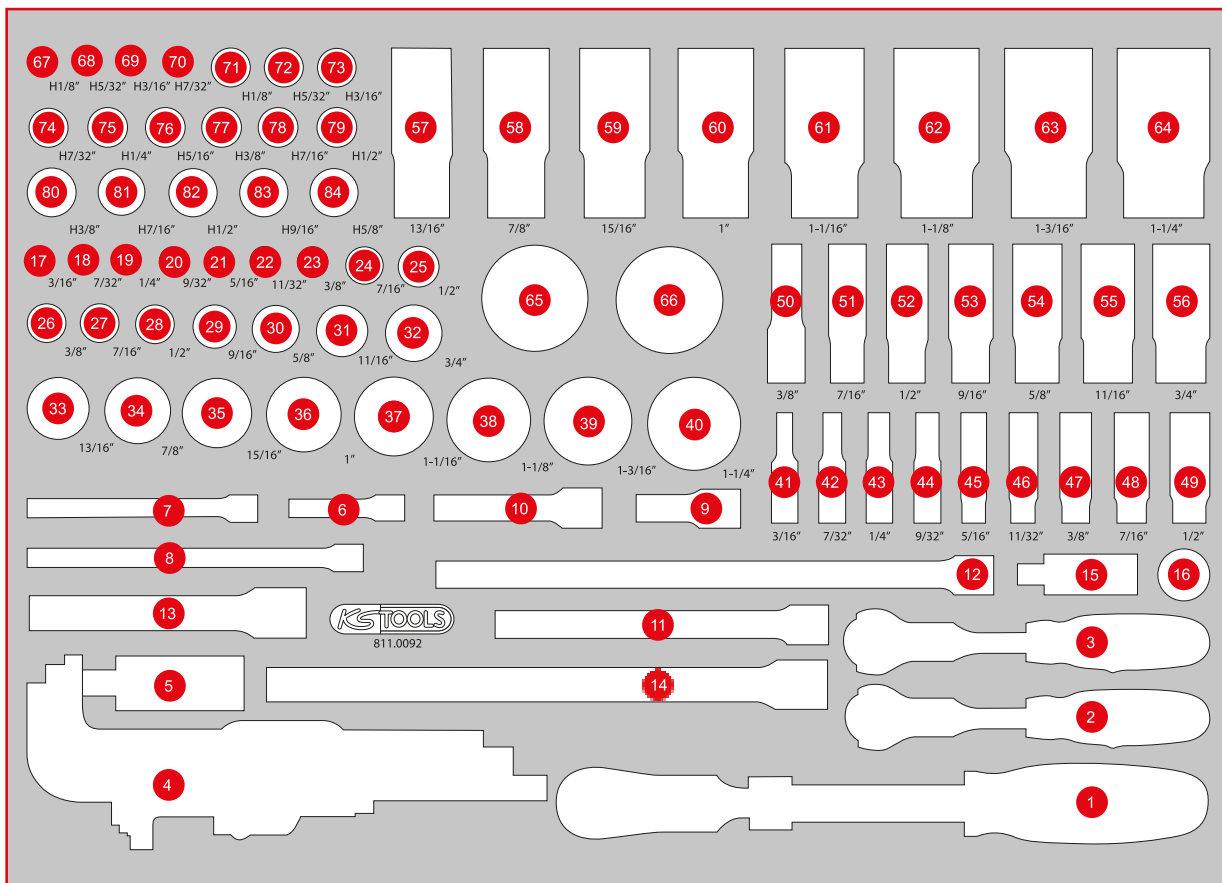

Pos.	Code	Description	pcs	Pos.	Code	Description	pcs	Pos.	Code	Description	pcs
43	917.1567	1/4" 12 Point socket deep 1/4"	1	58	917.1283	1/2" 12 Point socket, deep, 7/8"	1	73	917.3963	3/8" Bit socket hexagon, 3/16"	1
44	917.1568	1/4" 12 Point socket deep 9/32"	1	59	917.1284	1/2" 12 Point socket, deep, 15/16"	1	74	917.3968	3/8" Bit socket hexagon, 7/32"	1
45	917.1569	1/4" 12 Point socket deep 5/16"	1	60	917.1289	1/2" 12 Point socket, deep, 1"	1	75	917.3964	3/8" Bit socket hexagon, 1/4"	1
46	917.1570	1/4" 12 Point socket deep 11/32"	1	61	917.5348	1/2" 12 Point socket, deep, 1.1/16"	1	76	917.3965	3/8" Bit socket hexagon, 5/16"	1
47	917.1571	1/4" 12 Point socket deep 3/8"	1	62	917.5349	1/2" 12 Point socket, deep, 1.1/8"	1	77	917.3966	3/8" Bit socket hexagon, 3/8"	1
48	917.1572	1/4" 12 Point socket deep 7/16"	1	63	917.5353	1/2" 12 Point socket, deep, 1.3/16"	1	78	917.3993	3/8" Bit socket hexagon, 7/16"	1
49	917.1573	1/4" 12 Point socket deep 1/2"	1	64	917.5351	1/2" 12 Point socket, deep, 1.1/4"	1	79	917.3994	3/8" Bit socket hexagon, 1/2"	1
50	917.3983	3/8" 12 Point socket, deep, 3/8"	1	65	914.3810	Mini hand reversible ratchet, 3/8", 72 teeth	1	80	917.1321	1/2" Bit socket hexagon, short, 3/8"	1
51	917.3984	3/8" 12 Point socket, deep, 7/16"	1	66	914.1410	Mini hand reversible ratchet, 1/4", 72 teeth	1	81	911.5387	1/2" Bit socket hexagon, short, 7/16"	1
52	917.3985	3/8" 12 Point socket, deep, 1/2"	1	67	917.1440	1/4" Bit socket hexagon, 1/8"	1	82	917.1322	1/2" Bit socket hexagon, short, 1/2"	1
53	917.3986	3/8" 12 Point socket, deep, 9/16"	1	68	917.1441	1/4" Bit socket hexagon, 5/32"	1	83	917.1323	1/2" Bit socket hexagon, short, 9/16"	1
54	917.3987	3/8" 12 Point socket, deep, 5/8"	1	69	917.1442	1/4" Bit socket hexagon, 3/16"	1	84	917.1324	1/2" Bit socket hexagon, short, 5/8"	1
55	917.3988	3/8" 12 Point socket, deep, 11/16"	1	70	917.1443	1/4" Bit socket hexagon, 7/32"	1				
56	917.3989	3/8" 12 Point socket, deep, 3/4"	1	71	917.3967	3/8" Bit socket hexagon, 1/8"	1				
57	917.1282	1/2" 12 Point socket, deep, 13/16"	1	72	917.3962	3/8" Bit socket hexagon, 5/32"	1				

M Screw spanner set



Pos.	Code	Description	pcs
1	517.0895	Double ring spanner, offset, 15/16 x 1"	1
2	517.0894	Double ring spanner, offset, 13/16 x 7/8"	1
3	517.0889	Double ring spanner, offset, 11/16 x 3/4"	1
4	517.0887	Double ring spanner, offset, 9/16 x 5/8"	1
5	517.0885	Double ring spanner, offset, 1/2 x 9/16"	1
6	517.0883	Double ring spanner, offset, 3/8 x 7/16"	1
7	517.0881	Double ring spanner, offset, 1/4 x 5/16"	1
8	517.9268	CLASSIC flare nut spanner, 5/8" x 11/16"	1
9	517.9267	CLASSIC flare nut spanner, 1/2" x 9/16"	1
10	517.9266	CLASSIC flare nut spanner, 3/8" x 7/16"	1
11	517.9265	CLASSIC flare nut spanner, 1/4" x 5/16"	1
12	517.0781	Double open ended spanners, 1/4 x 5/16"	1
13	517.0783	Double open ended spanners, 3/8 x 7/16"	1
14	517.0785	Double open ended spanners, 1/2 x 9/16"	1
15	517.0788	Double open ended spanners, 5/8 x 11/16"	1
16	517.0789	Double open ended spanners, 11/16 x 3/4"	1
17	517.0794	Double open ended spanners, 13/16 x 7/8"	1
18	517.0795	Double open ended spanners, 15/16 x 1"	1
19	517.0774	Double open ended spanners, 1.1/8" x 1.1/4"	1
20	517.1901	Combination spanners, offset, 1/4"	1
21	517.1902	Combination spanners, offset, 5/16"	1
22	517.1903	Combination spanners, offset, 3/8"	1
23	517.1904	Combination spanners, offset, 7/16"	1
24	517.1951	Combination spanners, offset, 1/2"	1
25	517.1906	Combination spanners, offset, 9/16"	1
26	517.1907	Combination spanners, offset, 5/8"	1
27	517.1908	Combination spanners, offset, 11/16"	1
28	517.1909	Combination spanners, offset, 3/4"	1
29	517.1912	Combination spanners, offset, 13/16"	1
30	517.1913	Combination spanners, offset, 7/8"	1
31	517.1914	Combination spanners, offset, 15/16"	1

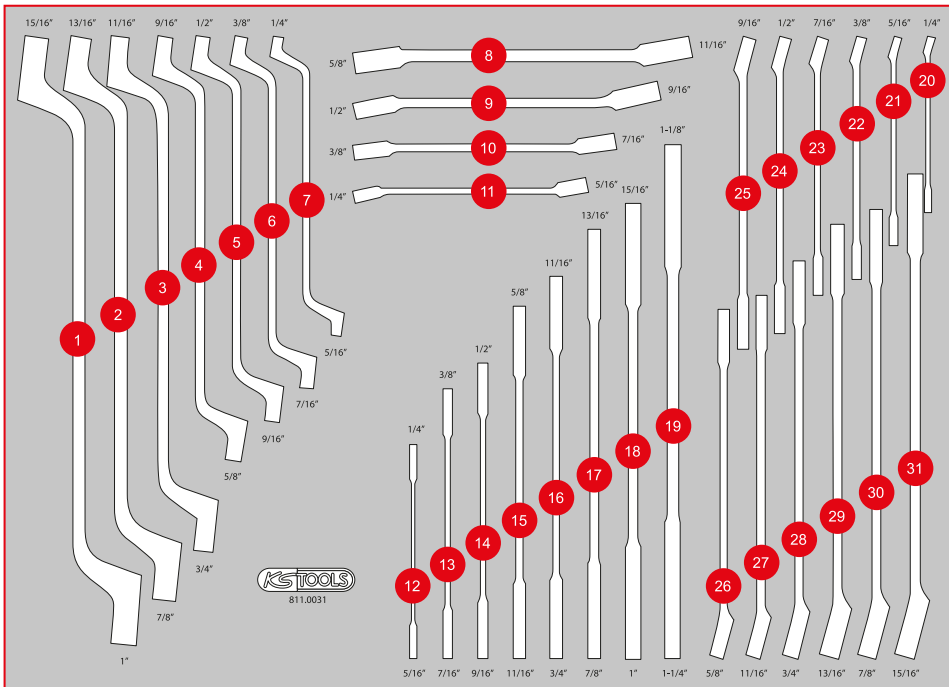

811.0033

M Pliers, Hammer and chisel set

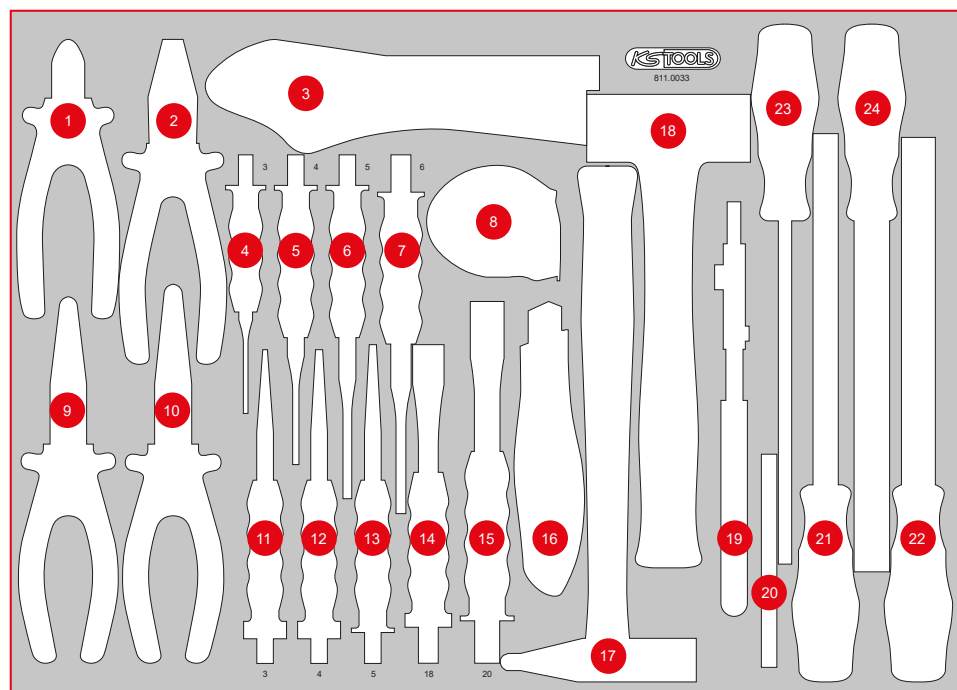

Pos.	Code	Description	pcs
1	115.1012	ERGOTORQUE diagonal side cutter, 160 mm	1
2	115.1021	ERGOTORQUE combination pliers, 180 mm	1
3	115.1033	Self grip wrench, 220 mm	1
4	156.0231	Pin punch, Ø 3 mm, cylindrical shaft	1
5	156.0232	Pin punch, Ø 4 mm, cylindrical shaft	1
6	156.0233	Pin punch, Ø 5 mm, cylindrical shaft	1
7	156.0234	Pin punch, Ø 6 mm, cylindrical shaft	1
8	300.0114	Tape measure with locking device and belt clip, black red, 5 m, 19 mm	1
9	115.1019	ERGOTORQUE bent nose pliers serrated, 210 mm	1
10	115.1024	ERGOTORQUE long nose pliers serrated cutter, 200 mm	1
11	156.0237	Punch, Ø 3 mm, conical	1
12	156.0238	Punch, Ø 4 mm, conical	1
13	156.0244	Punch, Ø 5 mm, conical	1
14	156.0254	Flat chisel, octagon, 18 mm	1
15	156.0241	Flat chisel, octagon, 20 mm	1
16	907.2135	Universal snap off blade knife 18 mm	1
17	142.1402	Fitters Hammer, fibreglas handle, 400 g	1
18	142.5101	Club Hammer, fibreglas handle, 1000 g	1
19	115.2010	Water pump pliers, 240 mm	1
20	907.2166	Snap off blades 0,5 x 1 8 x 100 mm, dispenser with 10 pieces	10
21	157.0405	Tri-bastard file, form C, cut 2, 200 mm	1
22	157.0105	Halfround file, form E, cut 2, 20 mm	1
23	157.0205	Round file, form F, cut 2, 200 mm	1
24	157.0005	Flat file, form B, cut 2, 200 mm	1

P15

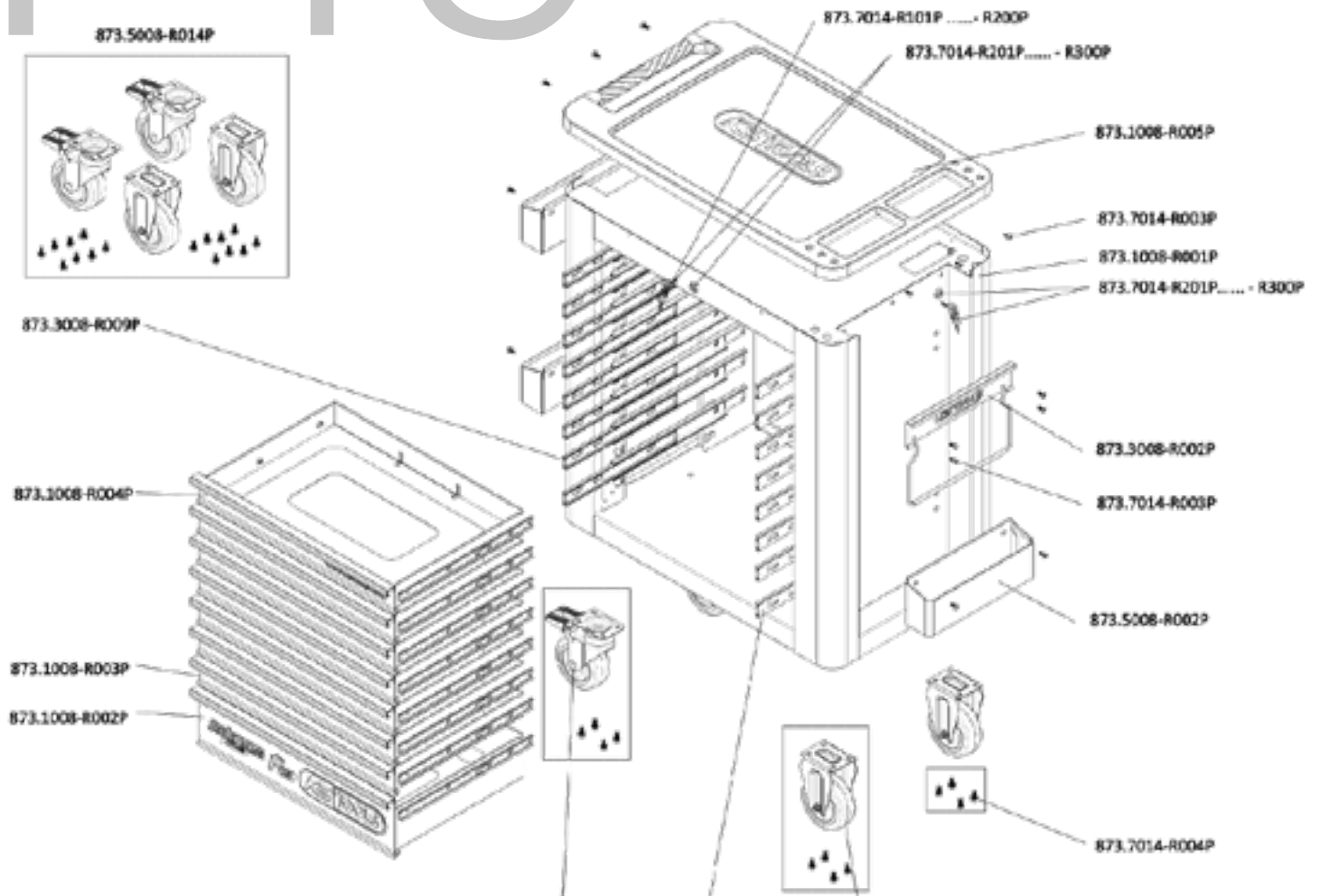

INDIVIDUAL PARTS LIST

Art.-Nr.	Description	amount
873.7014-R101P...	Replacement key for PERFORMANCEplus workshop trolley lock number xyz	2
873.7014-R201P...	Lock with 2 keys for PERFORMANCEplus workshop trolley lock number xyz	2
873.1008-R001P	Body of workshop trolley	1
873.1008-R002P	Compartment with logo and ball-bearing guide, 568x398x145 mm	1
873.1008-R003P	Compartment with ball-bearing guide, for workshop trolley P10/P10TC/P15, 568x398x65 mm	6
873.1008-R004P	Compartment with website and ball-bearing guide, for workshop trolley P10/P15, 568x398x65 mm	1
873.1008-R005P	Plastic work surface with handle	1
873.3008-R002P	Paper roll holder for PERFORMANCEplus workshop trolley P10/P15/P25	1
873.3008-R008P	Full extension (with ball-bearing guide) with automatic retraction	8
873.3008-R009P	Full extension (with ball-bearing guide) with automatic retraction	8
873.5008-R002P	Can holder for PERFORMANCEplus workshop trolley P10/P15/P25/P35	3
873.5008-R009P	Fixed castors for PERFORMANCEplus workshop trolley, incl. screws	2
873.5008-R011P	Swivel castors with brakes, for PERFORMANCEplus workshop trolley, incl. screws	2
873.5008-R014P	Roller set for PERFORMANCEplus workshop trolley, incl. screws	1
873.7014-R003P	M6x12 screw (1 pcs.) for PERFORMANCEplus workshop trolley accessories	16
873.7014-R004P	M8 screws for PERFORMANCEplus workshop trolley rollers (16 pcs.)	1



873.7014-R101P...R200P
Replacement key for lock number xyz



873.7014-R201P...R300P
Lock with 2 keys, lock number xyz



873.3008-R008P
Full extension (with ball-bearing guide) with automatic retraction, right



873.3008-R009P
Full extension (with ball-bearing guide) with automatic retraction, left



873.5008-R009P
Fixed castors, incl. screws



873.5008-R011P
Swivel castors with brakes, incl. screws



873.5008-R014P
Roller set, incl. screws



873.1008-R005P
Plastic work surface with handle



873.1008-R004P
Compartment with website and ball-bearing guide, 568x398x65 mm



873.1008-R003P
Compartment with ball-bearing guide, 568x398x65 mm



873.1008-R002P
Compartment with logo and ball-bearing guide, 568x398x145 mm



873.5008-R002P
Can holder including screws, W = 310 mm



873.3008-R002P
Paper roll holder including screws, W= 320 mm



873.7014-R004P
M8 screws (16 pcs.)



873.7014-R003P
M6x12 screw (1 pcs.)



873.1008-R001P
Body of workshop trolley



The only thing that can't be replaced is the quality!