

P10

workshop tool trolley
with 284 tools for 6 drawers
810.6284

Workshop trolley P10

with 8 compartments

873.0008

THE ENTRY MODEL TO SATISFY HIGH STANDARDS



P10

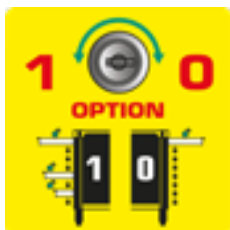

DUO Lock Brilliant locking system



Eight drawers each load capacity up to 50 kg



Stable **ball bearing**



Stainless steel surface

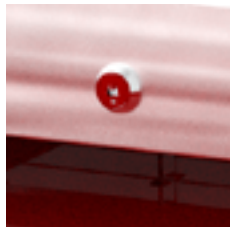

Lock lockable



Anti-static castors with brakes



Integrated **corner protection**



Paper roll holder included



Can holder included

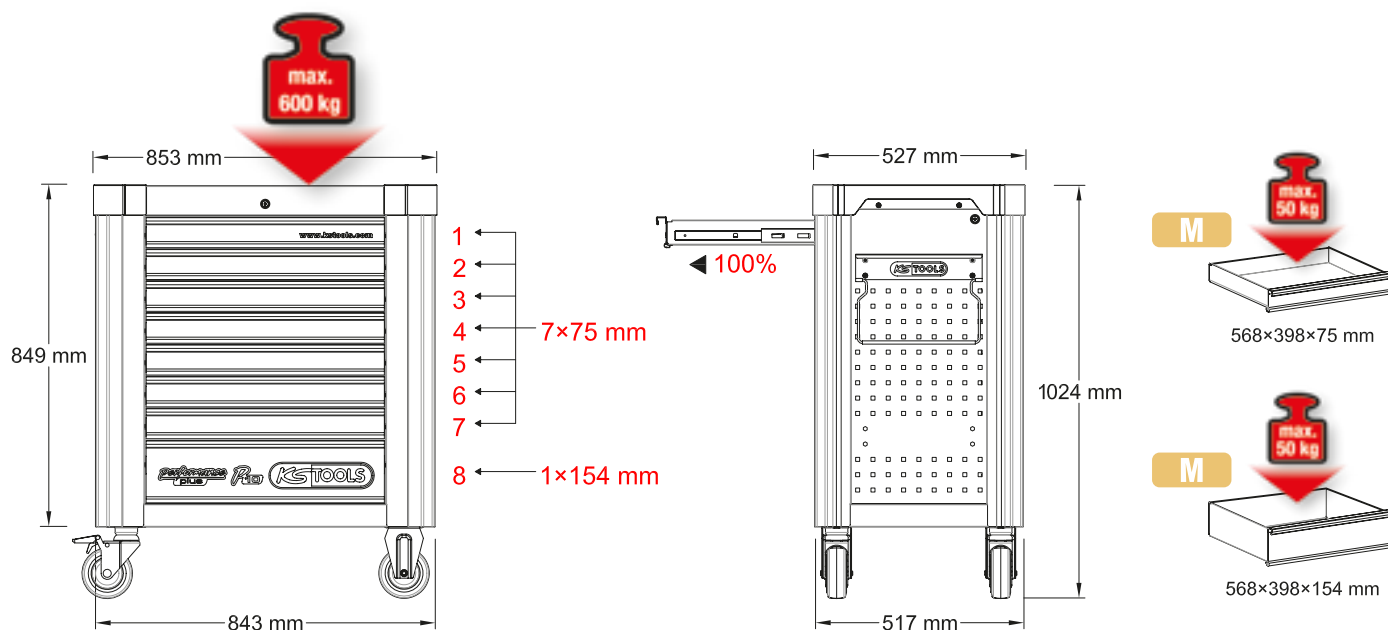

P10 workshop tool trolley set with 284 tools for 6 drawers

810.6284



M

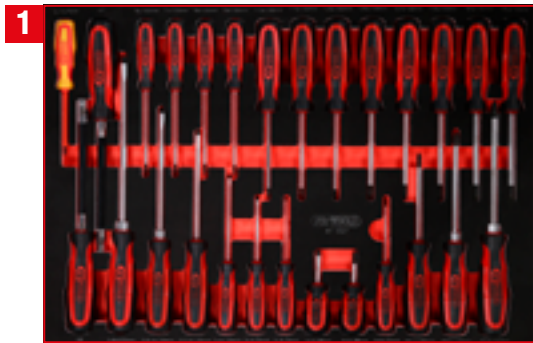

Screwdriver set in foam insert

811.0027

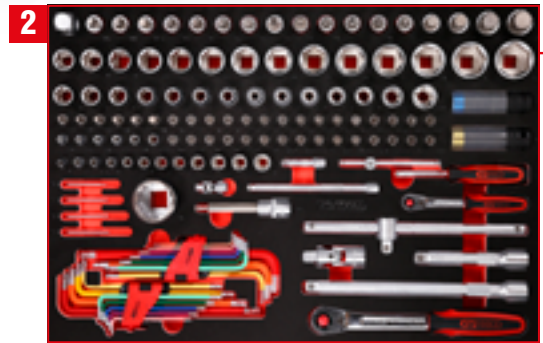

1/4" + 1/2" socket spanner set in foam insert

811.1137

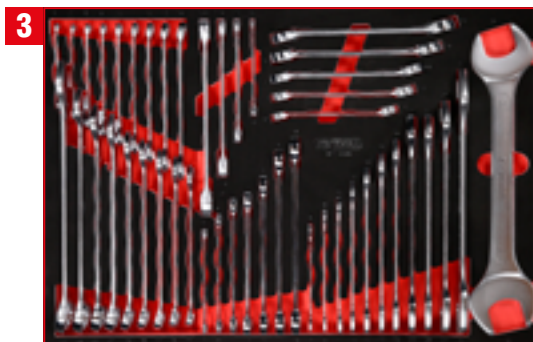

Screw spanner set in foam insert

811.0046

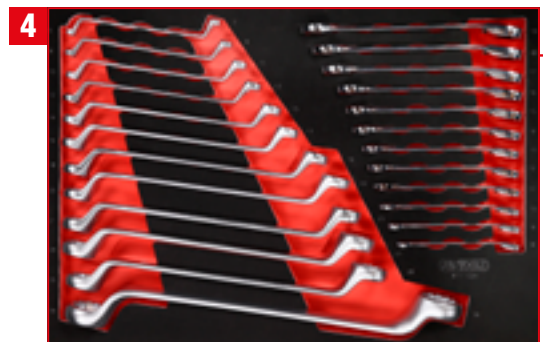

Screw spanner set in foam insert

811.1024



Pliers and file set in foam insert

811.0019



Hammer and chisel set in foam insert

811.0022

811.0027

M Screwdriver set

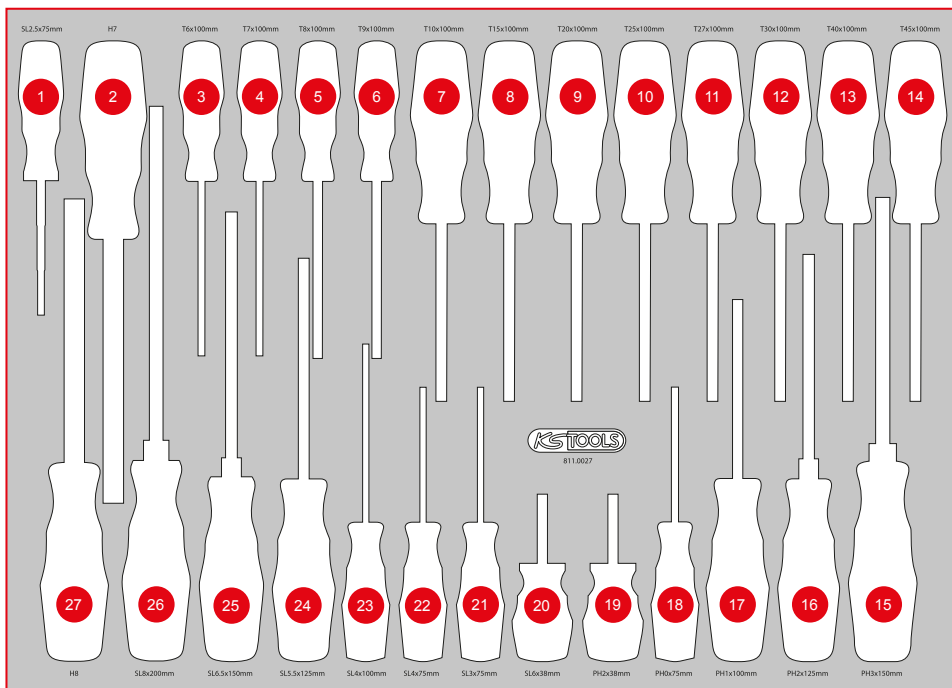
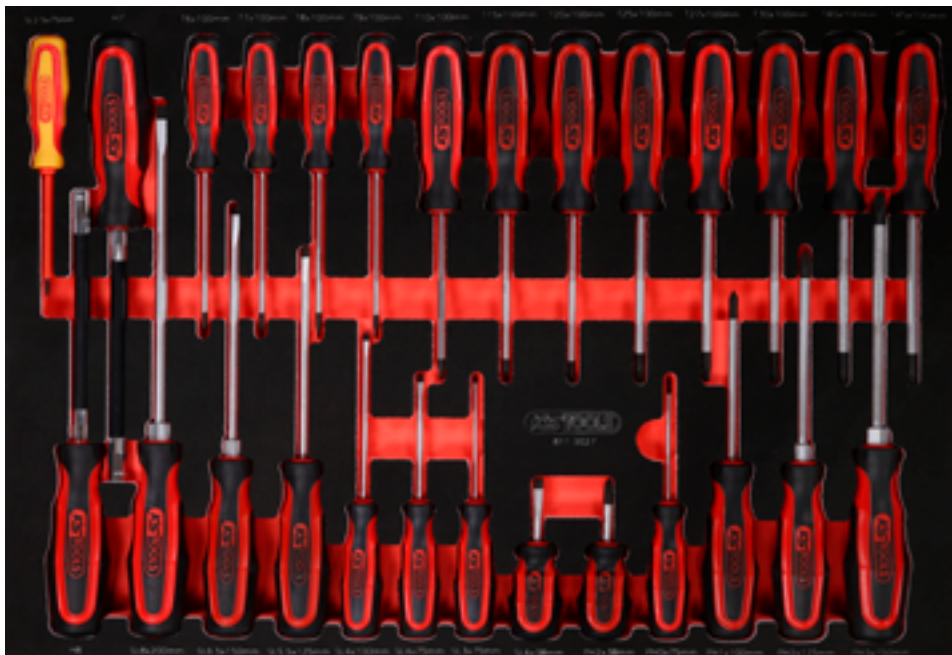

Pos.	Code	Description	pcs
1	117.0502	ERGOTORQUE VDE slot screwdriver, 2,5 mm	1
2	159.1127	ERGOTORQUEplus Socket screwdriver, 7 mm	1
3	159.1134	ERGOTORQUEplus screwdriver, Torx, T6	1
4	159.1135	ERGOTORQUEplus screwdriver, Torx, T7	1
5	159.1030	ERGOTORQUEplus screwdriver, Torx, T8	1
6	159.1031	ERGOTORQUEplus screwdriver, Torx, T9	1
7	159.1032	ERGOTORQUEplus screwdriver, Torx, T10	1
8	159.1033	ERGOTORQUEplus screwdriver, Torx, T15	1
9	159.1034	ERGOTORQUEplus screwdriver, Torx, T20	1
10	159.1035	ERGOTORQUEplus screwdriver, Torx, T25	1
11	159.1036	ERGOTORQUEplus screwdriver, Torx, T27	1
12	159.1037	ERGOTORQUEplus screwdriver, Torx, T30	1
13	159.1038	ERGOTORQUEplus screwdriver, Torx, T40	1
14	159.1136	ERGOTORQUEplus screwdriver, Torx, T45	1
15	159.2128	ERGOTORQUEplus Socket screwdriver, 8 mm	1
16	159.1011	ERGOTORQUEplus screwdriver for slotted screws, 8 mm, 315 mm	1
17	159.1009	ERGOTORQUEplus screwdriver for slotted screws, 6,5 mm, 255 mm	1
18	159.1006	ERGOTORQUEplus screwdriver for slotted screws, 5,5 mm, 230 mm	1
19	159.1004	ERGOTORQUEplus screwdriver for slotted screws, 4 mm, 180 mm	1
20	159.1003	ERGOTORQUEplus screwdriver for slotted screws, 4 mm, 155 mm	1
21	159.1002	ERGOTORQUEplus screwdriver for slotted screws, 3 mm, 155 mm	1
22	159.1001	ERGOTORQUEplus screwdriver for slotted screws, 6 mm, stubby	1
23	159.1026	ERGOTORQUEplus screwdriver for screws PH, PH2, stubby	1
24	159.1027	ERGOTORQUEplus screwdriver for screws PH, PH0, 155 mm	1
25	159.1029	ERGOTORQUEplus screwdriver for screws PH, PH1, 205 mm	1
26	159.1022	ERGOTORQUEplus screwdriver for screws PH, PH2, 230 mm	1
27	159.1024	ERGOTORQUEplus screwdriver for screws PH, PH3, 265 mm	1

811.1137

M 1/4" + 1/2" socket spanner set

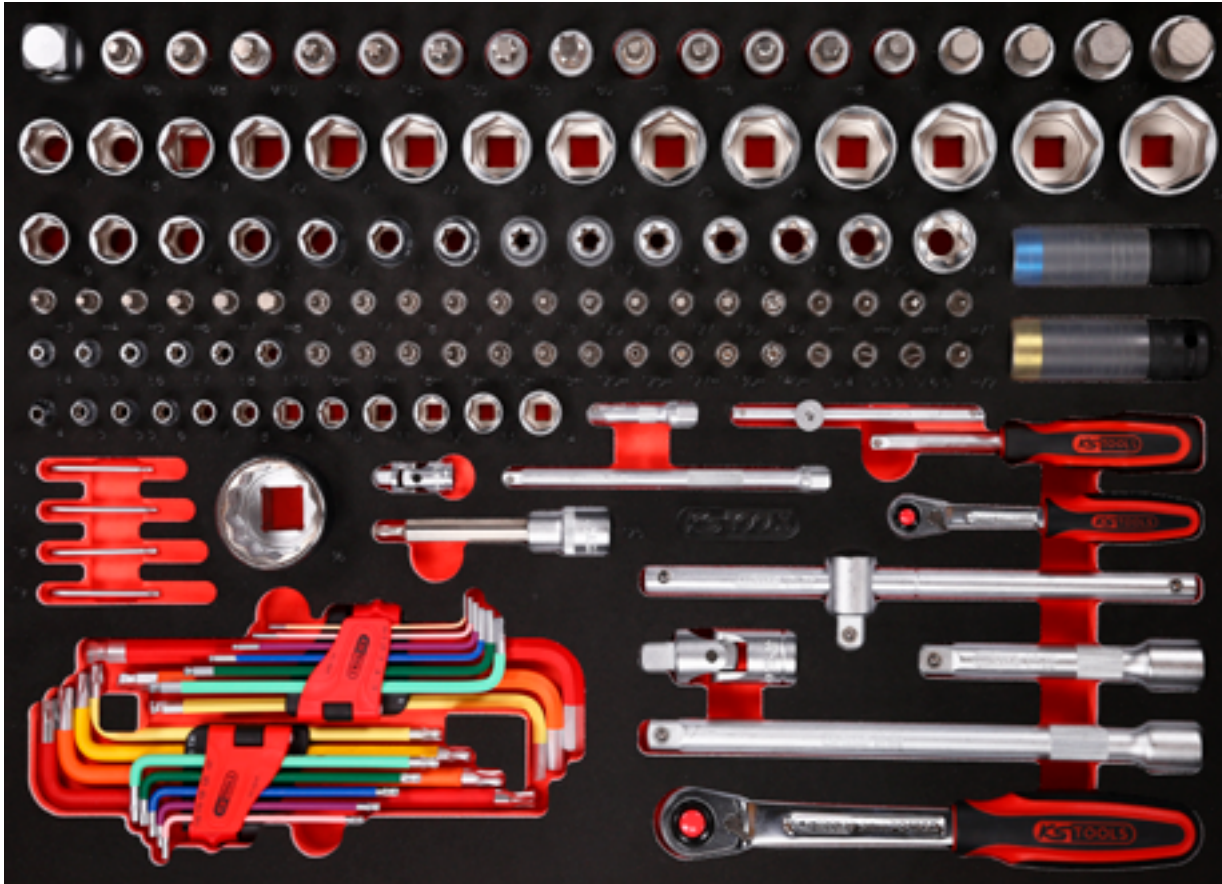

Pos.	Code	Description	pcs	Pos.	Code	Description	pcs	Pos.	Code	Description	pcs
1	911.1234	Adaptor, 1/2" F x 3/4" M	1	22	917.1220	1/2" Hexagonal socket, 20 mm	1	43	911.4322	1/2" Torx E Socket, E16	1
2	911.1341	1/2" Bit socket spline (XZN), M6, 55 mm	1	23	917.1221	1/2" Hexagonal socket, 21 mm	1	44	911.4323	1/2" Torx E Socket, E18	1
3	911.1342	1/2" Bit socket spline (XZN), M8, 55 mm	1	24	917.1222	1/2" Hexagonal socket, 22 mm	1	45	911.4324	1/2" Torx E Socket, E20	1
4	911.1343	1/2" Bit socket spline (XZN), M10, 55 mm	1	25	917.1223	1/2" Hexagonal socket, 23 mm	1	46	911.4326	1/2" Torx E Socket, E24	1
5	911.1365	1/2" Bit socket Torx, T40	1	26	917.1224	1/2" Hexagonal socket, 24 mm	1	47	911.1436	1/4" Bit socket hexagon, 3 mm	1
6	911.1366	1/2" Bit socket Torx, T45	1	27	917.1342	1/2" Hexagonal socket, 25 mm	1	48	911.1437	1/4" Bit socket hexagon, 4 mm	1
7	911.1367	1/2" Bit socket Torx, T50	1	28	917.1343	1/2" Hexagonal socket, 26 mm	1	49	911.1438	1/4" Bit socket hexagon, 5 mm	1
8	911.1368	1/2" Bit socket Torx, T55	1	29	917.1227	1/2" Hexagonal socket, 27 mm	1	50	911.1439	1/4" Bit socket hexagon, 6 mm	1
9	911.1369	1/2" Bit socket Torx, T60	1	30	917.1344	1/2" Hexagonal socket, 28 mm	1	51	911.1440	1/4" Bit socket hexagon, 7 mm	1
10	911.1305	1/2" Bit socket hexagon, short, 5 mm	1	31	917.1230	1/2" Hexagonal socket, 30 mm	1	52	911.1441	1/4" Bit socket hexagon, 8 mm	1
11	911.1306	1/2" Bit socket hexagon, short, 6 mm	1	32	917.1232	1/2" Hexagonal socket, 32 mm	1	53	911.4407	1/4" Bit socket Torx, T6	1
12	911.1307	1/2" Bit socket hexagon, short, 7 mm	1	33	917.1216	1/2" Hexagonal socket, 16 mm	1	54	911.4362	1/4" Bit socket Torx, T7	1
13	911.1308	1/2" Bit socket hexagon, short, 8 mm	1	34	917.1215	1/2" Hexagonal socket, 15 mm	1	55	911.1448	1/4" Bit socket Torx, T8	1
14	911.1310	1/2" Bit socket hexagon, short, 10 mm	1	35	917.1214	1/2" Hexagonal socket, 14 mm	1	56	911.1478	1/4" Bit socket Torx, T9	1
15	911.1312	1/2" Bit socket hexagon, short, 12 mm	1	36	917.1213	1/2" Hexagonal socket, 13 mm	1	57	911.1442	1/4" Bit socket Torx, T10	1
16	911.1314	1/2" Bit socket hexagon, short, 14 mm	1	37	917.1212	1/2" Hexagonal socket, 12 mm	1	58	911.1443	1/4" Bit socket Torx, T15	1
17	911.1317	1/2" Bit socket hexagon, short, 17 mm	1	38	917.1211	1/2" Hexagonal socket, 11 mm	1	59	911.1444	1/4" Bit socket Torx, T20	1
18	911.1319	1/2" Bit socket hexagon, short, 19 mm	1	39	917.1210	1/2" Hexagonal socket, 10 mm	1	60	911.1445	1/4" Bit socket Torx, T25	1
19	917.1217	1/2" Hexagonal socket, 17 mm	1	40	911.4334	1/2" Torx E Socket, E11	1	61	911.1449	1/4" Bit socket Torx, T27	1
20	917.1218	1/2" Hexagonal socket, 18 mm	1	41	911.4335	1/2" Torx E Socket, E12	1	62	911.1446	1/4" Bit socket Torx, T30	1
21	917.1219	1/2" Hexagonal socket, 19 mm	1	42	911.4336	1/2" Torx E Socket, E14	1	63	911.1447	1/4" Bit socket Torx, T40	1

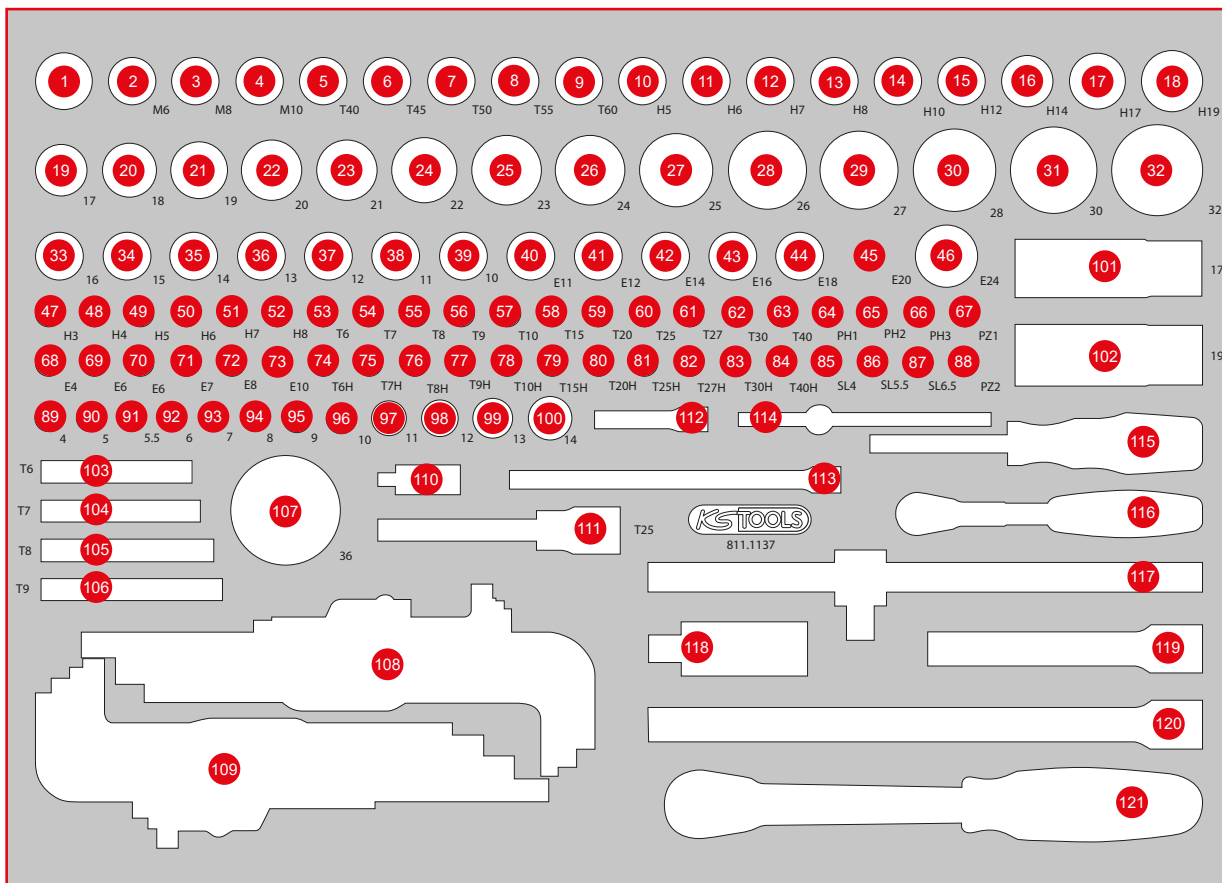

Pos.	Code	Description	pcs	Pos.	Code	Description	pcs	Pos.	Code	Description	pcs
64	911.1415	1/4" Bit socket, PH1	1	85	911.1418	1/4" Bit socket slot, 4 mm	1	106	151.2344	Torx key wrench, short, T9	1
65	911.1416	1/4" Bit socket, PH2	1	86	911.1419	1/4" Bit socket slot, 5,5 mm	1	107	911.3548	3/4" 12 Point socket, short, 36 mm	1
66	911.1417	1/4" Bit socket, PH3	1	87	917.1421	1/4" Bit socket slot, 6,5 mm	1	108	151.4530	Ball ended Torx key wrench set, extra long and bent 108°, 9 pcs	9
67	911.1401	1/4" Bit socket, PZ1	1	88	911.1402	1/4" Bit socket, PZ2	1	109	151.4420	Ball ended hexagon key wrench set, extra long, 9 pcs	9
68	911.4313	1/4" Torx E Socket, E4	1	89	917.1404	1/4" Hexagonal socket, 4 mm	1	110	911.1450	1/4" Universal joint	1
69	911.4314	1/4" Torx E Socket, E5	1	90	917.1405	1/4" Hexagonal socket, 5 mm	1	111	918.1643	1/2" CHROMEplus Bit socket Torx, long, T25	1
70	911.4315	1/4" Torx E Socket, E6	1	91	917.14055	1/4" Hexagonal socket, 5,5 mm	1	112	911.1423	1/4" Extension with hexagon drive, 50 mm	1
71	911.4316	1/4" Torx E Socket, E7	1	92	917.1406	1/4" Hexagonal socket, 6 mm	1	113	911.1451	1/4" Extension with hexagon drive, 150 mm	1
72	911.4317	1/4" Torx E Socket, E8	1	93	917.1407	1/4" Hexagonal socket, 7 mm	1	114	911.1425	Sliding T-bar, 1/4", 110 mm	1
73	911.4332	1/4" Torx E Socket, E10	1	94	917.1408	1/4" Hexagonal socket, 8 mm	1	115	911.1434	1/4" Square drive screwdriver, 150 mm	1
74	917.1456	1/4" Bit socket Torx tamperproof, TB6	1	95	917.1409	1/4" Hexagonal socket, 9 mm	1	116	920.1490	1/4" SlimPOWER Reversible ratchet, 72 teeth	1
75	917.1457	1/4" Bit socket Torx tamperproof, TB7	1	96	917.1410	1/4" Hexagonal socket, 10 mm	1	117	911.1204	Sliding T-bar, 1/2", 250 mm	1
76	911.1461	1/4" Bit socket Torx tamperproof, TB8	1	97	917.1411	1/4" Hexagonal socket, 11 mm	1	118	911.1250	1/2" Universal joint	1
77	911.1485	1/4" Bit socket Torx tamperproof, TB9	1	98	917.1412	1/4" Hexagonal socket, 12 mm	1	119	911.1202	1/2" Extensions, 125 mm	1
78	911.1462	1/4" Bit socket Torx tamperproof, TB10	1	99	917.1413	1/4" Hexagonal socket, 13 mm	1	120	911.1203	1/2" Extensions, 250 mm	1
79	911.1463	1/4" Bit socket Torx tamperproof, TB15	1	100	917.1414	1/4" Hexagonal socket, 14 mm	1	121	920.1290	1/2" SlimPOWER Reversible ratchet, 72 teeth	1
80	911.1464	1/4" Bit socket Torx tamperproof, TB20	1	101	515.0992	SlimPOWER 1/2" Alloy rim impact socket, 17 mm	1				
81	911.1465	1/4" Bit socket Torx tamperproof, TB25	1	102	515.0993	SlimPOWER 1/2" Alloy rim impact socket, 19 mm	1				
82	911.1466	1/4" Bit socket Torx tamperproof, TB27	1	103	151.2341	Torx key wrench, short, T6	1				
83	911.1467	1/4" Bit socket Torx tamperproof, TB30	1	104	151.2342	Torx key wrench, short, T7	1				
84	911.1468	1/4" Bit socket Torx tamperproof, TB40	1	105	151.2343	Torx key wrench, short, T8	1				

811.0046

M Screw spanner set



568 x 398



P10



P10TC



P15



P20



P30



P35



P45



Pos.	Code	Description	pcs	Pos.	Code	Description	pcs	Pos.	Code	Description	pcs
1	517.0606	Combination spanners, offset, 6 mm	1	10	517.0615	Combination spanners, offset, 15 mm	1	19	911.0371	Double ring spanner for Torx E profile, E6 x E8	1
2	517.0607	Combination spanners, offset, 7 mm	1	11	517.0616	Combination spanners, offset, 16 mm	1	20	911.0373	Double ring spanner for Torx E profile, E10 x E12	1
3	517.0608	Combination spanners, offset, 8 mm	1	12	517.0617	Combination spanners, offset, 17 mm	1	21	911.0374	Double ring spanner for Torx E profile, E14 x E18	1
4	517.0609	Combination spanners, offset, 9 mm	1	13	517.0618	Combination spanners, offset, 18 mm	1	22	911.0376	Double ring spanner for Torx E profile, E20 x E24	1
5	517.0610	Combination spanners, offset, 10 mm	1	14	517.0619	Combination spanners, offset, 19 mm	1	23	920.0406	ULTIMATEplus Double ring ended spanner, 6 x 7 mm	1
6	517.0611	Combination spanners, offset, 11 mm	1	15	517.0621	Combination spanners, offset, 21 mm	1	24	920.0408	ULTIMATEplus Double ring ended spanner, 8 x 9 mm	1
7	517.0612	Combination spanners, offset, 12 mm	1	16	517.0622	Combination spanners, offset, 22 mm	1				
8	517.0613	Combination spanners, offset, 13 mm	1	17	517.0624	Combination spanners, offset, 24 mm	1				
9	517.0614	Combination spanners, offset, 14 mm	1	18	517.0627	Combination spanners, offset, 27 mm	1				

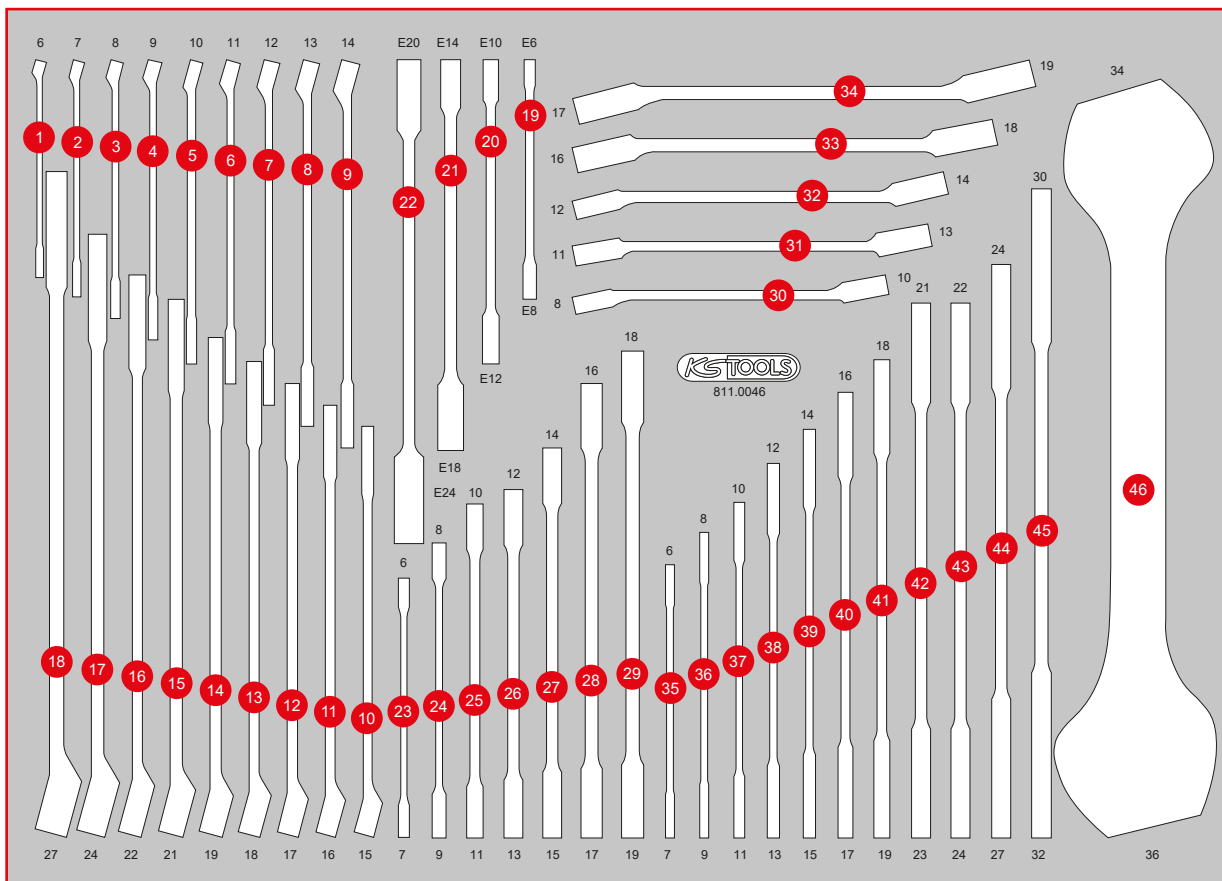

Pos.	Code	Description	pcs	Pos.	Code	Description	pcs	Pos.	Code	Description	pcs
25	920.0410	ULTIMATEplus Double ring ended spanner, 10 x 11 mm	1	30	517.0252	Open double ring spanner, offset, 8 x 10 mm	1	39	517.0709	Double open ended spanners, 14 x 15 mm	1
26	920.0412	ULTIMATEplus Double ring ended spanner, 12 x 13 mm	1	31	517.9244	Open double ring spanner, offset, 11 x 13 mm	1	40	517.0710	Double open ended spanners, 16 x 17 mm	1
27	920.0414	ULTIMATEplus Double ring ended spanner, 14 x 15 mm	1	32	517.0258	Open double ring spanner, offset, 12 x 14 mm	1	41	517.0712	Double open ended spanners, 18 x 19 mm	1
28	920.0416	ULTIMATEplus Double ring ended spanner, 16 x 17 mm	1	33	517.0263	Open double ring spanner, offset, 16 x 18 mm	1	42	517.0715	Double open ended spanners, 21 x 23 mm	1
29	920.0418	ULTIMATEplus Double ring ended spanner, 18 x 19 mm	1	34	517.0264	Open double ring spanner, offset, 17 x 19 mm	1	43	517.0736	Double open ended spanners, 22 x 24 mm	1
				35	517.0701	Double open ended spanners, 6 x 7 mm	1	44	517.0716	Double open ended spanners, 24 x 27 mm	1
				36	517.0702	Double open ended spanners, 8 x 9 mm	1	45	517.0718	Double open ended spanners, 30 x 32 mm	1
				37	517.0704	Double open ended spanners, 10 x 11 mm	1	46	517.0773	Double open ended spanners, 34 x 36 mm	1
				38	517.0707	Double open ended spanners, 12 x 13 mm	1				

811.1024

M Screw spanner set

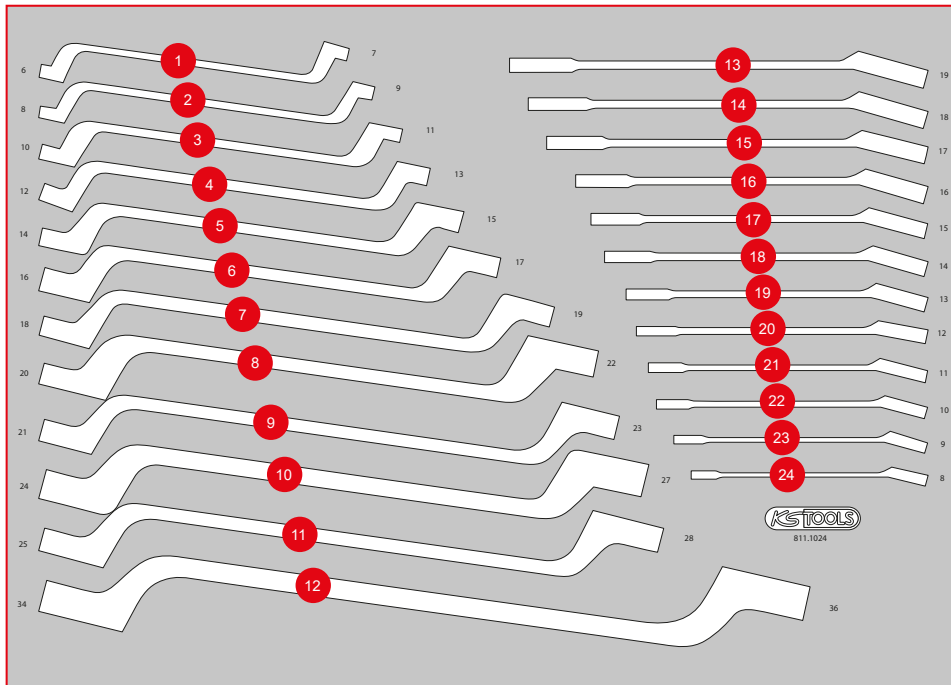
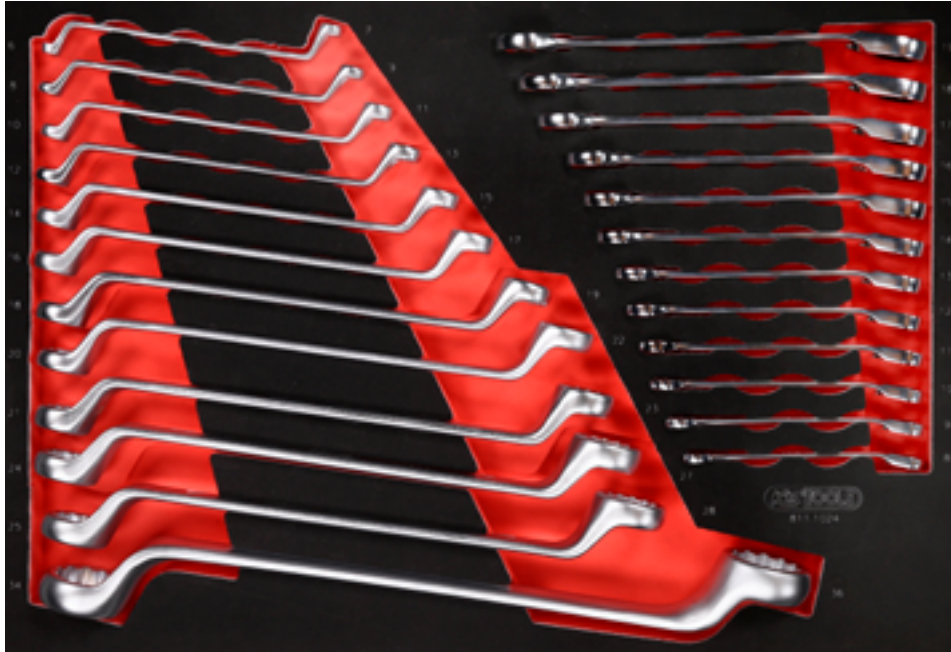

Pos.	Code	Description	pcs
1	517.0801	Double ring spanner, offset, 6 x 7 mm	1
2	517.0802	Double ring spanner, offset, 8 x 9 mm	1
3	517.0804	Double ring spanner, offset, 10 x 11 mm	1
4	517.0807	Double ring spanner, offset, 12 x 13 mm	1
5	517.0809	Double ring spanner, offset, 14 x 15 mm	1
6	517.0810	Double ring spanner, offset, 16 x 17 mm	1
7	517.0812	Double ring spanner, offset, 18 x 19 mm	1
8	517.0813	Double ring spanner, offset, 20 x 22 mm	1
9	517.0815	Double ring spanner, offset, 21 x 23 mm	1
10	517.0816	Double ring spanner, offset, 24 x 27 mm	1
11	517.0857	Double ring spanner, offset, 25 x 28 mm	1
12	517.0818	Double ring spanner, offset, 30 x 32 mm	1
13	503.4619	GEARplus reversing combination ratcheting spanner, 19 mm	1
14	503.4618	GEARplus reversing combination ratcheting spanner, 18 mm	1
15	503.4617	GEARplus reversing combination ratcheting spanner, 17 mm	1
16	503.4616	GEARplus reversing combination ratcheting spanner, 16 mm	1
17	503.4615	GEARplus reversing combination ratcheting spanner, 15 mm	1
18	503.4614	GEARplus reversing combination ratcheting spanner, 14 mm	1
19	503.4613	GEARplus reversing combination ratcheting spanner, 13 mm	1
20	503.4612	GEARplus reversing combination ratcheting spanner, 12 mm	1
21	503.4611	GEARplus reversing combination ratcheting spanner, 11 mm	1
22	503.4610	GEARplus reversing combination ratcheting spanner, 10 mm	1
23	503.4609	GEARplus reversing combination ratcheting spanner, 9 mm	1
24	503.4608	GEARplus reversing combination ratcheting spanner, 8 mm	1

811.0019

M Pliers and file set



P10

P10TC

P15

P20

P30

P35

P45

568 x 398



Pos.	Code	Description	pcs
1	157.0405	Tri-bastard file, form C, cut 2, 200 mm	1
2	157.0105	Halfround file, form E, cut 2, 20 mm	1
3	157.0005	Flat file, form B, cut 2, 200 mm	1
4	157.0205	Round file, form F, cut 2, 200 mm	1
5	907.2166	Snap off blades 0,5 x 1 8 x 100 mm, dispenser with 10 pieces	10
6	300.0114	Tape measure with locking device and belt clip, black red, 5 m, 19 mm	1
7	300.0510	Pocket vernier calliper 0-150 mm, 235 mm	1
8	300.0600	Feeler gauge, 20 Blades, 0,05-1 mm	1
9	907.2135	Universal snap off blade knife 18 mm	1
10	115.1033	Self grip wrench, 220 mm	1
11	115.2010	Water pump pliers, 240 mm	1
12	500.1026	Circlip pliers for external circlips, angled, 160 mm	1
13	500.1029	Circlip pliers for external circlips, 160 mm	1
14	500.1032	Circlip pliers for internal circlips, angled, 160 mm	1
15	500.1035	Circlip pliers for internal circlips, 160 mm	1
16	115.1012	ERGOTORQUE diagonal side cutter, 160 mm	1
17	115.1021	ERGOTORQUE combination pliers, 180 mm	1
18	115.1019	ERGOTORQUE bent nose pliers serrated, 210 mm	1
19	115.1024	ERGOTORQUE long nose pliers serrated cutter, 200 mm	1

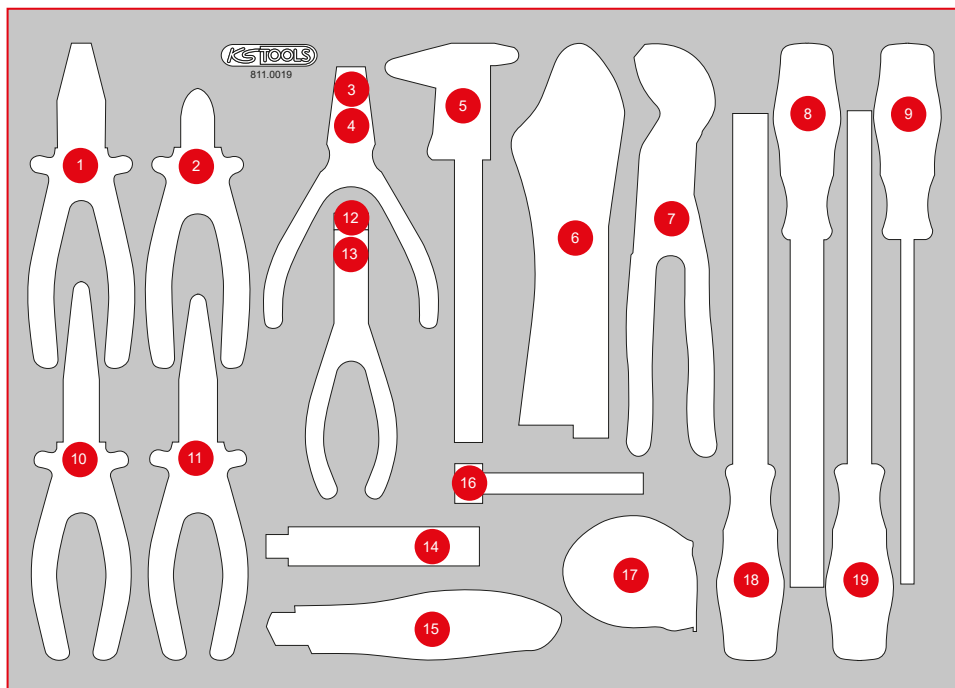

811.0022

M Hammer and chisel set



Pos.	Code	Description	pcs
1	911.8138	Trim plastic wedge, 195 x 30 mm	1
2	140.5252	Recoil free soft faced Hammer, 400 g	1
3	142.1402	Fitters Hammer, fiberglas handle, 400 g	1
4	142.5101	Club Hammer, fiberglas handle, 1000 g	1
5	550.1025	Flexible magnet lifter, 510 mm, Øhead=15 mm	1
6	550.1001	2in1 Telescopic solenoid holder with washer jet cleaning and setting tool, 150 - 675 mm	1
7	150.4370	perfectLight torch 85 lumen	1
8	911.8146	Tyre lever, 370 mm	1
9	201.2335	Steel wire brake saddle brush, 2-row, straight 225 mm	1
10	156.0241	Flat chisel, octagon, 20 mm	1
11	156.0254	Flat chisel, octagon, 18 mm	1
12	156.0242	Cross chisel, octagon, 7 mm	1
13	156.0243	Centre punch, octagon 10 mm	1
14	156.0244	Punch, Ø 5 mm, conical	1
15	156.0238	Punch, Ø 4 mm, conical	1
16	156.0237	Punch, Ø 3 mm, conical	1
17	156.0231	Pin punch, Ø 3 mm, cylindrical shaft	1
18	156.0232	Pin punch, Ø 4 mm, cylindrical shaft	1
19	156.0233	Pin punch, Ø 5 mm, cylindrical shaft	1
20	156.0234	Pin punch, Ø 6 mm, cylindrical shaft	1
21	156.0235	Pin punch, Ø 8 mm, cylindrical shaft	1
22	907.2232	Gasket scraper, 25 x 200 mm	1

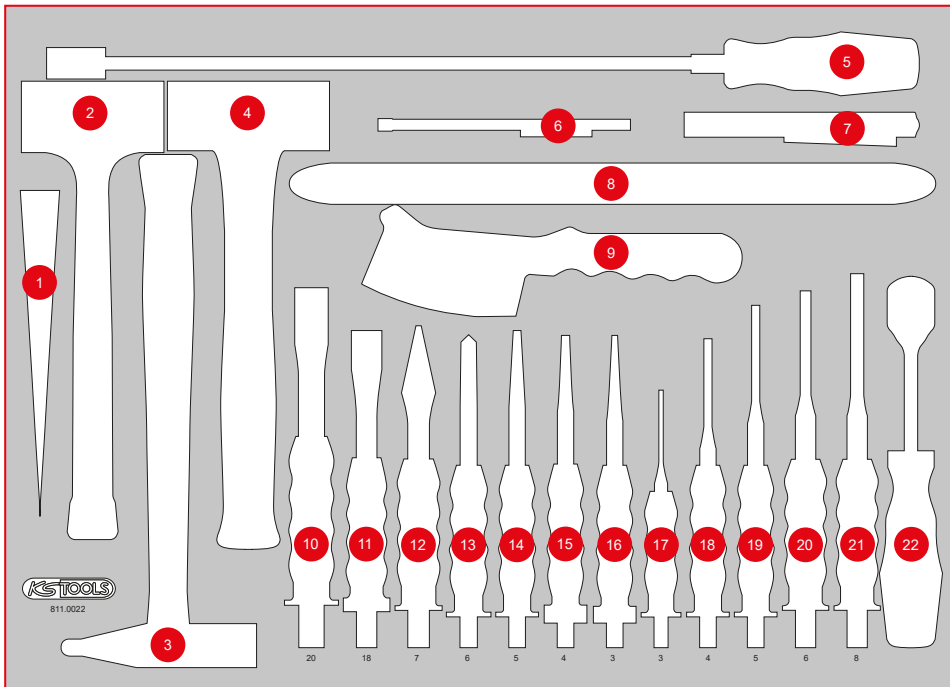

P10

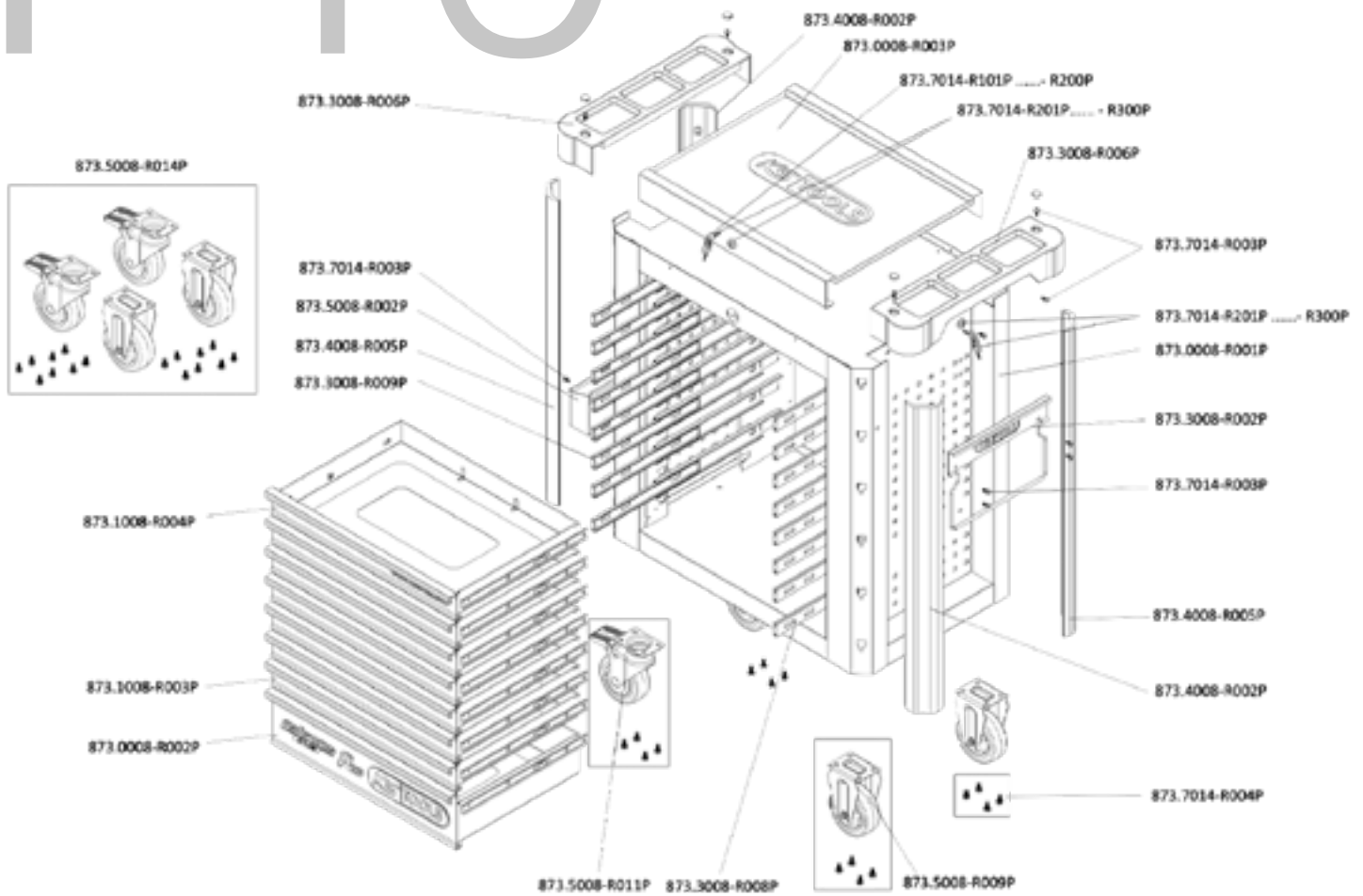

INDIVIDUAL PARTS LIST

Item No.	Description	Amount
873.7014-R101P...	Replacement key for PERFORMANCEplus workshop trolley lock number xyz	2
873.7014-R201P...	Lock with 2 keys for PERFORMANCEplus workshop trolley lock number xyz	2
873.0008-R001P	Body with handle	1
873.0008-R002P	Compartment with logo and ball-bearing guide, 568x398x145 mm	1
873.0008-R003P	Stainless steel worktop	1
873.1008-R003P	Compartment with ball-bearing guide, for workshop trolley P10/P10TC/P15, 568x398x65 mm	6
873.1008-R004P	Compartment with website and ball-bearing guide, for workshop trolley P10/P15, 568x398x65 mm	1
873.3008-R002P	Paper roll holder for PERFORMANCEplus workshop trolley	1
873.3008-R006P	Storage for work surface	2
873.3008-R008P	Full extension (with ball-bearing guide) with automatic retraction	8
873.3008-R009P	Full extension (with ball-bearing guide) with automatic retraction	8
873.4008-R002P	Plastic bumpers	2
873.4008-R005P	Plastic bumpers	2
873.5008-R002P	Can holder for PERFORMANCEplus workshop trolley	1
873.5008-R009P	Fixed castors for PERFORMANCEplus workshop trolley, incl. screws	2
873.5008-R011P	Swivel castors with brakes, for PERFORMANCEplus workshop trolley, incl. screws	2
873.5008-R014P	Roller set for PERFORMANCEplus workshop trolley, incl. screws	1
873.7014-R003P	M6x12 screws for PERFORMANCEplus workshop trolley accessories	14
873.7014-R004P	M8 screws for PERFORMANCEplus workshop trolley rollers (16 pcs.)	1



873.7014-R101P...R200P
Replacement key for lock number xyz



873.7014-R201P...R300P
Lock with 2 keys for lock number xyz



873.3008-R008P
Full extension (with ball-bearing guide) with automatic retraction, right



873.3008-R009P
Full extension (with ball-bearing guide) with automatic retraction, left



873.5008-R009P
Fixed castors, incl. screws



873.5008-R011P
Swivel castors with brakes, incl. screws



873.5008-R014P
Roller set, incl. screws



873.0008-R003P
Stainless steel work surface



873.3008-R006P
Storage for work surface, including screw cover, usable on both sides



873.1008-R004P
Compartment with website and ball-bearing guide, 568x398x65 mm



873.1008-R003P
Compartment with ball-bearing guide, 568x398x65 mm



873.0008-R002P
Compartment with logo and ball-bearing guide, 568x398x145 mm



873.5008-R002P
Can holder, 310 mm



873.3008-R002P
Paper roll holder, 320 mm



873.4008-R005P
Plastic bumpers, front left, back right



873.4008-R002P
Plastic bumpers, front right, back left



873.7014-R004P
M8 screws (16 pcs.)



873.7014-R003P
M6x12 screw (1 pcs.)



873.0008-R001P
Body with handle



A thousand great parts for tough guys!

