

P10

workshop tool trolley
with 262 tools for 5 drawers
810.5262

Workshop trolley P10

with 8 compartments

873.0008

THE ENTRY MODEL TO SATISFY HIGH STANDARDS



P10



DUO Lock Brilliant locking system



Eight drawers each load capacity up to 50 kg



Stable **ball bearing**



Stainless steel surface

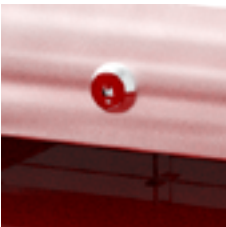

Lock lockable



Anti-static castors with brakes



Integrated **corner protection**



Paper roll holder included



Can holder included

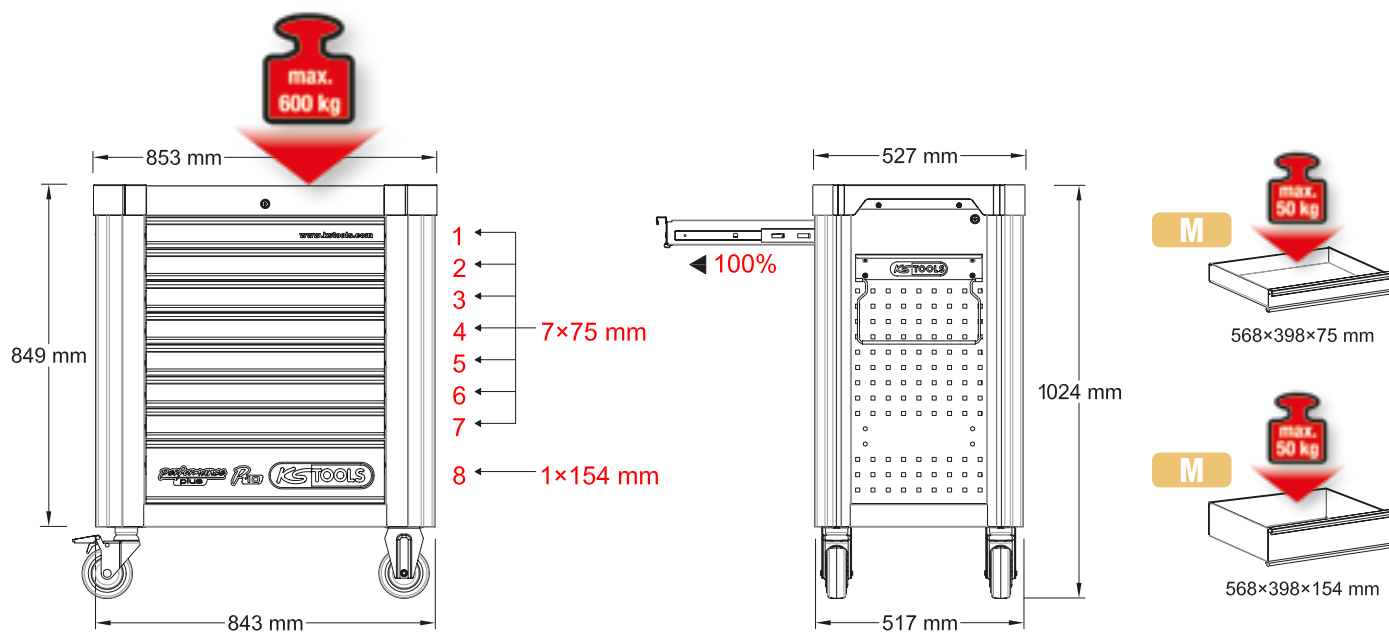

P10 workshop tool trolley set with 262 tools for 5 drawers

810.5262



M

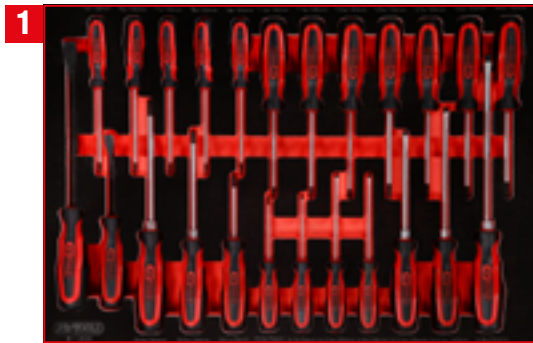

Screwdriver set in foam insert

811.0024

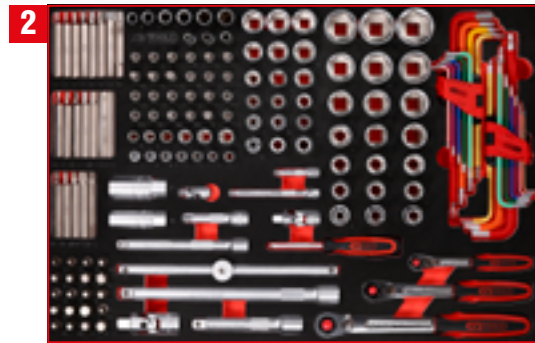

1/4" + 3/8" + 1/2" socket spanner set
in foam insert

811.0159

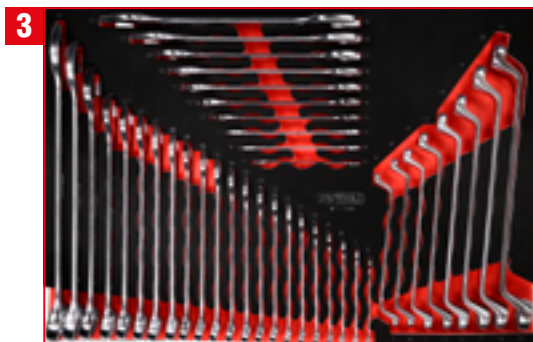

Screw spanner set in foam insert

811.1040

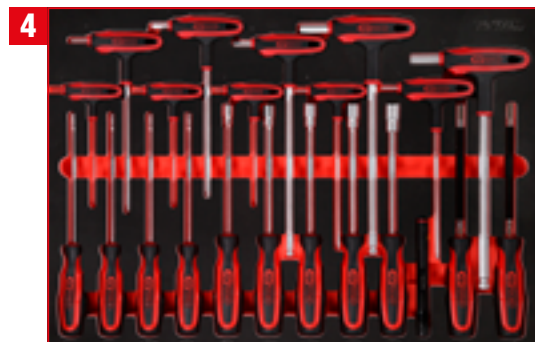

T-handle and screwdriver set in foam
insert

811.1022



Pliers, hammer and chisel set in foam
insert

811.0017

811.0024

M Screwdriver set

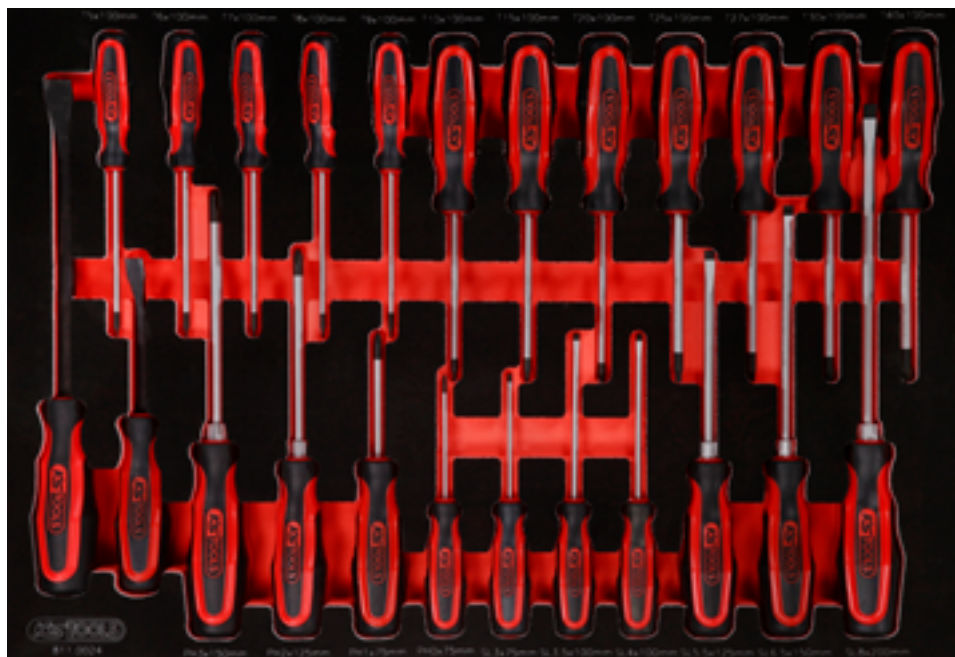

Pos.	Code	Description	pcs
1	911.8102	Pry bar, 15 x 185 mm	1
2	911.8101	Pry bar, 11 x 115 mm	1
3	159.1133	ERGOTORQUEplus screwdriver, Torx, T5	1
4	159.1134	ERGOTORQUEplus screwdriver, Torx, T6	1
5	159.1135	ERGOTORQUEplus screwdriver, Torx, T7	1
6	159.1030	ERGOTORQUEplus screwdriver, Torx, T8	1
7	159.1031	ERGOTORQUEplus screwdriver, Torx, T9	1
8	159.1032	ERGOTORQUEplus screwdriver, Torx, T10	1
9	159.1033	ERGOTORQUEplus screwdriver, Torx, T15	1
10	159.1034	ERGOTORQUEplus screwdriver, Torx, T20	1
11	159.1035	ERGOTORQUEplus screwdriver, Torx, T25	1
12	159.1036	ERGOTORQUEplus screwdriver, Torx, T27	1
13	159.1037	ERGOTORQUEplus screwdriver, Torx, T30	1
14	159.1038	ERGOTORQUEplus screwdriver, Torx, T40	1
15	159.1024	ERGOTORQUEplus screwdriver, Torx, PH3, 265 mm	1
16	159.1022	ERGOTORQUEplus screwdriver, Torx, PH2, 230 mm	1
17	159.1020	ERGOTORQUEplus screwdriver, Torx, PH1, 180 mm	1
18	159.1027	ERGOTORQUEplus screwdriver, Torx, PH0, 155 mm	1
19	159.1002	ERGOTORQUEplus screwdriver for slotted screws, 3 mm, 155 mm	1
20	159.1112	ERGOTORQUEplus screwdriver for slotted screws, 3,5 mm, 180 mm	1
21	159.1004	ERGOTORQUEplus screwdriver for slotted screws, 4 mm, 180 mm	1
22	159.1006	ERGOTORQUEplus screwdriver for slotted screws, 5,5 mm, 230 mm	1
23	159.1009	ERGOTORQUEplus screwdriver for slotted screws, 6,5 mm, 255 mm	1
24	159.1011	ERGOTORQUEplus screwdriver for slotted screws, 8 mm, 315 mm	1

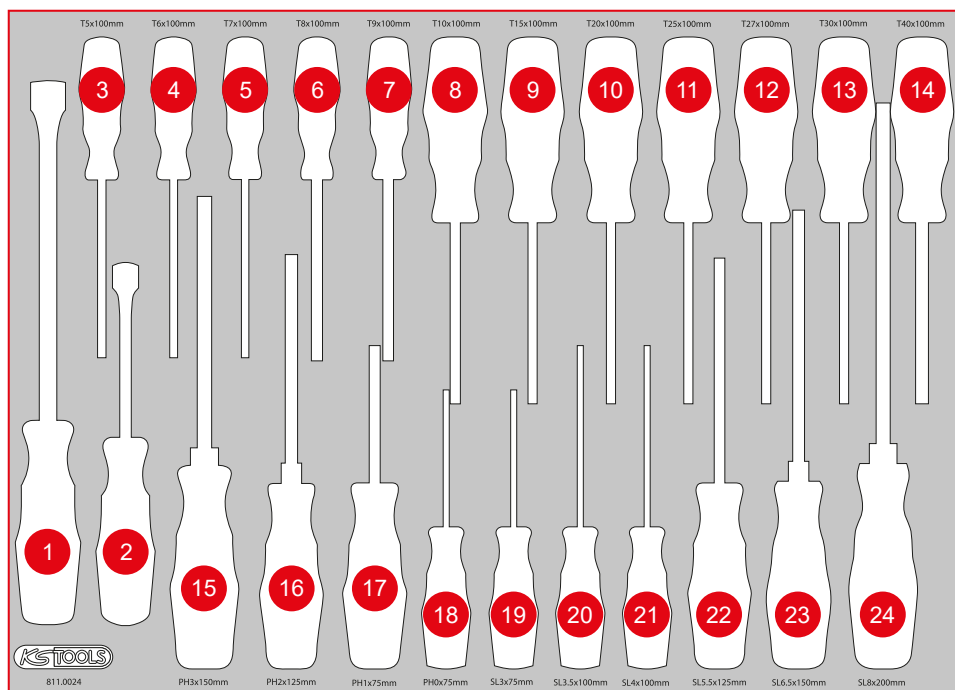

M 1/4" + 3/8" + 1/2" Socket spanner set

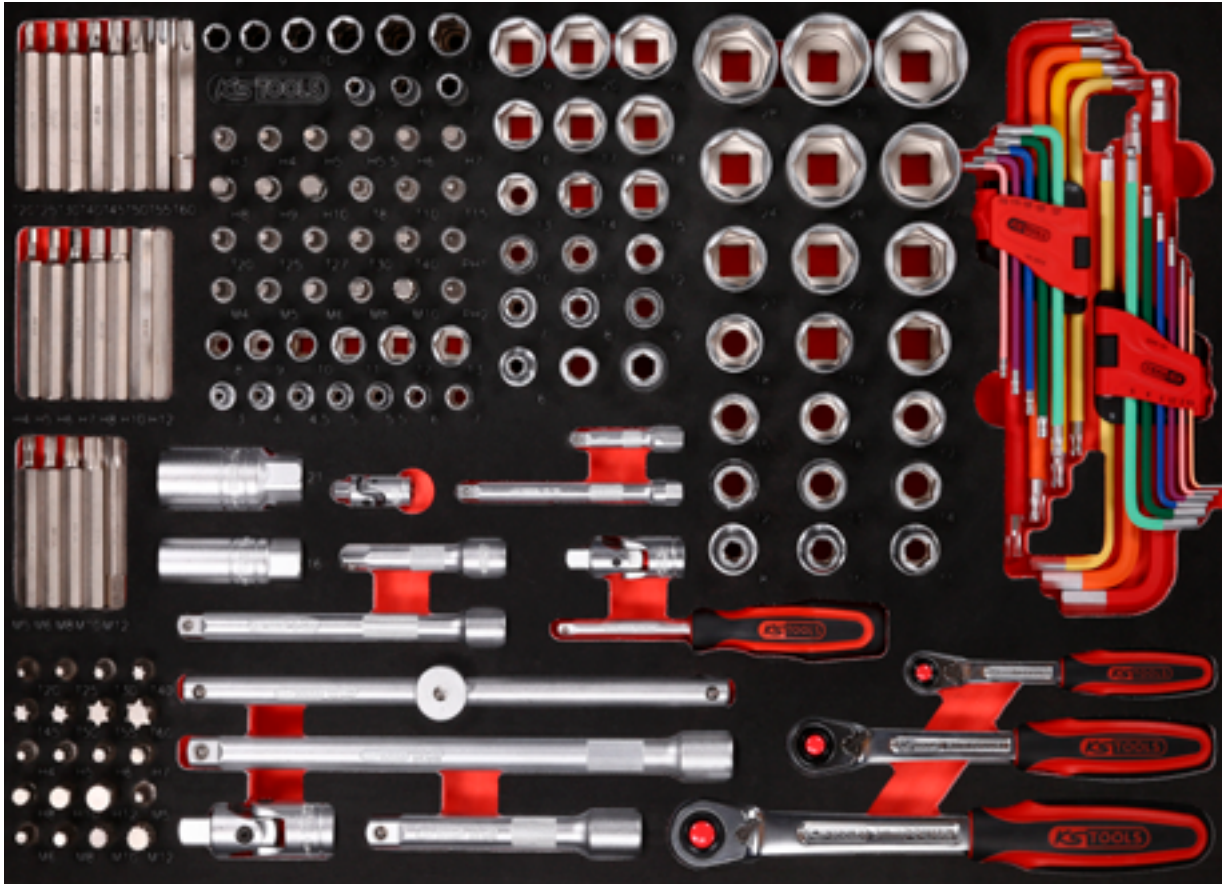
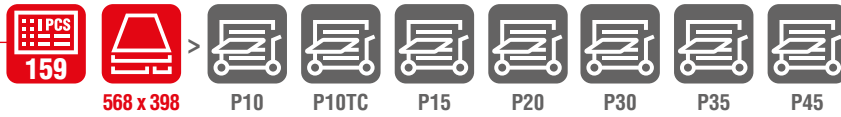

Pos.	Code	Description	pcs	Pos.	Code	Description	pcs	Pos.	Code	Description	pcs
1	975.2020	10 mm Bit Torx, 75 mm, T20	1	26	930.2050	10 mm Bit Torx, 30 mm, T50	1	51	911.1437	1/4" Bit socket hexagon, 4 mm	1
2	975.2025	10 mm Bit Torx, 75 mm, T25	1	27	930.2055	10 mm Bit Torx, 30 mm, T55	1	52	911.1438	1/4" Bit socket hexagon, 5 mm	1
3	975.2030	10 mm Bit Torx, 75 mm, T30	1	28	930.2060	10 mm Bit Torx, 30 mm, T60	1	53	911.14385	1/4" Bit socket hexagon, 5,5 mm	1
4	975.2040	10 mm Bit Torx, 75 mm, T40	1	29	930.1004	10 mm Bit hexagonal, 30 mm, 4 mm	1	54	911.1439	1/4" Bit socket hexagon, 6 mm	1
5	975.2045	10 mm Bit Torx, 75 mm, T45	1	30	930.1005	10 mm Bit hexagonal, 30 mm, 5 mm	1	55	911.1440	1/4" Bit socket hexagon, 7 mm	1
6	975.2050	10 mm Bit Torx, 75 mm, T50	1	31	930.1006	10 mm Bit hexagonal, 30 mm, 6 mm	1	56	911.1441	1/4" Bit socket hexagon, 8 mm	1
7	975.2055	10 mm Bit Torx, 75 mm, T55	1	32	930.1007	10 mm Bit hexagonal, 30 mm, 7 mm	1	57	917.1454	1/4" Bit socket hexagon, 9 mm	1
8	975.2060	10 mm Bit Torx, 75 mm, T60	1	33	930.1008	10 mm Bit hexagonal, 30 mm, 8 mm	1	58	917.1452	1/4" Bit socket hexagon, 10 mm	1
9	975.1004	10 mm Bit hexagonal, 75 mm, 4 mm	1	34	930.1010	10 mm Bit hexagonal, 30 mm, 10 mm	1	59	911.1448	1/4" Bit socket Torx, T8	1
10	975.1005	10 mm Bit hexagonal, 75 mm, 5 mm	1	35	930.1012	10 mm Bit hexagonal, 30 mm, 12 mm	1	60	911.1442	1/4" Bit socket Torx, T10	1
11	975.1006	10 mm Bit hexagonal, 75 mm, 6 mm	1	36	930.3005	10 mm Bit spline XZN, 30 mm, M5	1	61	911.1443	1/4" Bit socket Torx, T15	1
12	975.1007	10 mm Bit hexagonal, 75 mm, 7 mm	1	37	930.3006	10 mm Bit spline XZN, 30 mm, M6	1	62	911.1444	1/4" Bit socket Torx, T20	1
13	975.1008	10 mm Bit hexagonal, 75 mm, 8 mm	1	38	930.3008	10 mm Bit spline XZN, 30 mm, M8	1	63	911.1445	1/4" Bit socket Torx, T25	1
14	975.1010	10 mm Bit hexagonal, 75 mm, 10 mm	1	39	930.3010	10 mm Bit spline XZN, 30 mm, M10	1	64	911.1449	1/4" Bit socket Torx, T27	1
15	975.1012	10 mm Bit hexagonal, 75 mm, 12 mm	1	40	930.3012	10 mm Bit spline XZN, 30 mm, M12	1	65	911.1446	1/4" Bit socket Torx, T30	1
16	975.3005	10 mm Bit spline XZN, 75 mm, M5	1	41	917.1428	1/4" Hexagonal socket, deep, 8 mm	1	66	911.1447	1/4" Bit socket Torx, T40	1
17	975.3006	10 mm Bit spline XZN, 75 mm, M6	1	42	917.1429	1/4" Hexagonal socket, deep, 9 mm	1	67	911.1415	1/4" Bit socket, PH1	1
18	975.3008	10 mm Bit spline XZN, 75 mm, M8	1	43	917.1430	1/4" Hexagonal socket, deep, 10 mm	1	68	917.1541	1/4" Bit socket spline (XZN), M4	1
19	975.3010	10 mm Bit spline XZN, 75 mm, M10	1	44	917.1431	1/4" Hexagonal socket, deep, 11 mm	1	69	917.1542	1/4" Bit socket spline (XZN), M5	1
20	975.3012	10 mm Bit spline XZN, 75 mm, M12	1	45	917.1432	1/4" Hexagonal socket, deep, 12 mm	1	70	917.1543	1/4" Bit socket spline (XZN), M6	1
21	930.2020	10 mm Bit Torx, 30 mm, T20	1	46	917.1433	1/4" Hexagonal socket, deep, 13 mm	1	71	917.1545	1/4" Bit socket spline (XZN), M8	1
22	930.2025	10 mm Bit Torx, 30 mm, T25	1	47	917.1527	1/4" Hexagonal socket, deep, 5 mm	1	72	917.1546	1/4" Bit socket spline (XZN), M10	1
23	930.2030	10 mm Bit Torx, 30 mm, T30	1	48	917.1426	1/4" Hexagonal socket, deep, 6 mm	1	73	911.1416	1/4" Bit socket, PH2	1
24	930.2040	10 mm Bit Torx, 30 mm, T40	1	49	917.1427	1/4" Hexagonal socket, deep, 7 mm	1	74	917.1408	1/4" Hexagonal socket, 8 mm	1
25	930.2045	10 mm Bit Torx, 30 mm, T45	1	50	911.1436	1/4" Bit socket hexagon, 3 mm	1	75	917.1409	1/4" Hexagonal socket, 9 mm	1

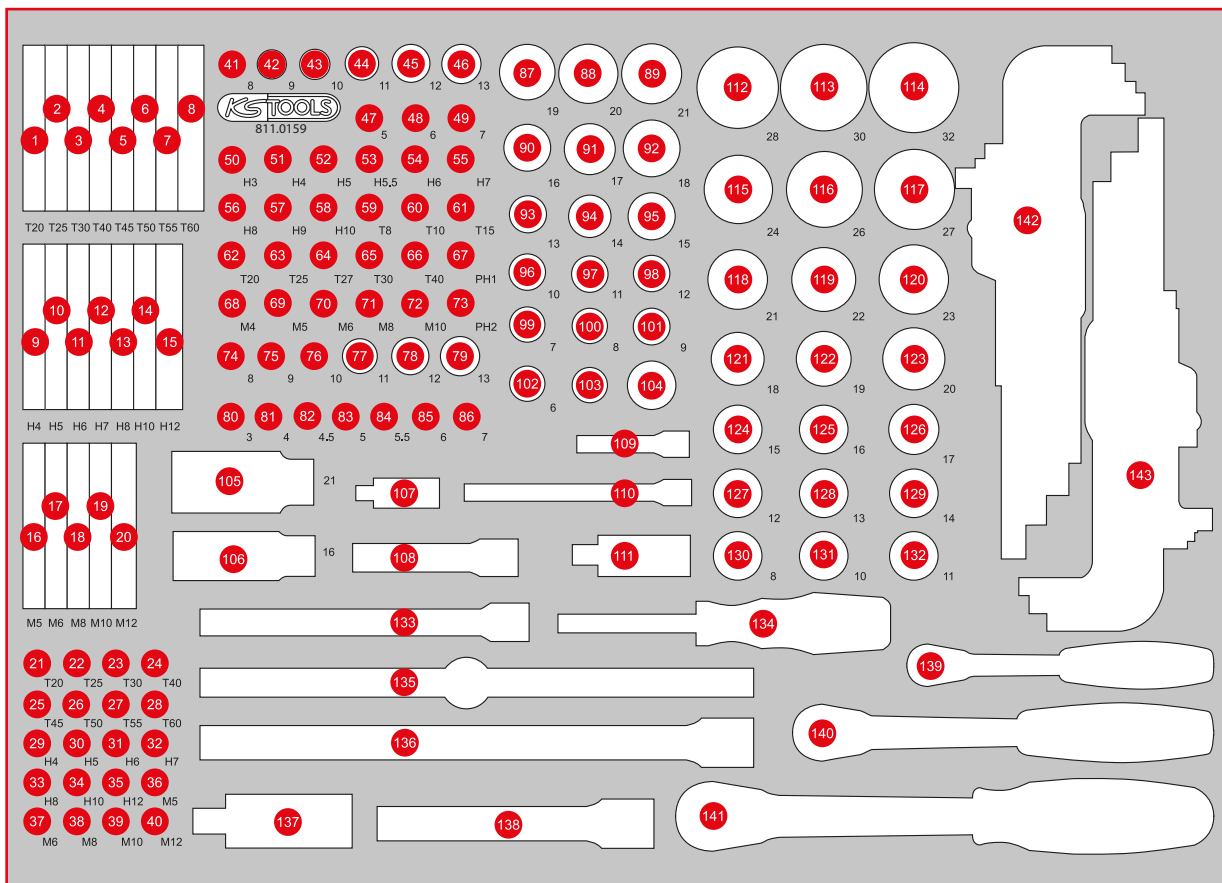

Pos.	Code	Description	pcs	Pos.	Code	Description	pcs	Pos.	Code	Description	pcs
76	917.1410	1/4" Hexagonal socket, 10 mm	1	101	917.3809	3/8" Hexagonal socket, 9 mm	1	126	917.1217	1/2" Hexagonal socket, 17 mm	1
77	917.1411	1/4" Hexagonal socket, 11 mm	1	102	917.3806	3/8" Hexagonal socket, 6 mm	1	127	917.1212	1/2" Hexagonal socket, 12 mm	1
78	917.1412	1/4" Hexagonal socket, 12 mm	1	103	911.4311	3/8" Bit adaptor socket, for bits 10 mm	1	128	917.1213	1/2" Hexagonal socket, 13 mm	1
79	917.1413	1/4" Hexagonal socket, 13 mm	1	105	911.3805	3/8" Spark plug socket, 21 mm	1	129	917.1214	1/2" Hexagonal socket, 14 mm	1
80	917.1445	1/4" Hexagonal socket, 3 mm	1	105	911.4312	1/2" Bit adaptor socket, for bits 10 mm	1	130	917.1340	1/2" Hexagonal socket, 8 mm	1
81	917.1404	1/4" Hexagonal socket, 4 mm	1	106	911.3804	3/8" Spark plug socket, 16 mm	1	131	917.1210	1/2" Hexagonal socket, 10 mm	1
82	917.14045	1/4" Hexagonal socket, 4,5 mm	1	107	911.1450	1/4" Universal joint	1	132	917.1211	1/2" Hexagonal socket, 11 mm	1
83	917.1405	1/4" Hexagonal socket, 5 mm	1	108	911.3801	3/8" Extension with knurling, 75 mm	1	133	911.3802	3/8" Extension with knurling, 150 mm	1
84	917.14055	1/4" Hexagonal socket, 5,5 mm	1	109	911.1423	1/4" Extension with hexagon drive, 50 mm	1	134	911.1434	1/4" Square drive screwdriver, 150 mm	1
85	917.1406	1/4" Hexagonal socket, 6 mm	1	110	911.1424	1/4" Extension with hexagon drive, 100 mm	1	135	911.1204	Sliding T-bar, 1/2", 250 mm	1
86	917.1407	1/4" Hexagonal socket, 7 mm	1	111	911.3850	3/8" Universal joint	1	136	911.1203	1/2" Extensions, 250 mm	1
87	917.3819	3/8" Hexagonal socket, 19 mm	1	112	917.1344	1/2" Hexagonal socket, 28 mm	1	137	911.1250	1/2" Universal joint	1
88	917.3820	3/8" Hexagonal socket, 20 mm	1	113	917.1230	1/2" Hexagonal socket, 30 mm	1	138	911.1202	1/2" Extensions, 125 mm	1
89	917.3821	3/8" Hexagonal socket, 21 mm	1	114	917.1232	1/2" Hexagonal socket, 32 mm	1	139	920.1490	1/4" SlimPOWER Reversible ratchet, 72 teeth	1
90	917.3816	3/8" Hexagonal socket, 16 mm	1	115	917.1224	1/2" Hexagonal socket, 24 mm	1	140	920.3890	3/8" SlimPOWER Reversible ratchet, 72 teeth	1
91	917.3817	3/8" Hexagonal socket, 17 mm	1	116	917.1343	1/2" Hexagonal socket, 26 mm	1	141	920.1290	1/2" SlimPOWER Reversible ratchet, 72 teeth	1
92	917.3818	3/8" Hexagonal socket, 18 mm	1	117	917.1227	1/2" Hexagonal socket, 27 mm	1	142	151.5210	Ball head Torx angled socket wrench set, extra long, 9 pcs	9
93	917.3813	3/8" Hexagonal socket, 13 mm	1	118	917.1221	1/2" Hexagonal socket, 21 mm	1	143	151.4420	Ball ended hexagon key wrench set, extra long, 9 pcs	9
94	917.3814	3/8" Hexagonal socket, 14 mm	1	119	917.1222	1/2" Hexagonal socket, 22 mm	1				
95	917.3815	3/8" Hexagonal socket, 15 mm	1	120	917.1223	1/2" Hexagonal socket, 23 mm	1				
96	917.3810	3/8" Hexagonal socket, 10 mm	1	121	917.1218	1/2" Hexagonal socket, 18 mm	1				
97	917.3811	3/8" Hexagonal socket, 11 mm	1	122	917.1219	1/2" Hexagonal socket, 19 mm	1				
98	917.3812	3/8" Hexagonal socket, 12 mm	1	123	917.1220	1/2" Hexagonal socket, 20 mm	1				
99	917.3807	3/8" Hexagonal socket, 7 mm	1	124	917.1215	1/2" Hexagonal socket, 15 mm	1				
100	917.3808	3/8" Hexagonal socket, 8 mm	1	125	917.1216	1/2" Hexagonal socket, 16 mm	1				

811.1040

M Screw spanner set

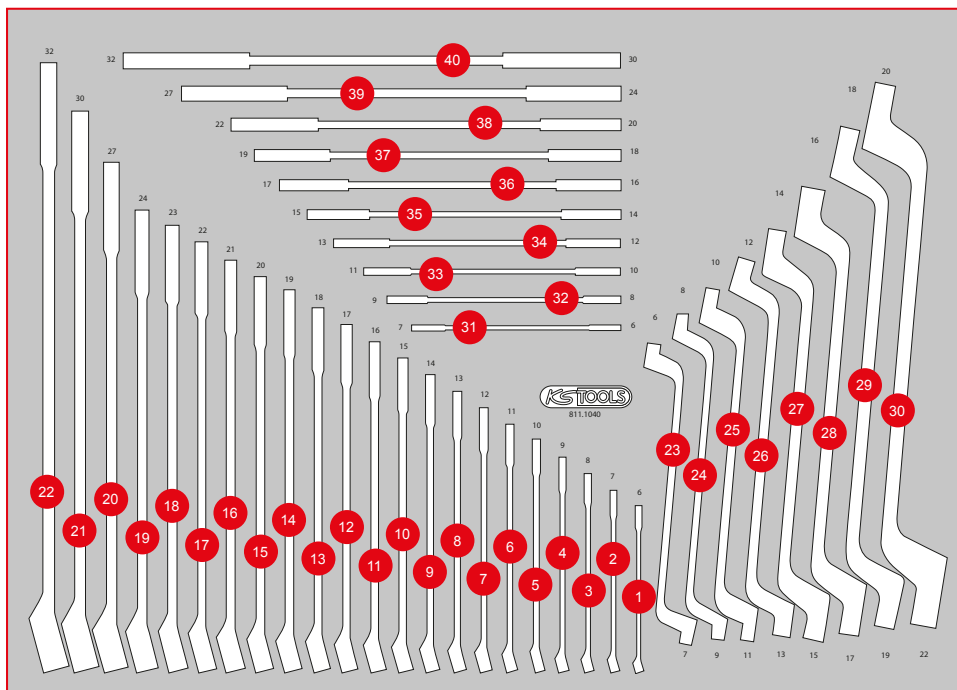
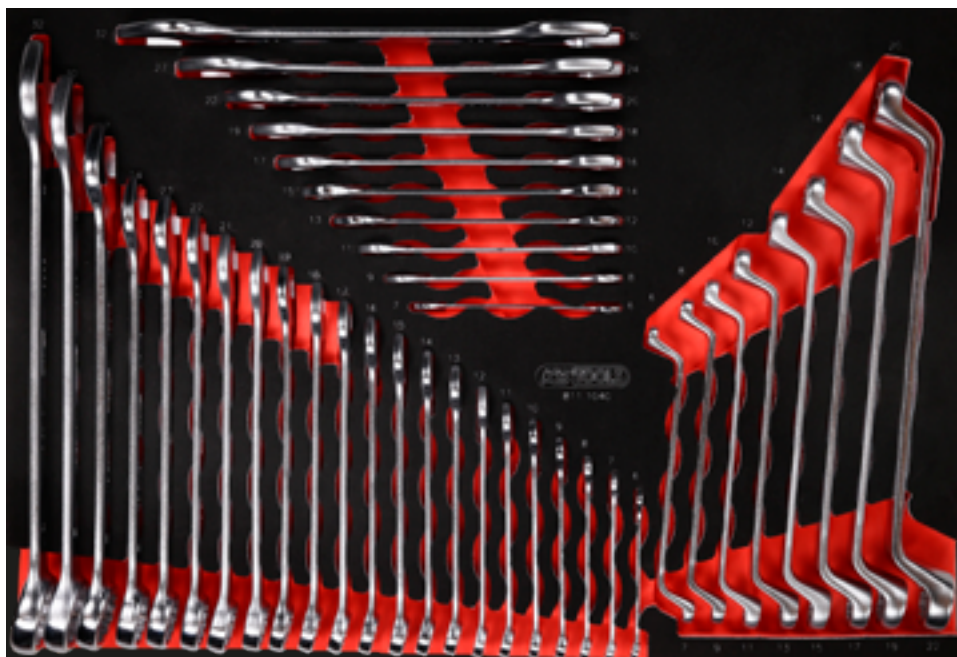

Pos.	Code	Description	pcs
1	517.0606	Combination spanners, offset, 6 mm	1
2	517.0607	Combination spanners, offset, 7 mm	1
3	517.0608	Combination spanners, offset, 8 mm	1
4	517.0609	Combination spanners, offset, 9 mm	1
5	517.0610	Combination spanners, offset, 10 mm	1
6	517.0611	Combination spanners, offset, 11 mm	1
7	517.0612	Combination spanners, offset, 12 mm	1
8	517.0613	Combination spanners, offset, 13 mm	1
9	517.0614	Combination spanners, offset, 14 mm	1
10	517.0615	Combination spanners, offset, 15 mm	1
11	517.0616	Combination spanners, offset, 16 mm	1
12	517.0617	Combination spanners, offset, 17 mm	1
13	517.0618	Combination spanners, offset, 18 mm	1
14	517.0619	Combination spanners, offset, 19 mm	1
15	517.0620	Combination spanners, offset, 20 mm	1
16	517.0621	Combination spanners, offset, 21 mm	1
17	517.0622	Combination spanners, offset, 22 mm	1
18	517.0623	Combination spanners, offset, 23 mm	1
19	517.0624	Combination spanners, offset, 24 mm	1
20	517.0627	Combination spanners, offset, 27 mm	1
21	517.0630	Combination spanners, offset, 30 mm	1
22	517.0632	Combination spanners, offset, 32 mm	1
23	517.0701	Double open ended spanners, 6 x 7 mm	1
24	517.0702	Double open ended spanners, 8 x 9 mm	1
25	517.0704	Double open ended spanners, 10 x 11 mm	1
26	517.0707	Double open ended spanners, 12 x 13 mm	1
27	517.0709	Double open ended spanners, 14 x 15 mm	1
28	517.0710	Double open ended spanners, 16 x 17 mm	1
29	517.0712	Double open ended spanners, 18 x 19 mm	1
30	517.0714	Double open ended spanners, 20 x 22 mm	1
31	517.0716	Double open ended spanners, 24 x 27 mm	1
32	517.0718	Double open ended spanners, 30 x 32 mm	1
33	517.0801	Double ring spanner, offset, 6 x 7 mm	1
34	517.0802	Double ring spanner, offset, 8 x 9 mm	1
35	517.0804	Double ring spanner, offset, 10 x 11 mm	1
36	517.0807	Double ring spanner, offset, 12 x 13 mm	1
37	517.0809	Double ring spanner, offset, 14 x 15 mm	1
38	517.0810	Double ring spanner, offset, 16 x 17 mm	1
39	517.0812	Double ring spanner, offset, 18 x 19 mm	1
40	517.0813	Double ring spanner, offset, 20 x 22 mm	1

811.1022

M T-handle and screwdriver set

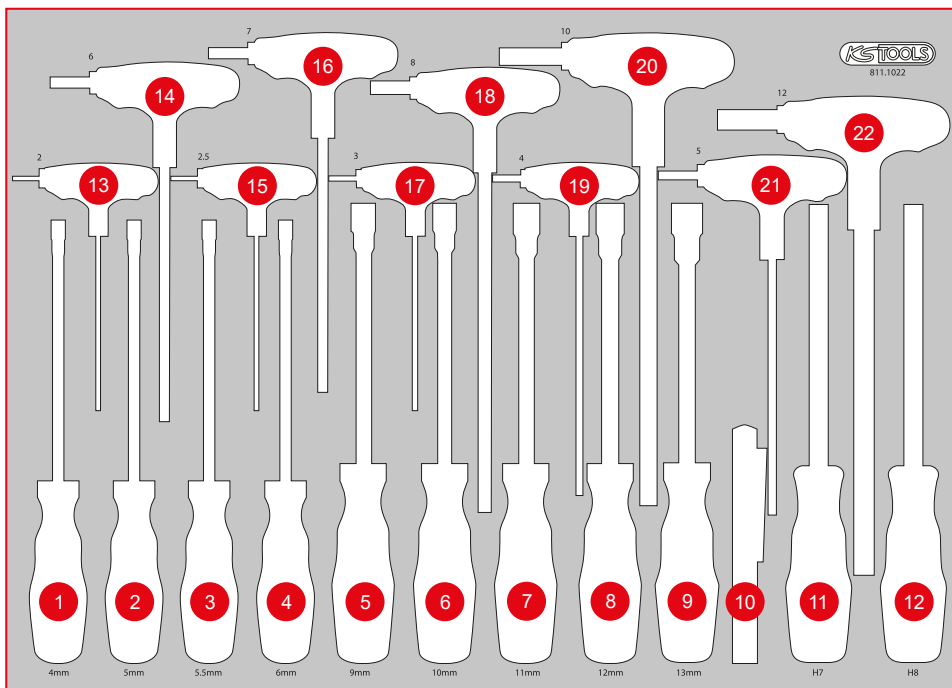

Pos.	Code	Description	pcs
1	159.1201	ERGOTORQUEplus Socket screwdriver, 4 mm	1
2	159.1202	ERGOTORQUEplus Socket screwdriver, 5 mm	1
3	159.1203	ERGOTORQUEplus Socket screwdriver, 5,5 mm	1
4	159.1204	ERGOTORQUEplus Socket screwdriver, 6 mm	1
5	159.1207	ERGOTORQUEplus Socket screwdriver, 9 mm	1
6	159.1208	ERGOTORQUEplus Socket screwdriver, 10 mm	1
7	159.1209	ERGOTORQUEplus Socket screwdriver, 11 mm	1
8	159.1210	ERGOTORQUEplus Socket screwdriver, 12 mm	1
9	159.1211	ERGOTORQUEplus Socket screwdriver, 13 mm	1
10	150.4370	perfectLight torch 85 lumen	1
11	159.1127	ERGOTORQUEplus Socket screwdriver, 7 mm	1
12	159.2128	ERGOTORQUEplus Socket screwdriver, 8 mm	1
13	151.8130	T-handle ball ended hexagon key wrench, 2 mm	1
14	151.8135	T-handle ball ended hexagon key wrench, 6 mm	1
15	151.8131	T-handle ball ended hexagon key wrench, 2,5 mm	1
16	151.8136	T-handle ball ended hexagon key wrench, 7 mm	1
17	151.8132	T-handle ball ended hexagon key wrench, 3 mm	1
18	151.8137	T-handle ball ended hexagon key wrench, 8 mm	1
19	151.8133	T-handle ball ended hexagon key wrench, 4 mm	1
20	151.8138	T-handle ball ended hexagon key wrench, 10 mm	1
21	151.8134	T-handle ball ended hexagon key wrench, 5 mm	1
22	151.8139	T-handle ball ended hexagon key wrench, 12 mm	1

811.0017

M Pliers, Hammer and chisel set



Pos.	Code	Description	pcs
1	157.0205	Round file, form F, cut 2, 200 mm	1
2	157.0005	Flat file, form B, cut 2, 200 mm	1
3	157.0405	Tri-bastard file, form C, cut 2, 200 mm	1
4	157.0105	Halfround file, form E, cut 2, 20 mm	1
5	156.0241	Flat chisel, octagon, 20 mm	1
6	156.0254	Flat chisel, octagon, 18 mm	1
7	201.2335	Steel wire brake saddle brush, 2-row, straight	1
8	115.1012	ERGOTORQUE diagonal side cutter, 160 mm	1
9	115.1021	ERGOTORQUE combination pliers, 180 mm	1
10	300.0114	Tape measure with locking device and belt clip, black red, 5 m, 19 mm	1
11	142.1402	Fitters Hammer, fibreglas handle, 400 g	1
12	115.1019	ERGOTORQUE bent nose pliers serrated, 210 mm	1
13	115.1024	ERGOTORQUE long nose pliers serrated cutter, 200 mm	1
14	115.2010	Water pump pliers, 240 mm	1
15	115.1033	Self grip wrench, 220 mm	1
16	142.5101	Club Hammer, fibreglas handle, 1000 g	1
17	550.1001	2in1 Telescopic solenoid holder with washer jet cleaning and setting tool, 150-675 mm	1

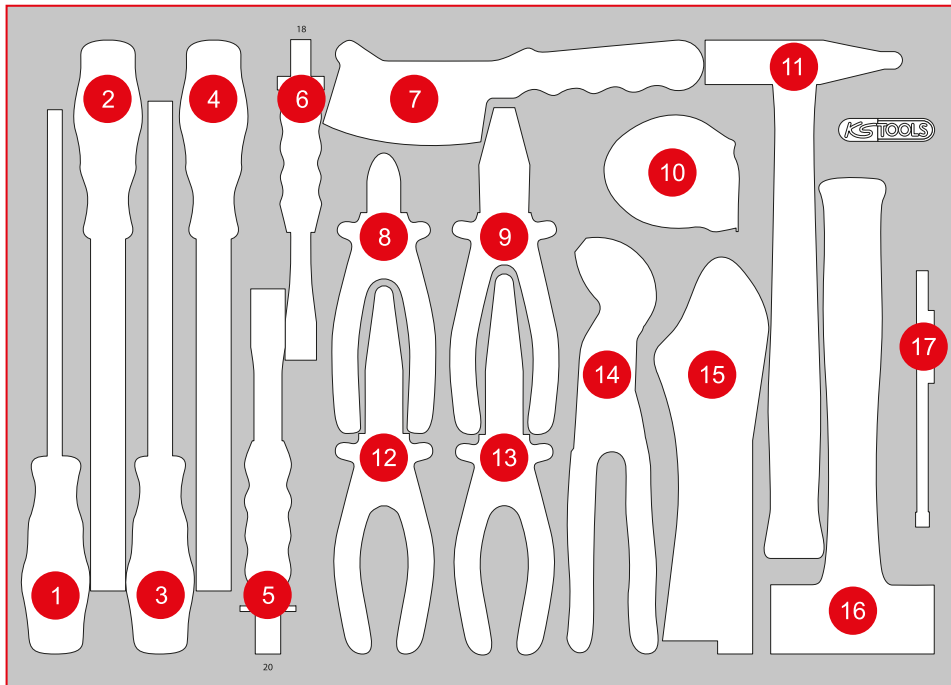

P10

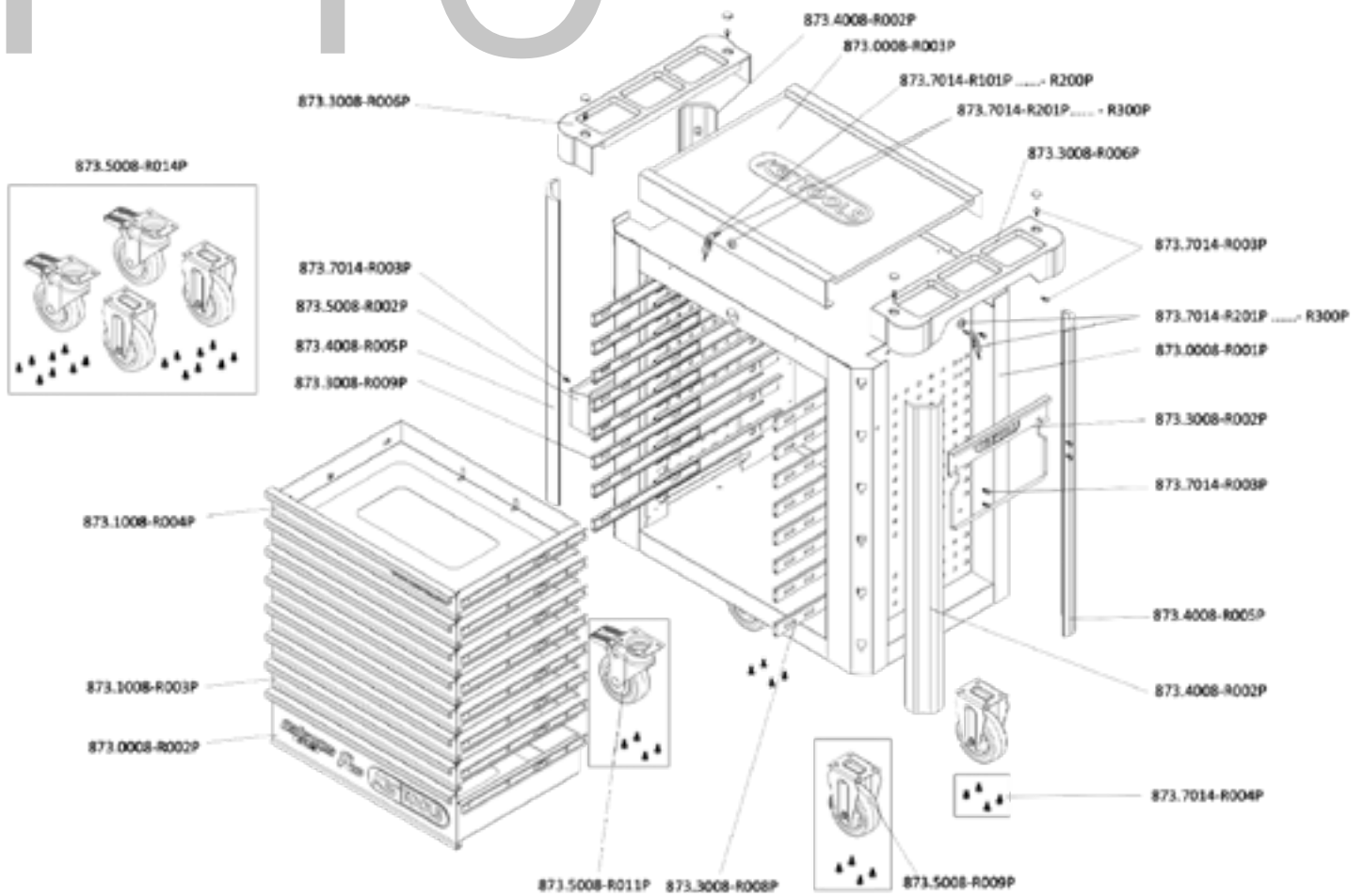

INDIVIDUAL PARTS LIST

Item No.	Description	Amount
873.7014-R101P...	Replacement key for PERFORMANCEplus workshop trolley lock number xyz	2
873.7014-R201P...	Lock with 2 keys for PERFORMANCEplus workshop trolley lock number xyz	2
873.0008-R001P	Body with handle	1
873.0008-R002P	Compartment with logo and ball-bearing guide, 568x398x145 mm	1
873.0008-R003P	Stainless steel worktop	1
873.1008-R003P	Compartment with ball-bearing guide, for workshop trolley P10/P10TC/P15, 568x398x65 mm	6
873.1008-R004P	Compartment with website and ball-bearing guide, for workshop trolley P10/P15, 568x398x65 mm	1
873.3008-R002P	Paper roll holder for PERFORMANCEplus workshop trolley	1
873.3008-R006P	Storage for work surface	2
873.3008-R008P	Full extension (with ball-bearing guide) with automatic retraction	8
873.3008-R009P	Full extension (with ball-bearing guide) with automatic retraction	8
873.4008-R002P	Plastic bumpers	2
873.4008-R005P	Plastic bumpers	2
873.5008-R002P	Can holder for PERFORMANCEplus workshop trolley	1
873.5008-R009P	Fixed castors for PERFORMANCEplus workshop trolley, incl. screws	2
873.5008-R011P	Swivel castors with brakes, for PERFORMANCEplus workshop trolley, incl. screws	2
873.5008-R014P	Roller set for PERFORMANCEplus workshop trolley, incl. screws	1
873.7014-R003P	M6x12 screws for PERFORMANCEplus workshop trolley accessories	14
873.7014-R004P	M8 screws for PERFORMANCEplus workshop trolley rollers (16 pcs.)	1



873.7014-R101P...R200P
Replacement key for lock number xyz



873.7014-R201P...R300P
Lock with 2 keys for lock number xyz



873.3008-R008P
Full extension (with ball-bearing guide) with automatic retraction, right



873.3008-R009P
Full extension (with ball-bearing guide) with automatic retraction, left



873.5008-R009P
Fixed castors, incl. screws



873.5008-R011P
Swivel castors with brakes, incl. screws



873.5008-R014P
Roller set, incl. screws



873.0008-R003P
Stainless steel work surface



873.3008-R006P
Storage for work surface, including screw cover, usable on both sides



873.1008-R004P
Compartment with website and ball-bearing guide, 568x398x65 mm



873.1008-R003P
Compartment with ball-bearing guide, 568x398x65 mm



873.0008-R002P
Compartment with logo and ball-bearing guide, 568x398x145 mm



873.5008-R002P
Can holder, 310 mm



873.3008-R002P
Paper roll holder, 320 mm



873.4008-R005P
Plastic bumpers, front left, back right



873.4008-R002P
Plastic bumpers, front right, back left



873.7014-R004P
M8 screws (16 pcs.)



873.7014-R003P
M6x12 screw (1 pcs.)



873.0008-R001P
Body with handle



A thousand great parts for tough guys!

