

P10

workshop tool trolley
with 180 tools for 4 drawers
810.4180

Workshop trolley P10

with 8 compartments

873.0008

THE ENTRY MODEL TO SATISFY HIGH STANDARDS



P10

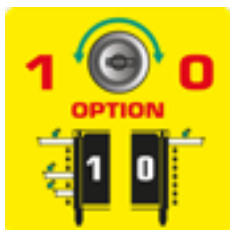

DUO Lock Brilliant locking system



Eight drawers each load capacity up to 50 kg



Stable **ball bearing**



Stainless steel surface

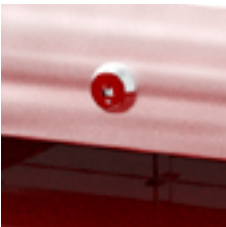

Lock lockable



Anti-static castors with brakes



Integrated **corner protection**



Paper roll holder included



Can holder included

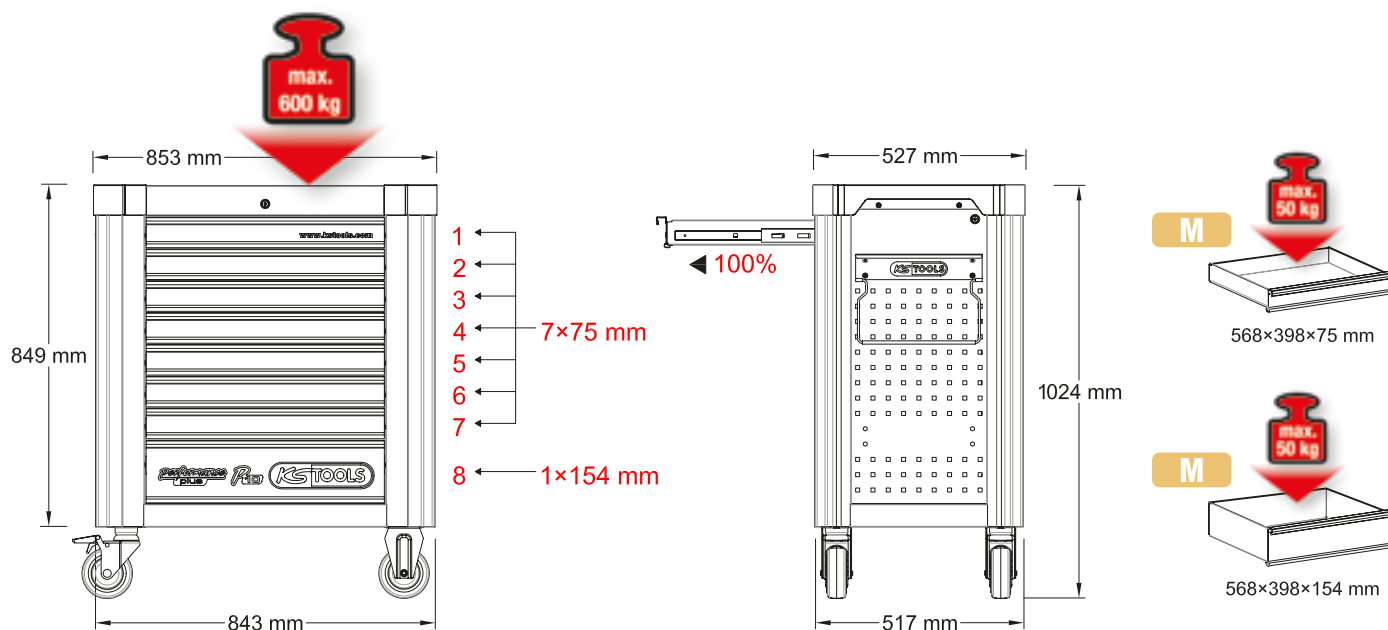

P10 workshop tool trolley set with 180 tools for 4 drawers

810.4180

180

M

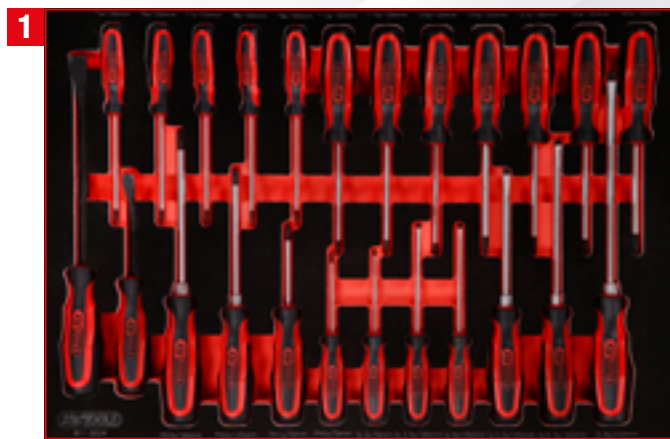

Screwdriver set in foam insert

811.0024

24

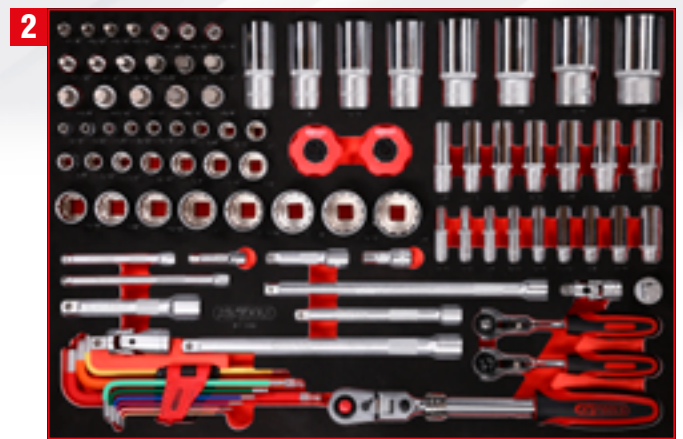

1/4" + 3/8" + 1/2" socket spanner set in foam insert

811.0092

92



Screw spanner set in foam insert

811.0031

31



Pliers, hammer and chisel set in foam insert

811.0033

33

811.0024

M Screwdriver set

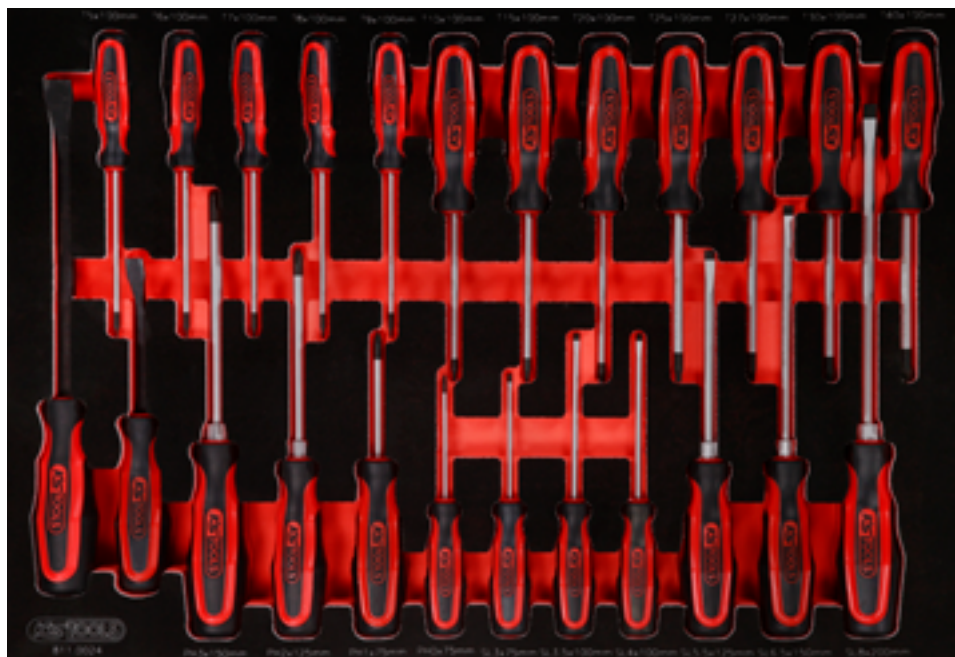

| Pos. | Code | Description | pcs |
|------|----------|---|-----|
| 1 | 911.8102 | Pry bar, 15 x 185 mm | 1 |
| 2 | 911.8101 | Pry bar, 11 x 115 mm | 1 |
| 3 | 159.1133 | ERGOTORQUEplus screwdriver, Torx, T5 | 1 |
| 4 | 159.1134 | ERGOTORQUEplus screwdriver, Torx, T6 | 1 |
| 5 | 159.1135 | ERGOTORQUEplus screwdriver, Torx, T7 | 1 |
| 6 | 159.1030 | ERGOTORQUEplus screwdriver, Torx, T8 | 1 |
| 7 | 159.1031 | ERGOTORQUEplus screwdriver, Torx, T9 | 1 |
| 8 | 159.1032 | ERGOTORQUEplus screwdriver, Torx, T10 | 1 |
| 9 | 159.1033 | ERGOTORQUEplus screwdriver, Torx, T15 | 1 |
| 10 | 159.1034 | ERGOTORQUEplus screwdriver, Torx, T20 | 1 |
| 11 | 159.1035 | ERGOTORQUEplus screwdriver, Torx, T25 | 1 |
| 12 | 159.1036 | ERGOTORQUEplus screwdriver, Torx, T27 | 1 |
| 13 | 159.1037 | ERGOTORQUEplus screwdriver, Torx, T30 | 1 |
| 14 | 159.1038 | ERGOTORQUEplus screwdriver, Torx, T40 | 1 |
| 15 | 159.1024 | ERGOTORQUEplus screwdriver, Torx, PH3, 265 mm | 1 |
| 16 | 159.1022 | ERGOTORQUEplus screwdriver, Torx, PH2, 230 mm | 1 |
| 17 | 159.1020 | ERGOTORQUEplus screwdriver, Torx, PH1, 180 mm | 1 |
| 18 | 159.1027 | ERGOTORQUEplus screwdriver, Torx, PH0, 155 mm | 1 |
| 19 | 159.1002 | ERGOTORQUEplus screwdriver for slotted screws, 3 mm, 155 mm | 1 |
| 20 | 159.1112 | ERGOTORQUEplus screwdriver for slotted screws, 3,5 mm, 180 mm | 1 |
| 21 | 159.1004 | ERGOTORQUEplus screwdriver for slotted screws, 4 mm, 180 mm | 1 |
| 22 | 159.1006 | ERGOTORQUEplus screwdriver for slotted screws, 5,5 mm, 230 mm | 1 |
| 23 | 159.1009 | ERGOTORQUEplus screwdriver for slotted screws, 6,5 mm, 255 mm | 1 |
| 24 | 159.1011 | ERGOTORQUEplus screwdriver for slotted screws, 8 mm, 315 mm | 1 |

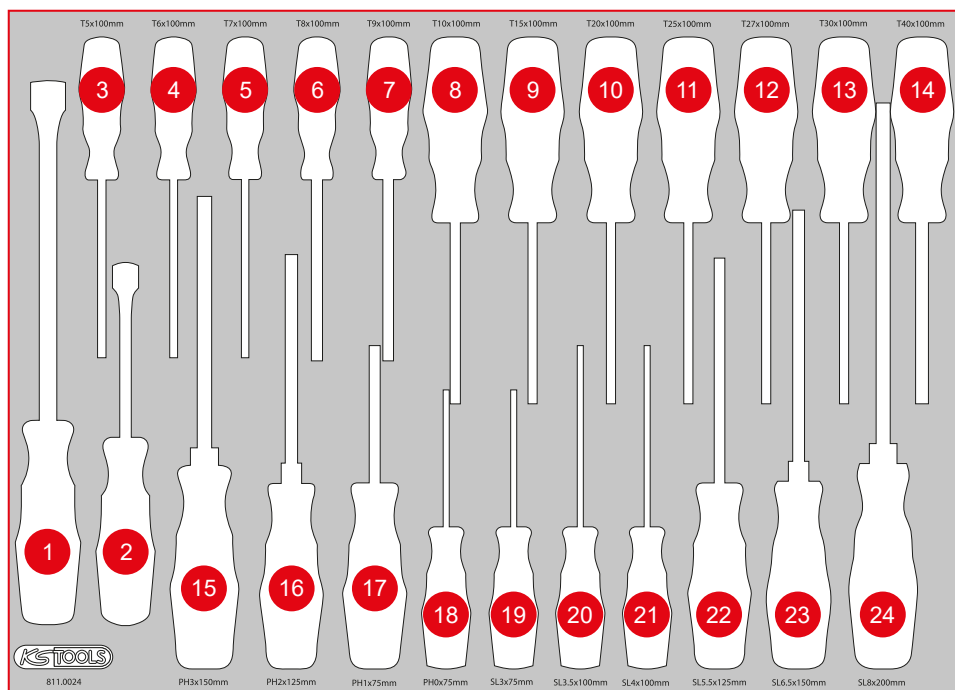

811.0092

M 1/4" + 3/8" + 1/2" Socket spanner set



| Pos. | Code | Description | pcs | Pos. | Code | Description | pcs | Pos. | Code | Description | pcs |
|------|----------|--|-----|------|----------|--|-----|------|----------|---------------------------------|-----|
| 1 | 914.1220 | 1/2" SlimPOWER Telescopic reversible ratchet, 72 teeth | 1 | 13 | 911.1202 | 1/2" Extensions, 125 mm | 1 | 28 | 911.4000 | 3/8" 12 Point socket, 1/2" | 1 |
| 2 | 914.3815 | 3/8" MODIFIX mini T-handle swivel head ratchet, 72 teeth, 0° + 90° | 1 | 14 | 911.1203 | 1/2" Extensions, 250 mm | 1 | 29 | 911.4001 | 3/8" 12 Point socket, 9/16" | 1 |
| 3 | 914.1405 | 1/4" MODIFIX mini T-handle swivel head ratchet, 72 teeth | 1 | 15 | 911.3850 | 3/8" Universal joint | 1 | 30 | 911.4003 | 3/8" 12 Point socket, 5/8" | 1 |
| 4 | 151.4520 | KBall ended hexagon key wrench set, extra long, 9 pcs, imperial | 9 | 16 | 911.3826 | 3/8" Sliding / reducing adaptor, 1/2"F x 3/8"M | 1 | 31 | 911.4004 | 3/8" 12 Point socket, 11/16" | 1 |
| 5 | 911.1250 | 1/2" Universal joint | 1 | 17 | 917.1474 | 1/4" 12 Point socket, 3/16" | 1 | 32 | 911.4005 | 3/8" 12 Point socket, 3/4" | 1 |
| 6 | 911.1423 | 1/4" Extension with hexagon drive, 50 mm | 1 | 18 | 917.1475 | 1/4" 12 Point socket, 7/32" | 1 | 33 | 917.1380 | 1/2" 12 Point socket, 13/16" | 1 |
| 7 | 911.1424 | 1/4" Extension with hexagon drive, 100 mm | 1 | 19 | 917.1476 | 1/4" 12 Point socket, 1/4" | 1 | 34 | 917.1381 | 1/2" 12 Point socket, 7/8" | 1 |
| 8 | 911.1451 | 1/4" Extension with hexagon drive, 150 mm | 1 | 20 | 917.1477 | 1/4" 12 Point socket, 9/32" | 1 | 35 | 917.1382 | 1/2" 12 Point socket, 15/16" | 1 |
| 9 | 911.3852 | 3/8" Extension with knurling, 45 mm | 1 | 21 | 917.1478 | 1/4" 12 Point socket, 5/16" | 1 | 36 | 917.1383 | 1/2" 12 Point socket, 1" | 1 |
| 10 | 911.3801 | 3/8" Extension with knurling, 75 mm | 1 | 22 | 917.1479 | 1/4" 12 Point socket, 11/32" | 1 | 37 | 917.1384 | 1/2" 12 Point socket, 1.1/16" | 1 |
| 11 | 911.3802 | 3/8" Extension with knurling, 150 mm | 1 | 23 | 917.1480 | 1/4" 12 Point socket, 3/8" | 1 | 38 | 917.1385 | 1/2" 12 Point socket, 1.1/8" | 1 |
| 12 | 911.3803 | 3/8" Extension with knurling, 250 mm | 1 | 24 | 917.1481 | 1/4" 12 Point socket, 7/16" | 1 | 39 | 917.1386 | 1/2" 12 Point socket, 1.3/16" | 1 |
| | | | | 25 | 917.1482 | 1/4" 12 Point socket, 1/2" | 1 | 40 | 917.1387 | 1/2" 12 Point socket, 1.1/4" | 1 |
| | | | | 26 | 917.3851 | 3/8" 12 Point socket, 3/8" | 1 | 41 | 917.1565 | 1/4" 12 Point socket deep 3/16" | 1 |
| | | | | 27 | 917.3852 | 3/8" 12 Point socket, 7/16" | 1 | 42 | 917.1566 | 1/4" 12 Point socket deep 7/32" | 1 |

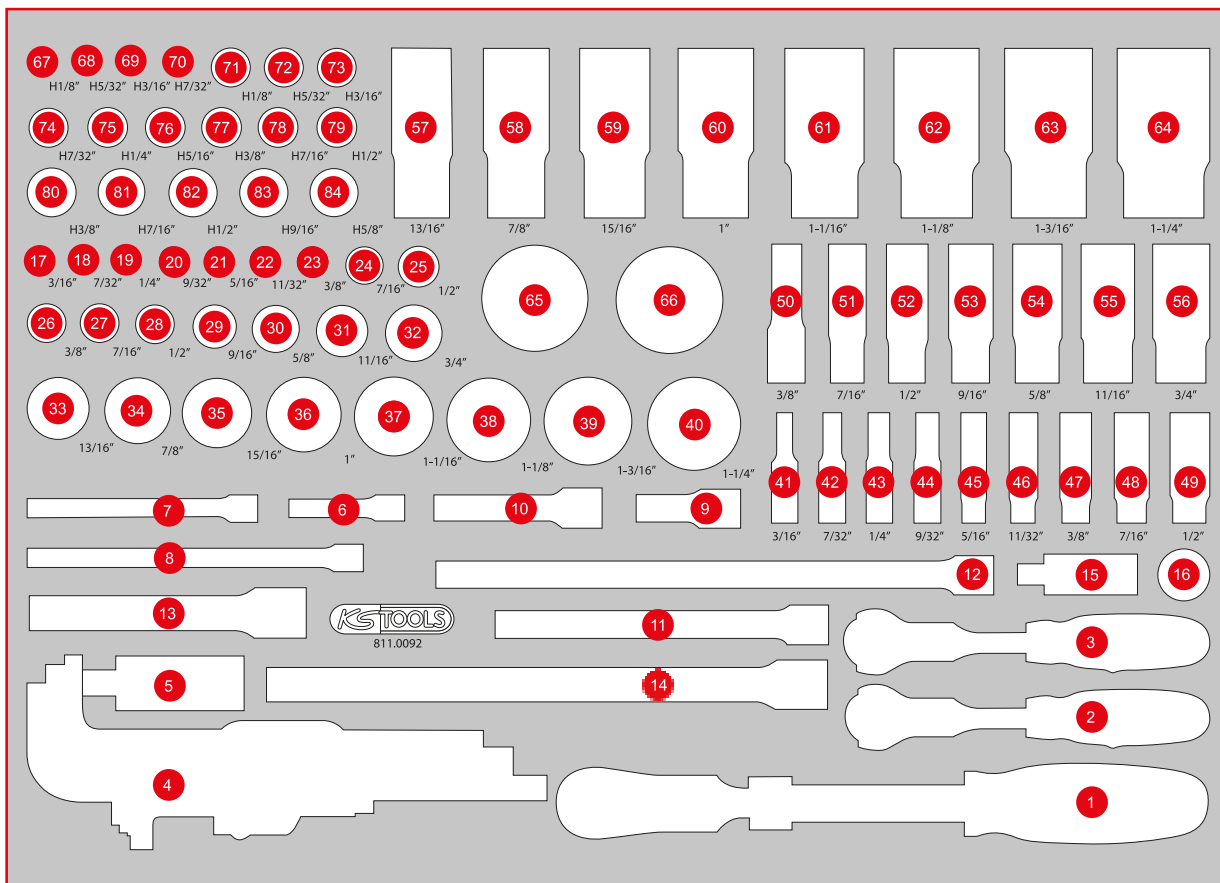

| Pos. | Code | Description | pcs | Pos. | Code | Description | pcs | Pos. | Code | Description | pcs |
|------|----------|------------------------------------|-----|------|----------|--|-----|------|----------|---------------------------------------|-----|
| 43 | 917.1567 | 1/4" 12 Point socket deep 1/4" | 1 | 58 | 917.1283 | 1/2" 12 Point socket, deep, 7/8" | 1 | 73 | 917.3963 | 3/8" Bit socket hexagon, 3/16" | 1 |
| 44 | 917.1568 | 1/4" 12 Point socket deep 9/32" | 1 | 59 | 917.1284 | 1/2" 12 Point socket, deep, 15/16" | 1 | 74 | 917.3968 | 3/8" Bit socket hexagon, 7/32" | 1 |
| 45 | 917.1569 | 1/4" 12 Point socket deep 5/16" | 1 | 60 | 917.1289 | 1/2" 12 Point socket, deep, 1" | 1 | 75 | 917.3964 | 3/8" Bit socket hexagon, 1/4" | 1 |
| 46 | 917.1570 | 1/4" 12 Point socket deep 11/32" | 1 | 61 | 917.5348 | 1/2" 12 Point socket, deep, 1.1/16" | 1 | 76 | 917.3965 | 3/8" Bit socket hexagon, 5/16" | 1 |
| 47 | 917.1571 | 1/4" 12 Point socket deep 3/8" | 1 | 62 | 917.5349 | 1/2" 12 Point socket, deep, 1.1/8" | 1 | 77 | 917.3966 | 3/8" Bit socket hexagon, 3/8" | 1 |
| 48 | 917.1572 | 1/4" 12 Point socket deep 7/16" | 1 | 63 | 917.5353 | 1/2" 12 Point socket, deep, 1.3/16" | 1 | 78 | 917.3993 | 3/8" Bit socket hexagon, 7/16" | 1 |
| 49 | 917.1573 | 1/4" 12 Point socket deep 1/2" | 1 | 64 | 917.5351 | 1/2" 12 Point socket, deep, 1.1/4" | 1 | 79 | 917.3994 | 3/8" Bit socket hexagon, 1/2" | 1 |
| 50 | 917.3983 | 3/8" 12 Point socket, deep, 3/8" | 1 | 65 | 914.3810 | Mini hand reversible ratchet, 3/8", 72 teeth | 1 | 80 | 917.1321 | 1/2" Bit socket hexagon, short, 3/8" | 1 |
| 51 | 917.3984 | 3/8" 12 Point socket, deep, 7/16" | 1 | 66 | 914.1410 | Mini hand reversible ratchet, 1/4", 72 teeth | 1 | 81 | 911.5387 | 1/2" Bit socket hexagon, short, 7/16" | 1 |
| 52 | 917.3985 | 3/8" 12 Point socket, deep, 1/2" | 1 | 67 | 917.1440 | 1/4" Bit socket hexagon, 1/8" | 1 | 82 | 917.1322 | 1/2" Bit socket hexagon, short, 1/2" | 1 |
| 53 | 917.3986 | 3/8" 12 Point socket, deep, 9/16" | 1 | 68 | 917.1441 | 1/4" Bit socket hexagon, 5/32" | 1 | 83 | 917.1323 | 1/2" Bit socket hexagon, short, 9/16" | 1 |
| 54 | 917.3987 | 3/8" 12 Point socket, deep, 5/8" | 1 | 69 | 917.1442 | 1/4" Bit socket hexagon, 3/16" | 1 | 84 | 917.1324 | 1/2" Bit socket hexagon, short, 5/8" | 1 |
| 55 | 917.3988 | 3/8" 12 Point socket, deep, 11/16" | 1 | 70 | 917.1443 | 1/4" Bit socket hexagon, 7/32" | 1 | | | | |
| 56 | 917.3989 | 3/8" 12 Point socket, deep, 3/4" | 1 | 71 | 917.3967 | 3/8" Bit socket hexagon, 1/8" | 1 | | | | |
| 57 | 917.1282 | 1/2" 12 Point socket, deep, 13/16" | 1 | 72 | 917.3962 | 3/8" Bit socket hexagon, 5/32" | 1 | | | | |

M Screw spanner set



| Pos. | Code | Description | pcs |
|------|----------|---|-----|
| 1 | 517.0895 | Double ring spanner, offset, 15/16 x 1" | 1 |
| 2 | 517.0894 | Double ring spanner, offset, 13/16 x 7/8" | 1 |
| 3 | 517.0889 | Double ring spanner, offset, 11/16 x 3/4" | 1 |
| 4 | 517.0887 | Double ring spanner, offset, 9/16 x 5/8" | 1 |
| 5 | 517.0885 | Double ring spanner, offset, 1/2 x 9/16" | 1 |
| 6 | 517.0883 | Double ring spanner, offset, 3/8 x 7/16" | 1 |
| 7 | 517.0881 | Double ring spanner, offset, 1/4 x 5/16" | 1 |
| 8 | 517.9268 | CLASSIC flare nut spanner, 5/8" x 11/16" | 1 |
| 9 | 517.9267 | CLASSIC flare nut spanner, 1/2" x 9/16" | 1 |
| 10 | 517.9266 | CLASSIC flare nut spanner, 3/8" x 7/16" | 1 |
| 11 | 517.9265 | CLASSIC flare nut spanner, 1/4" x 5/16" | 1 |
| 12 | 517.0781 | Double open ended spanners, 1/4 x 5/16" | 1 |
| 13 | 517.0783 | Double open ended spanners, 3/8 x 7/16" | 1 |
| 14 | 517.0785 | Double open ended spanners, 1/2 x 9/16" | 1 |
| 15 | 517.0788 | Double open ended spanners, 5/8 x 11/16" | 1 |
| 16 | 517.0789 | Double open ended spanners, 11/16 x 3/4" | 1 |
| 17 | 517.0794 | Double open ended spanners, 13/16 x 7/8" | 1 |
| 18 | 517.0795 | Double open ended spanners, 15/16 x 1" | 1 |
| 19 | 517.0774 | Double open ended spanners, 1.1/8" x 1.1/4" | 1 |
| 20 | 517.1901 | Combination spanners, offset, 1/4" | 1 |
| 21 | 517.1902 | Combination spanners, offset, 5/16" | 1 |
| 22 | 517.1903 | Combination spanners, offset, 3/8" | 1 |
| 23 | 517.1904 | Combination spanners, offset, 7/16" | 1 |
| 24 | 517.1951 | Combination spanners, offset, 1/2" | 1 |
| 25 | 517.1906 | Combination spanners, offset, 9/16" | 1 |
| 26 | 517.1907 | Combination spanners, offset, 5/8" | 1 |
| 27 | 517.1908 | Combination spanners, offset, 11/16" | 1 |
| 28 | 517.1909 | Combination spanners, offset, 3/4" | 1 |
| 29 | 517.1912 | Combination spanners, offset, 13/16" | 1 |
| 30 | 517.1913 | Combination spanners, offset, 7/8" | 1 |
| 31 | 517.1914 | Combination spanners, offset, 15/16" | 1 |

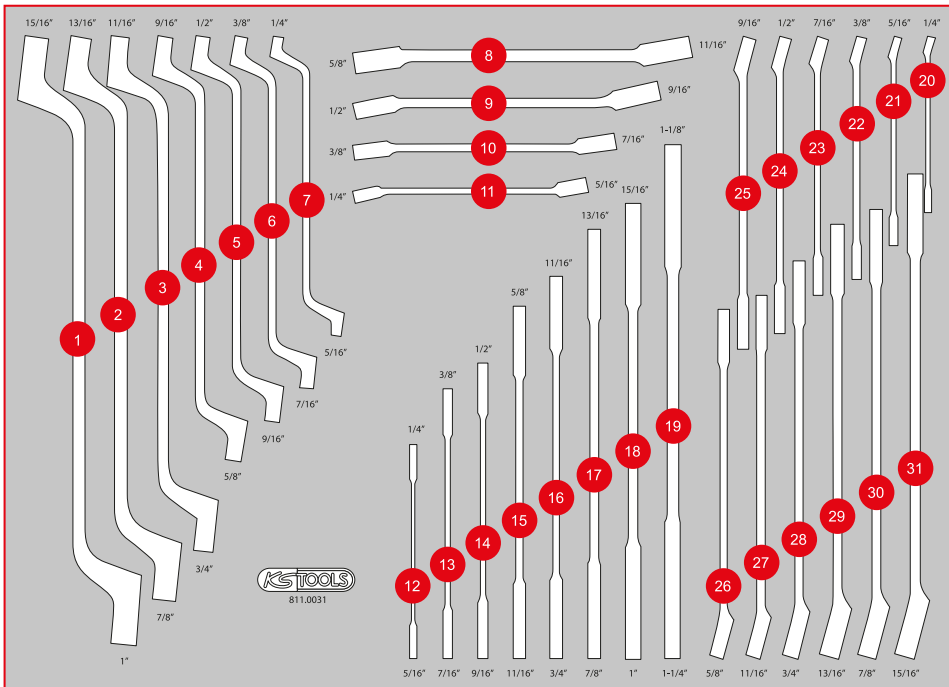

811.0033

M Pliers, Hammer and chisel set

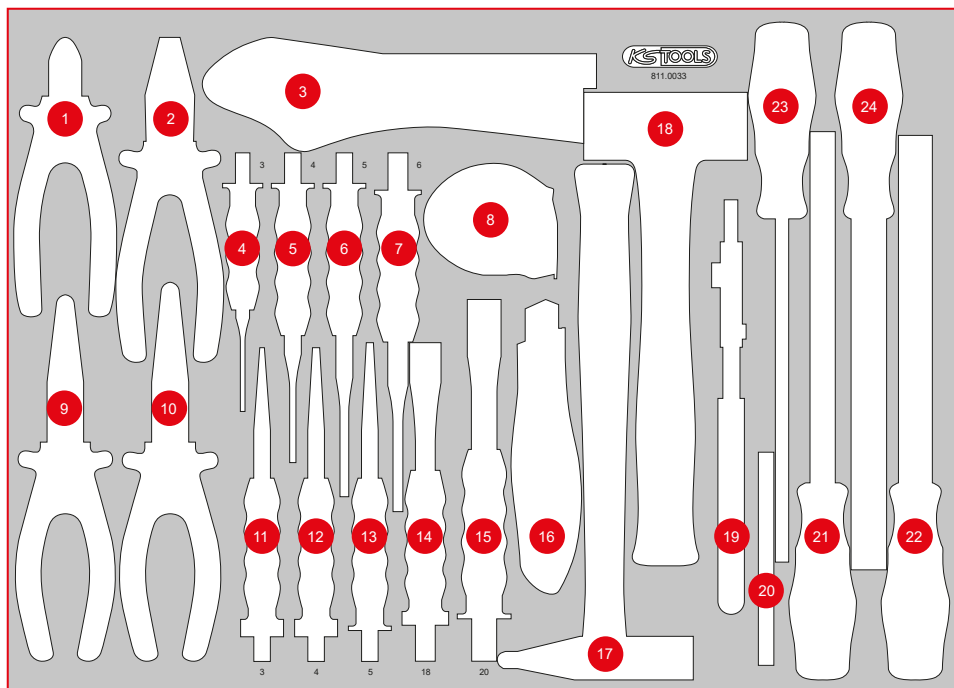

| Pos. | Code | Description | pcs |
|------|----------|---|-----|
| 1 | 115.1012 | ERGOTORQUE diagonal side cutter, 160 mm | 1 |
| 2 | 115.1021 | ERGOTORQUE combination pliers, 180 mm | 1 |
| 3 | 115.1033 | Self grip wrench, 220 mm | 1 |
| 4 | 156.0231 | Pin punch, Ø 3 mm, cylindrical shaft | 1 |
| 5 | 156.0232 | Pin punch, Ø 4 mm, cylindrical shaft | 1 |
| 6 | 156.0233 | Pin punch, Ø 5 mm, cylindrical shaft | 1 |
| 7 | 156.0234 | Pin punch, Ø 6 mm, cylindrical shaft | 1 |
| 8 | 300.0114 | Tape measure with locking device and belt clip, black red, 5 m, 19 mm | 1 |
| 9 | 115.1019 | ERGOTORQUE bent nose pliers serrated, 210 mm | 1 |
| 10 | 115.1024 | ERGOTORQUE long nose pliers serrated cutter, 200 mm | 1 |
| 11 | 156.0237 | Punch, Ø 3 mm, conical | 1 |
| 12 | 156.0238 | Punch, Ø 4 mm, conical | 1 |
| 13 | 156.0244 | Punch, Ø 5 mm, conical | 1 |
| 14 | 156.0254 | Flat chisel, octagon, 18 mm | 1 |
| 15 | 156.0241 | Flat chisel, octagon, 20 mm | 1 |
| 16 | 907.2135 | Universal snap off blade knife 18 mm | 1 |
| 17 | 142.1402 | Fitters Hammer, fibreglas handle, 400 g | 1 |
| 18 | 142.5101 | Club Hammer, fibreglas handle, 1000 g | 1 |
| 19 | 115.2010 | Water pump pliers, 240 mm | 1 |
| 20 | 907.2166 | Snap off blades 0,5 x 1,8 x 100 mm, dispenser with 10 pieces | 10 |
| 21 | 157.0405 | Tri-bastard file, form C, cut 2, 200 mm | 1 |
| 22 | 157.0105 | Halfround file, form E, cut 2, 20 mm | 1 |
| 23 | 157.0205 | Round file, form F, cut 2, 200 mm | 1 |
| 24 | 157.0005 | Flat file, form B, cut 2, 200 mm | 1 |

P10

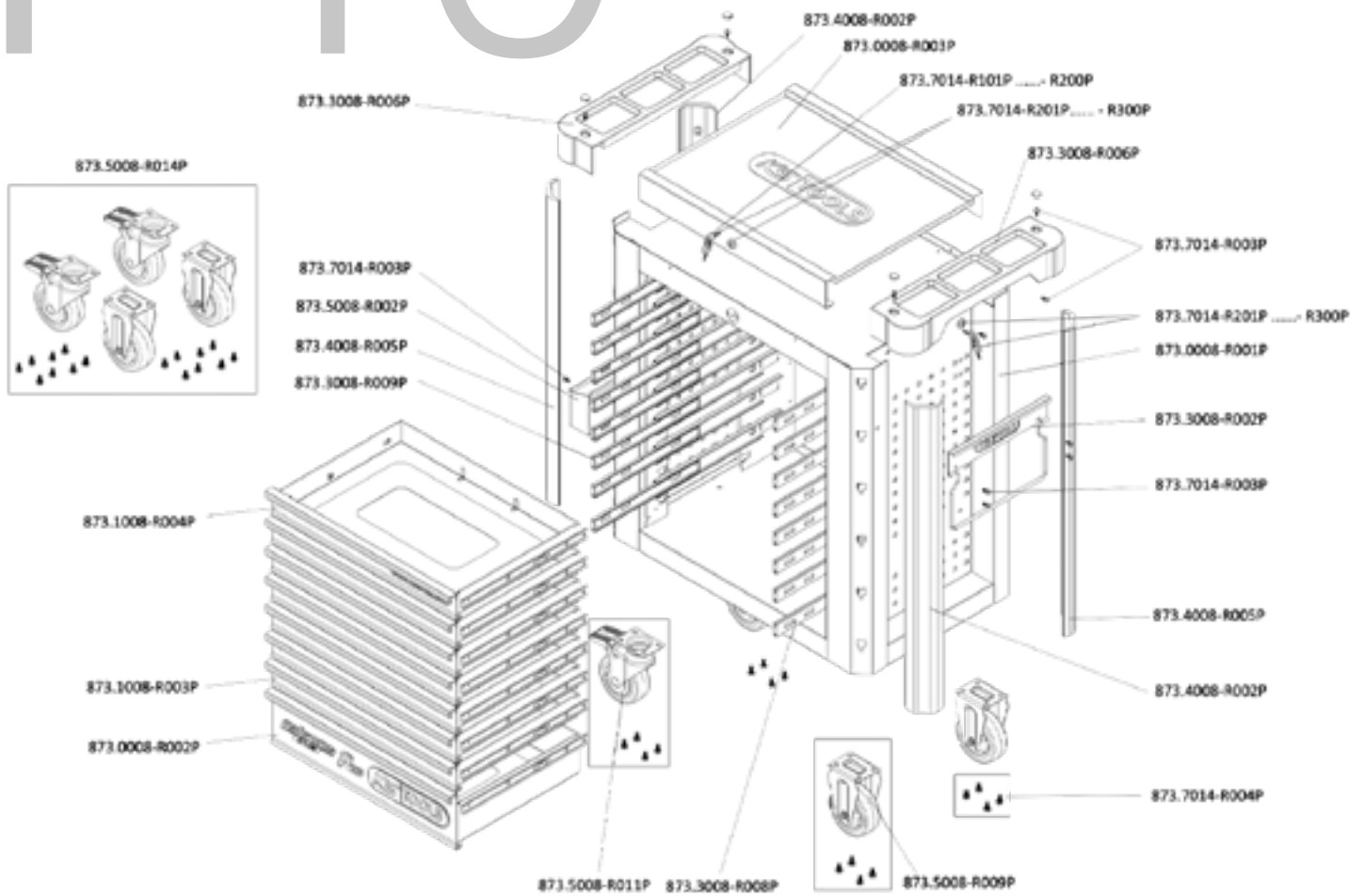

INDIVIDUAL PARTS LIST

| Item No. | Description | Amount |
|-------------------|--|--------|
| 873.7014-R101P... | Replacement key for PERFORMANCEplus workshop trolley lock number xyz | 2 |
| 873.7014-R201P... | Lock with 2 keys for PERFORMANCEplus workshop trolley lock number xyz | 2 |
| 873.0008-R001P | Body with handle | 1 |
| 873.0008-R002P | Compartment with logo and ball-bearing guide, 568x398x145 mm | 1 |
| 873.0008-R003P | Stainless steel worktop | 1 |
| 873.1008-R003P | Compartment with ball-bearing guide, for workshop trolley P10/P10TC/P15, 568x398x65 mm | 6 |
| 873.1008-R004P | Compartment with website and ball-bearing guide, for workshop trolley P10/P15, 568x398x65 mm | 1 |
| 873.3008-R002P | Paper roll holder for PERFORMANCEplus workshop trolley | 1 |
| 873.3008-R006P | Storage for work surface | 2 |
| 873.3008-R008P | Full extension (with ball-bearing guide) with automatic retraction | 8 |
| 873.3008-R009P | Full extension (with ball-bearing guide) with automatic retraction | 8 |
| 873.4008-R002P | Plastic bumpers | 2 |
| 873.4008-R005P | Plastic bumpers | 2 |
| 873.5008-R002P | Can holder for PERFORMANCEplus workshop trolley | 1 |
| 873.5008-R009P | Fixed castors for PERFORMANCEplus workshop trolley, incl. screws | 2 |
| 873.5008-R011P | Swivel castors with brakes, for PERFORMANCEplus workshop trolley, incl. screws | 2 |
| 873.5008-R014P | Roller set for PERFORMANCEplus workshop trolley, incl. screws | 1 |
| 873.7014-R003P | M6x12 screws for PERFORMANCEplus workshop trolley accessories | 14 |
| 873.7014-R004P | M8 screws for PERFORMANCEplus workshop trolley rollers (16 pcs.) | 1 |



873.7014-R101P...R200P
Replacement key for lock number xyz



873.7014-R201P...R300P
Lock with 2 keys for lock number xyz



873.3008-R008P
Full extension (with ball-bearing guide) with automatic retraction, right



873.3008-R009P
Full extension (with ball-bearing guide) with automatic retraction, left



873.5008-R009P
Fixed castors, incl. screws



873.5008-R011P
Swivel castors with brakes, incl. screws



873.5008-R014P
Roller set, incl. screws



873.0008-R003P
Stainless steel work surface



873.3008-R006P
Storage for work surface, including screw cover, usable on both sides



873.1008-R004P
Compartment with website and ball-bearing guide, 568x398x65 mm



873.1008-R003P
Compartment with ball-bearing guide, 568x398x65 mm



873.0008-R002P
Compartment with logo and ball-bearing guide, 568x398x145 mm



873.5008-R002P
Can holder, 310 mm



873.3008-R002P
Paper roll holder, 320 mm



873.4008-R005P
Plastic bumpers, front left, back right



873.4008-R002P
Plastic bumpers, front right, back left



873.7014-R004P
M8 screws (16 pcs.)



873.7014-R003P
M6x12 screw (1 pcs.)



873.0008-R001P
Body with handle



A thousand great parts for tough guys!

