

P15

Werkstattwagen

mit 397 Werkzeugen für 7 Schubladen

815.7397

DER STARKE KOMPAKTE

P15



Werkstattwagen P15
mit 8 Schubladen
873.1008



DUO Lock geniale Verschlusstechnik



8 Schubladen jeweils bis zu 50 kg belastbar



Stabiles **Kugellager**



Kunststoffoberfläche



Schloss abschließbar

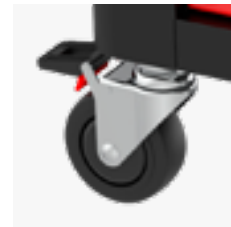

Antistatische Rollen mit Bremse



Integrierter **Kantenschutz**



Inklusive **Papierrollenhalter**



Inklusive **Dosenhalter**

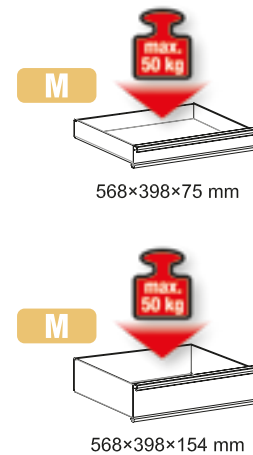
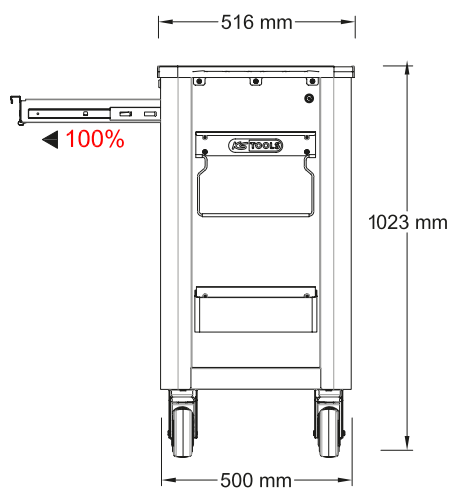
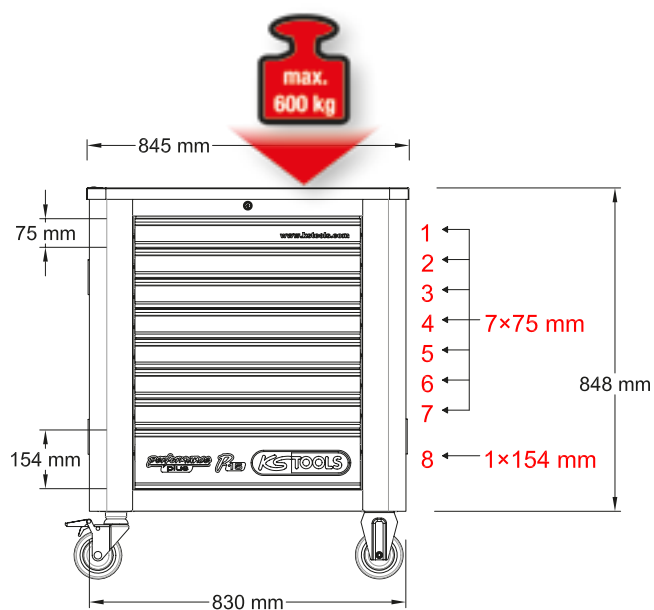

P15 Werkstattwagen

mit 397 Werkzeugen für 7 Schubladen

815.7397

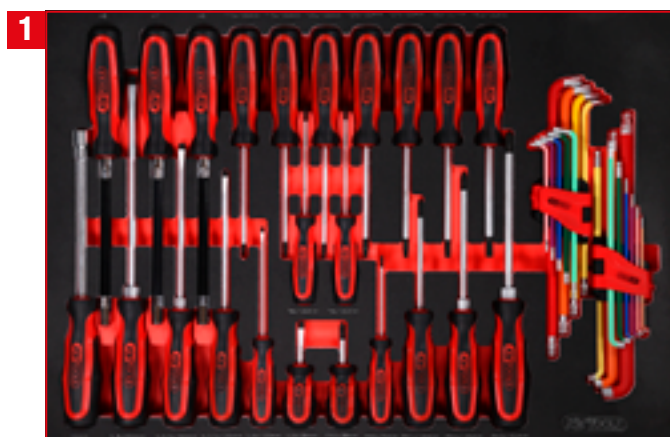

Schraubenschlüssel-Satz

811.0041



1/4" + 3/8" + 1/2" Steck-
schlüssel-Satz

811.0111



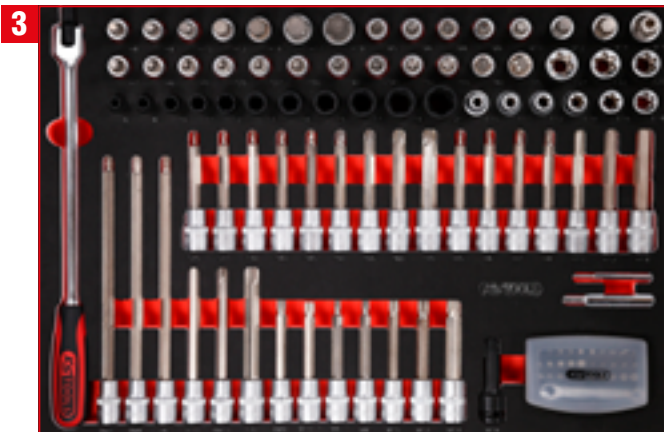

1/2" Bit-Stecknuss-Satz



811.1111



Schraubenschlüssel-Satz



811.1041



Zangen- / und Feilen-Satz



811.0019



Öl- / und Reifendienst-Satz



811.0043



Hammer- / und Meißel-Satz



811.0022

P 10

P 15

P 20

P 25

P 30

P 35

P 40

P 45

Einzel-Einlagen

Einzelteile

Zubehör

M Schraubendreher-Satz



568 x 398



P10



P10TC



P15



P20



P30



P35



P45

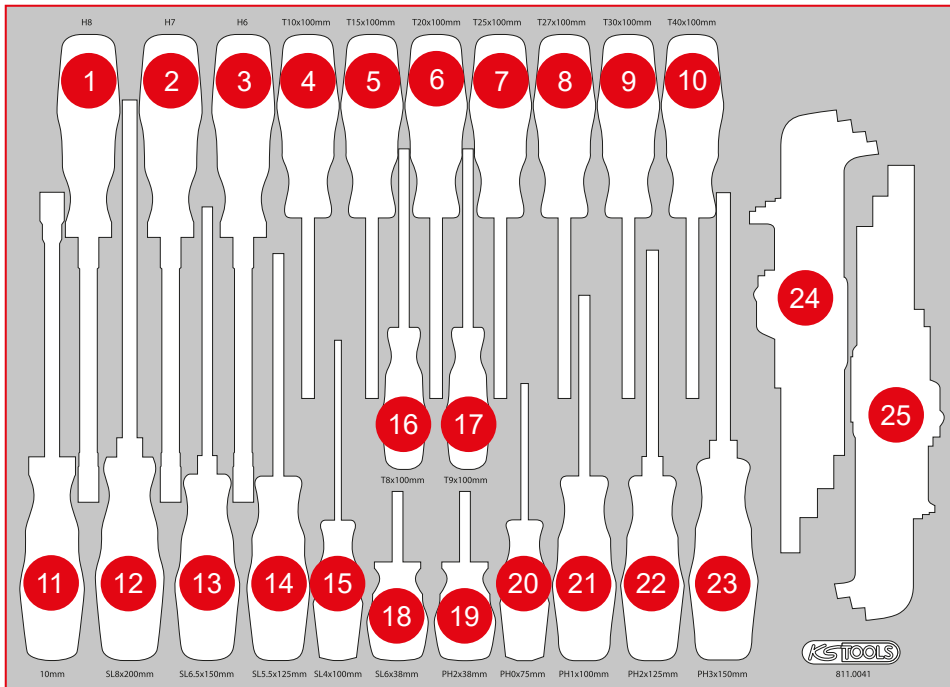
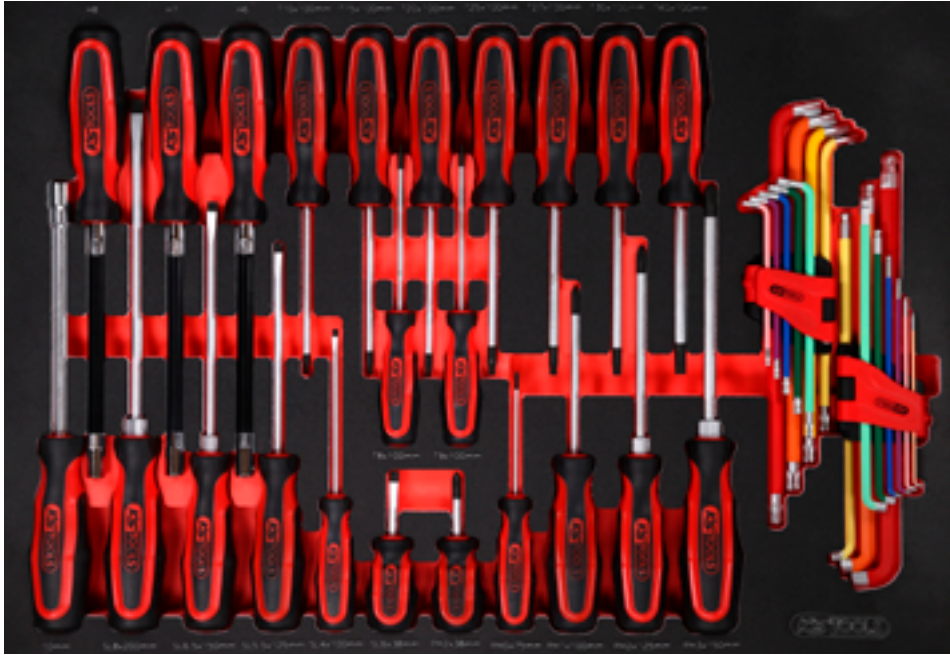

Pos.	Code	Bezeichnung	Teiligkeit
1	911.1128	ERGOTORQUE Stecknuss-Schraubendreher, 8 mm	1
2	159.1127	ERGOTORQUEplus Stecknuss-Schraubendreher, 7 mm	1
3	159.1126	ERGOTORQUEplus Stecknuss-Schraubendreher, 6 mm	1
4	159.1032	ERGOTORQUEplus Schraubendreher, T10	1
5	159.1033	ERGOTORQUEplus Schraubendreher, T15	1
6	159.1034	ERGOTORQUEplus Schraubendreher, T20	1
7	159.1035	ERGOTORQUEplus Schraubendreher, T25	1
8	159.1036	ERGOTORQUEplus Schraubendreher, T27	1
9	159.1037	ERGOTORQUEplus Schraubendreher, T30	1
10	159.1038	ERGOTORQUEplus Schraubendreher, T40	1
11	159.1208	ERGOTORQUEplus Stecknuss-Schraubendreher, 10 mm	1
12	159.1011	ERGOTORQUEplus Schlitz-Schraubendreher, 8 mm, 315 mm lang	1
13	159.1009	ERGOTORQUEplus Schlitz-Schraubendreher, 6,5 mm, 255 mm lang	1
14	159.1006	ERGOTORQUEplus Schlitz-Schraubendreher, 5,5 mm, 230 mm lang	1
15	159.1004	ERGOTORQUEplus Schlitz-Schraubendreher, 4 mm, 180 mm lang	1
16	159.1030	ERGOTORQUEplus Schraubendreher, T8	1
17	159.1031	ERGOTORQUEplus Schraubendreher, T9	1
18	159.1001	ERGOTORQUEplus Schlitz-Schraubendreher, kurz, 6 mm	1
19	159.1026	ERGOTORQUEplus Schraubendreher, kurz, PH2	1
20	159.1027	ERGOTORQUEplus Schraubendreher, PH0, 155 mm	1
21	159.1029	ERGOTORQUEplus Schraubendreher, PH1, 205 mm	1
22	159.1022	ERGOTORQUEplus Schraubendreher, PH2, 230 mm	1
23	159.1024	ERGOTORQUEplus Schraubendreher, PH3, 265 mm	1
24	151.4530	Kugelpf-Torx-Winkelstiftschlüssel-Satz, extra lang und 108° abgewinkelt, 9-tlg	9
25	151.4560	Kugelpf-Innensechskant-Winkelstiftschlüssel-Satz, 108° abgewinkelt, 9-tlg	9

M 1/4" + 3/8" + 1/2" Steckschlüssel-Satz



Pos.	Code	Bezeichnung	Teiligkeit
1	911.1462	1/4" Bit-Stecknuss Torx mit Stirnlochbohrung, TB10	1
2	911.1463	1/4" Bit-Stecknuss Torx mit Stirnlochbohrung, TB15	1
3	911.1464	1/4" Bit-Stecknuss Torx mit Stirnlochbohrung, TB20	1
4	911.1465	1/4" Bit-Stecknuss Torx mit Stirnlochbohrung, TB25	1
5	911.1466	1/4" Bit-Stecknuss Torx mit Stirnlochbohrung, TB27	1
6	911.1467	1/4" Bit-Stecknuss Torx mit Stirnlochbohrung, TB30	1
7	911.1468	1/4" Bit-Stecknuss Torx mit Stirnlochbohrung, TB40	1
8	911.1442	1/4" Bit-Stecknuss Torx, T10	1
9	911.1443	1/4" Bit-Stecknuss Torx, T15	1
10	911.1444	1/4" Bit-Stecknuss Torx, T20	1
11	911.1445	1/4" Bit-Stecknuss Torx, T25	1
12	911.1449	1/4" Bit-Stecknuss Torx, T27	1
13	911.1446	1/4" Bit-Stecknuss Torx, T30	1
14	911.1447	1/4" Bit-Stecknuss Torx, T40	1
15	911.1419	1/4" Bit-Stecknuss Schlitz, 5,5 mm	1
16	911.1416	1/4" Bit-Stecknuss, PH2	1
17	911.1436	1/4" Bit-Stecknuss Innensechskant, 3 mm	1

Pos.	Code	Bezeichnung	Teiligkeit
18	911.1437	1/4" Bit-Stecknuss Innensechskant, 4 mm	1
19	911.1438	1/4" Bit-Stecknuss Innensechskant, 5 mm	1
20	911.1439	1/4" Bit-Stecknuss Innensechskant, 6 mm	1
21	911.1440	1/4" Bit-Stecknuss Innensechskant, 7 mm	1
22	911.1701	1/4" Bit-Stecknuss, Fünfstern mit Stirnlochbohrung, TS10	1
23	911.1702	1/4" Bit-Stecknuss, Fünfstern mit Stirnlochbohrung, TS15	1
24	911.1703	1/4" Bit-Stecknuss, Fünfstern mit Stirnlochbohrung, TS20	1
25	911.1704	1/4" Bit-Stecknuss, Fünfstern mit Stirnlochbohrung, TS25	1
26	911.1705	1/4" Bit-Stecknuss, Fünfstern mit Stirnlochbohrung, TS27	1
27	911.1706	1/4" Bit-Stecknuss, Fünfstern mit Stirnlochbohrung, TS30	1
28	911.1707	1/4" Bit-Stecknuss, Fünfstern mit Stirnlochbohrung, TS40	1
29	917.3812	3/8" Sechskant-Stecknuss, 12 mm	1
30	917.3813	3/8" Sechskant-Stecknuss, 13 mm	1
31	917.3814	3/8" Sechskant-Stecknuss, 14 mm	1
32	917.3815	3/8" Sechskant-Stecknuss, 15 mm	1
33	917.3816	3/8" Sechskant-Stecknuss, 16 mm	1
34	917.3817	3/8" Sechskant-Stecknuss, 17 mm	1

Pos.	Code	Bezeichnung	Teiligkeit
35	917.3818	3/8" Sechskant-Stecknuss, 18 mm	1
36	917.3819	3/8" Sechskant-Stecknuss, 19 mm	1
37	917.3808	3/8" Sechskant-Stecknuss, 8 mm	1
38	917.3809	3/8" Sechskant-Stecknuss, 9 mm	1
39	917.3810	3/8" Sechskant-Stecknuss, 10 mm	1
40	917.3811	3/8" Sechskant-Stecknuss, 11 mm	1
41	917.1404	1/4" Sechskant-Stecknuss, 4 mm	1
42	917.1405	1/4" Sechskant-Stecknuss, 5 mm	1
43	917.1406	1/4" Sechskant-Stecknuss, 6 mm	1
44	917.1407	1/4" Sechskant-Stecknuss, 7 mm	1
45	917.1408	1/4" Sechskant-Stecknuss, 8 mm	1
46	917.1409	1/4" Sechskant-Stecknuss, 9 mm	1
47	917.1410	1/4" Sechskant-Stecknuss, 10 mm	1
48	917.1411	1/4" Sechskant-Stecknuss, 11 mm	1
49	917.1412	1/4" Sechskant-Stecknuss, 12 mm	1
50	917.1413	1/4" Sechskant-Stecknuss, 13 mm	1
51	917.1221	1/2" Sechskant-Stecknuss, 21 mm	1
52	917.1222	1/2" Sechskant-Stecknuss, 22 mm	1
53	917.1224	1/2" Sechskant-Stecknuss, 24 mm	1
54	917.1343	1/2" Sechskant-Stecknuss, 26 mm	1
55	917.1227	1/2" Sechskant-Stecknuss, 27 mm	1
56	917.1344	1/2" Sechskant-Stecknuss, 28 mm	1

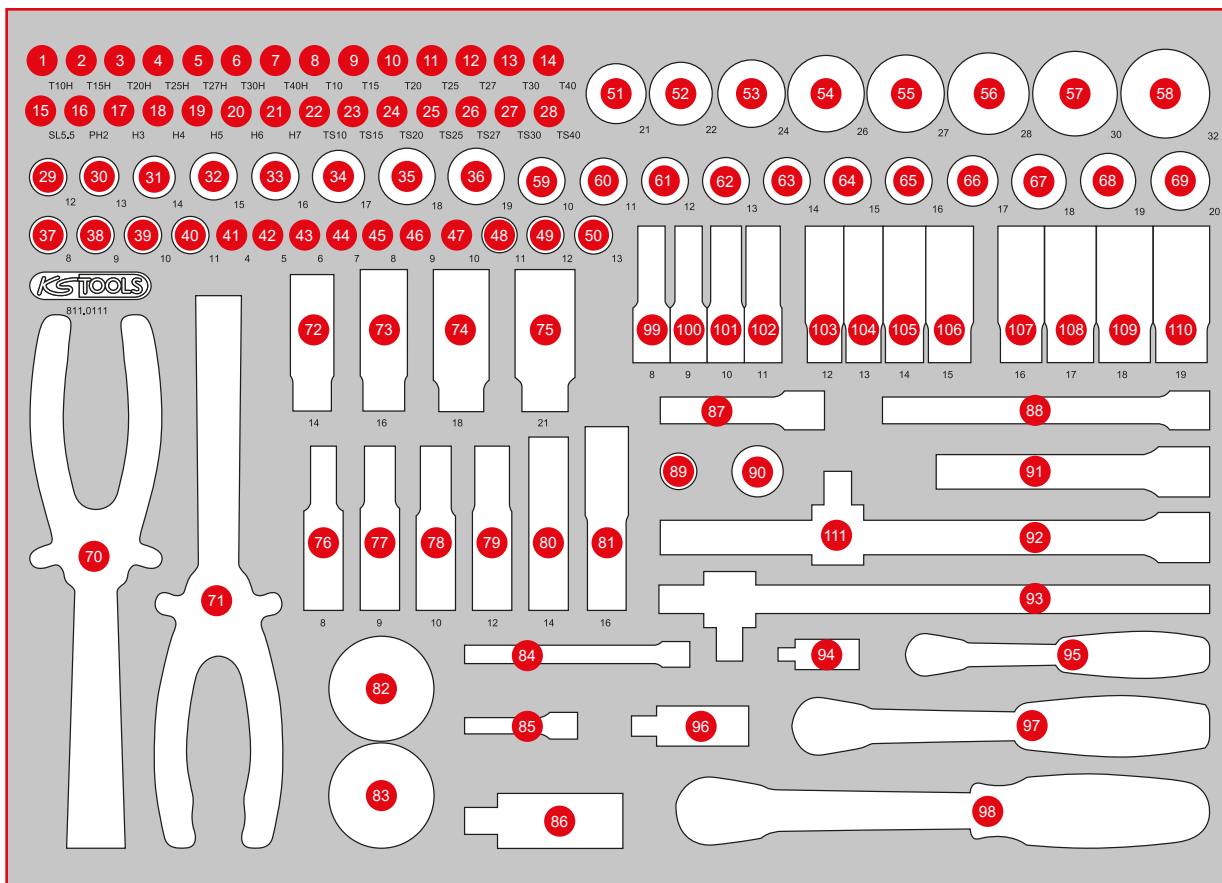

Pos.	Code	Bezeichnung	Teilligkeit	Pos.	Code	Bezeichnung	Teilligkeit	Pos.	Code	Bezeichnung	Teilligkeit
57	917.1230	1/2" Sechskant-Stecknuss, 30 mm	1	77	500.7302	3/8" Glühkerzen-Gelenknüsse, kurz, 75 mm, 9 mm	1	93	911.1204	1/2" T-Griff mit Gleitstück, 250 mm	1
58	917.1232	1/2" Sechskant-Stecknuss, 32 mm	1	78	500.7303	3/8" Glühkerzen-Gelenknüsse, kurz, 75 mm, 10 mm	1	94	911.1450	1/4" Kardangelenk	1
59	917.1210	1/2" Sechskant-Stecknuss, 10 mm	1	79	500.7304	3/8" Glühkerzen-Gelenknüsse, kurz, 75 mm, 12 mm	1	95	920.1490	1/4" SlimPOWER Umschaltknarre, 72 Zahn	1
60	917.1211	1/2" Sechskant-Stecknuss, 11 mm	1	80	500.7305	3/8" Glühkerzen-Gelenknüsse, kurz, 75 mm, 14 mm	1	96	911.3850	3/8" Kardangelenk	1
61	917.1212	1/2" Sechskant-Stecknuss, 12 mm	1	81	500.7306	3/8" Glühkerzen-Gelenknüsse, kurz, 75 mm, 16 mm	1	97	920.3890	3/8" SlimPOWER Umschaltknarre, 72 Zahn	1
62	917.1213	1/2" Sechskant-Stecknuss, 13 mm	1	82	914.1410	1/4" Mini-Hand-Umschaltknarre, 72 Zahn	1	98	920.1290	1/2" SlimPOWER Umschaltknarre, 72 Zahn	1
63	917.1214	1/2" Sechskant-Stecknuss, 14 mm	1	83	914.3810	3/8" Mini-Hand-Umschaltknarre, 72 Zahn	1	99	917.3828	3/8" Sechskant-Stecknuss, lang, 8 mm	1
64	917.1215	1/2" Sechskant-Stecknuss, 15 mm	1	84	911.1424	1/4" Verlängerung mit Antriebssechskant, 100 mm	1	100	917.3829	3/8" Sechskant-Stecknuss, lang, 9 mm	1
65	917.1216	1/2" Sechskant-Stecknuss, 16 mm	1	85	911.1423	1/4" Verlängerung mit Antriebssechskant, 50 mm	1	101	917.3830	3/8" Sechskant-Stecknuss, lang, 10 mm	1
66	917.1217	1/2" Sechskant-Stecknuss, 17 mm	1	86	911.1250	1/2" Kardangelenk	1	102	917.3831	3/8" Sechskant-Stecknuss, lang, 11 mm	1
67	917.1218	1/2" Sechskant-Stecknuss, 18 mm	1	87	911.3801	3/8" Verlängerung mit Rändelung, 75 mm	1	103	917.3832	3/8" Sechskant-Stecknuss, lang, 12 mm	1
68	917.1219	1/2" Sechskant-Stecknuss, 19 mm	1	88	911.3802	3/8" Verlängerung mit Rändelung, 150 mm	1	104	917.3833	3/8" Sechskant-Stecknuss, lang, 13 mm	1
69	917.1220	1/2" Sechskant-Stecknuss, 20 mm	1	89	911.3897	3/8" Reduzieradapter, 3/8" F x 1/4" M	1	105	917.3834	3/8" Sechskant-Stecknuss, lang, 14 mm	1
70	500.7310	Glühkerzenstecker-Zange, abgewinkelt, 235 mm	1	90	911.3826	3/8" Gleitstück/Reduzieradapter, 1/2" F x 3/8" M	1	106	917.3835	3/8" Sechskant-Stecknuss, lang, 15 mm	1
71	500.7330	Glühkerzenstecker-Zange, 265 mm	1	91	911.1202	1/2" Verlängerung, 125 mm	1	107	917.3836	3/8" Sechskant-Stecknuss, lang, 16 mm	1
72	911.3990	3/8" Spezial-Zündkerzen-Stecknuss, dünnwandig, 14 mm	1	92	911.1203	1/2" Verlängerung, 250 mm	1	108	917.3837	3/8" Sechskant-Stecknuss, lang, 17 mm	1
73	911.3804	3/8" Zündkerzen-Stecknuss, 16 mm	1					109	917.3838	3/8" Sechskant-Stecknuss, lang, 18 mm	1
74	911.3823	3/8" Zündkerzen-Stecknuss, 18 mm	1					110	917.3839	3/8" Sechskant-Stecknuss, lang, 19 mm	1
75	911.3805	3/8" Zündkerzen-Stecknuss, 21 mm	1					111	911.1207	3/8" Gleitstück/Vergrößerungsadapter, 3/8" F x 1/2" M	1
76	500.7301	3/8" Glühkerzen-Gelenknüsse, kurz, 75 mm, 8 mm	1								

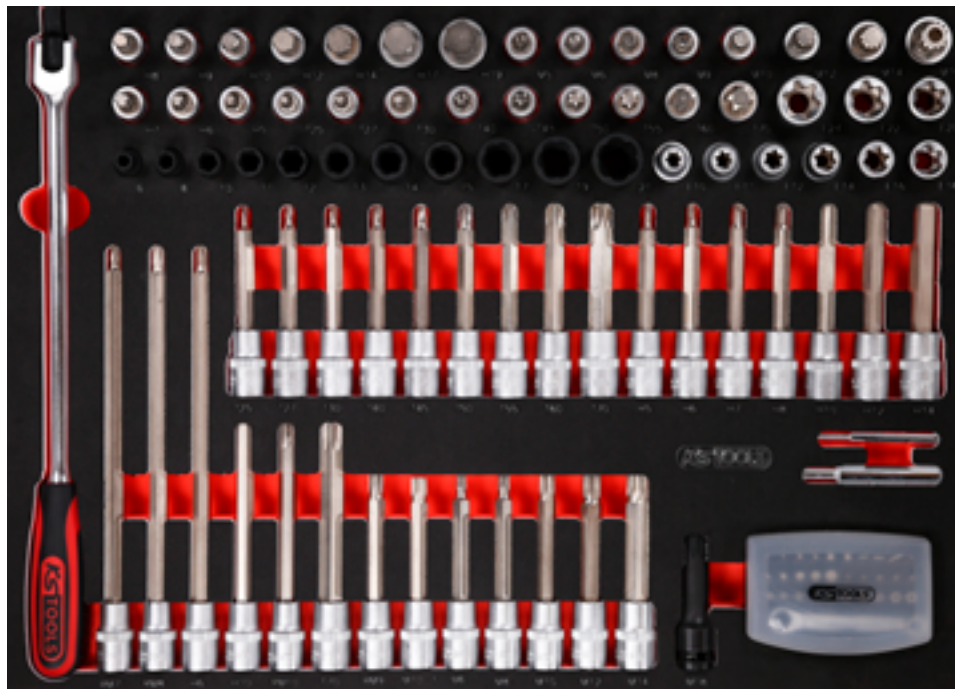
M 1/2" Bit-Stecknuss-Satz

568 x 398



P10



P10TC



P15



P20



P30



P35



P45

Pos.	Code	Bezeichnung	Teilligkeit
1	917.1455	1/2" Gelenk-Steckgriff	1
2	911.1308	1/2" Bit-Stecknuss Innensechskant, kurz, 8 mm	1
3	911.1309	1/2" Bit-Stecknuss Innensechskant, kurz, 9 mm	1
4	911.1310	1/2" Bit-Stecknuss Innensechskant, kurz, 10 mm	1
5	911.1312	1/2" Bit-Stecknuss Innensechskant, kurz, 12 mm	1
6	911.1314	1/2" Bit-Stecknuss Innensechskant, kurz, 14 mm	1
7	911.1317	1/2" Bit-Stecknuss Innensechskant, kurz, 17 mm	1
8	911.1319	1/2" Bit-Stecknuss Innensechskant, kurz, 19 mm	1
9	911.1340	1/2" Bit-Stecknuss XZN, M5, 55 mm	1
10	911.1341	1/2" Bit-Stecknuss XZN, M6, 55 mm	1
11	911.1342	1/2" Bit-Stecknuss XZN, M8, 55 mm	1
12	911.1313	1/2" Bit-Stecknuss XZN, M9, 55 mm	1
13	911.1343	1/2" Bit-Stecknuss XZN, M10, 55 mm	1
14	911.1344	1/2" Bit-Stecknuss XZN, M12, 55 mm	1
15	911.1345	1/2" Bit-Stecknuss XZN, M14, 55 mm	1

Pos.	Code	Bezeichnung	Teilligkeit
16	911.1348	1/2" Bit-Stecknuss XZN mit Stirnlochbohrung, M16, 55 mm	1
17	911.1307	1/2" Bit-Stecknuss Innensechskant, kurz, 7 mm	1
18	911.1306	1/2" Bit-Stecknuss Innensechskant, kurz, 6 mm	1
19	911.1305	1/2" Bit-Stecknuss Innensechskant, kurz, 5 mm	1
20	911.1362	1/2" Bit-Stecknuss Torx, T25	1
21	911.1363	1/2" Bit-Stecknuss Torx, T27	1
22	911.1364	1/2" Bit-Stecknuss Torx, T30	1
23	911.1365	1/2" Bit-Stecknuss Torx, T40	1
24	911.1366	1/2" Bit-Stecknuss Torx, T45	1
25	911.1367	1/2" Bit-Stecknuss Torx, T50	1
26	911.1368	1/2" Bit-Stecknuss Torx, T55	1
27	911.1369	1/2" Bit-Stecknuss Torx, T60	1
28	911.1370	1/2" Bit-Stecknuss Torx, T70	1
29	911.4326	1/2" Torx-E-Stecknuss, E24	1

Pos.	Code	Bezeichnung	Teilligkeit
30	911.4325	1/2" Torx-E-Stecknuss, E22	1
31	911.4324	1/2" Torx-E-Stecknuss, E20	1
32	913.1473	1/4" Spiral-Profil-Kraft-Stecknuss, 6 mm	1
33	913.1408	1/4" Spiral-Profil-Kraft-Stecknuss, 8 mm	1
34	913.1410	1/4" Spiral-Profil-Kraft-Stecknuss, 10 mm	1
35	913.1470	1/4" Spiral-Profil-Kraft-Stecknuss, 11 mm	1
36	913.1412	1/4" Spiral-Profil-Kraft-Stecknuss, 12 mm	1
37	913.1468	1/2" Spiral-Profil-Kraft-Stecknuss, 13 mm	1
38	913.1467	1/2" Spiral-Profil-Kraft-Stecknuss, 14 mm	1
39	913.1466	1/2" Spiral-Profil-Kraft-Stecknuss, 15 mm	1
40	913.1465	1/2" Spiral-Profil-Kraft-Stecknuss, 17 mm	1
41	913.1464	1/2" Spiral-Profil-Kraft-Stecknuss, 19 mm	1
42	913.1463	1/2" Spiral-Profil-Kraft-Stecknuss, 21 mm	1
43	911.4333	1/2" Torx-E-Stecknuss, E10	1
44	911.4334	1/2" Torx-E-Stecknuss, E11	1

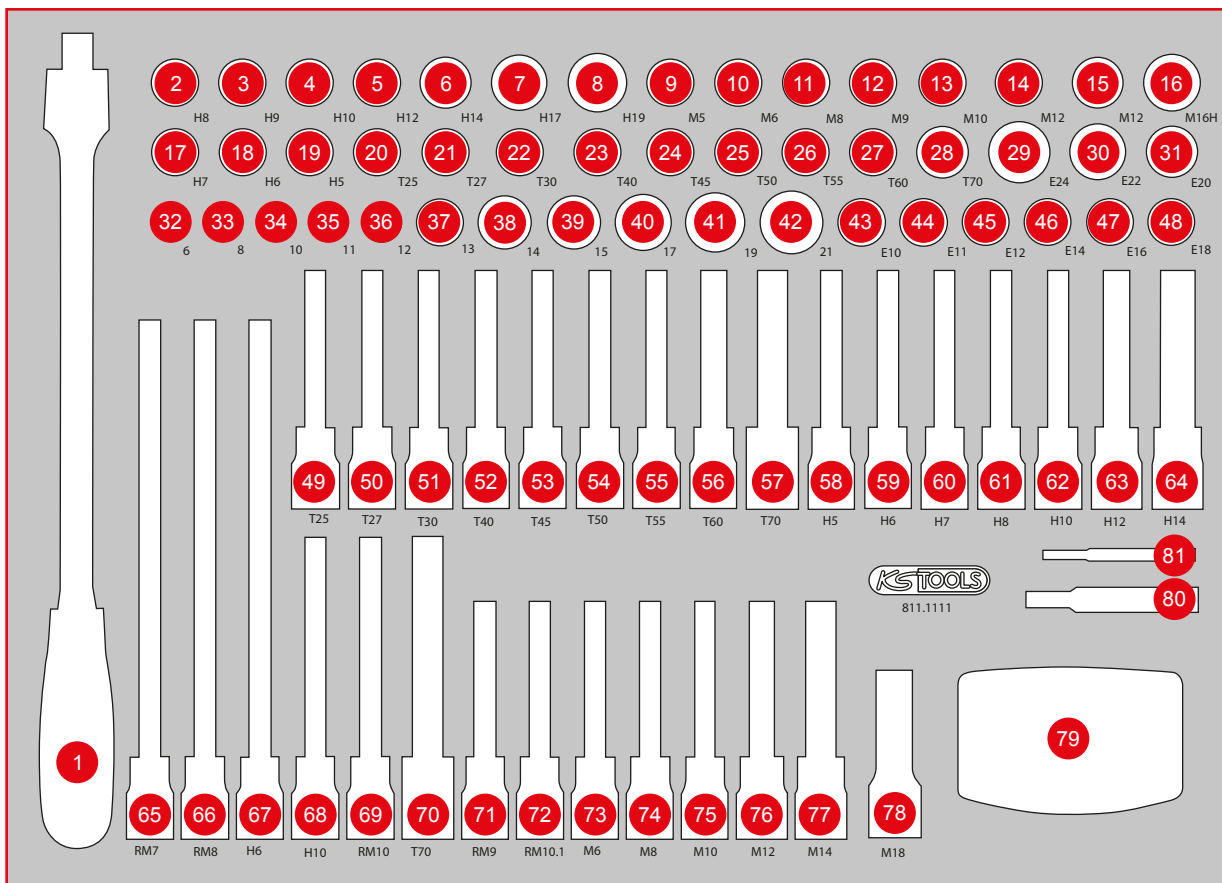

Pos.	Code	Bezeichnung	Teilligkeit	Pos.	Code	Bezeichnung	Teilligkeit	Pos.	Code	Bezeichnung	Teilligkeit
45	911.4335	1/2" Torx-E-Stecknuss, E12	1	60	911.1327	1/2" Bit-Stecknuss Innensechskant, lang, 7 mm	1	71	911.1925	1/2" Bit-Stecknuss für RIBE-Schrauben, M9, 110 mm	1
46	911.4336	1/2" Torx-E-Stecknuss, E14	1	61	911.1328	1/2" Bit-Stecknuss Innensechskant, lang, 8 mm	1	72	911.4554	1/2" Bit-Stecknuss für RIBE-Schrauben, M10.1, 110 mm	1
47	911.4322	1/2" Torx-E-Stecknuss, E16	1	62	911.1330	1/2" Bit-Stecknuss Innensechskant, lang, 10 mm	1	73	911.1351	1/2" Bit-Stecknuss XZN, M6, 110 mm	1
48	911.4323	1/2" Torx-E-Stecknuss, E18	1	63	911.1332	1/2" Bit-Stecknuss Innensechskant, lang, 12 mm	1	74	911.1352	1/2" Bit-Stecknuss XZN, M8, 110 mm	1
49	911.1522	1/2" Bit-Stecknuss Torx, lang, T25	1	64	917.1332	1/2" Bit-Stecknuss Innensechskant, lang, 14 mm	1	75	911.1353	1/2" Bit-Stecknuss XZN, M10, 110 mm	1
50	911.1523	1/2" Bit-Stecknuss Torx, lang, T27	1	65	911.1993	1/2" Bit-Stecknuss für RIBE-Schrauben, M7, 240 mm	1	76	911.1354	1/2" Bit-Stecknuss XZN, M12, 110 mm	1
51	911.1524	1/2" Bit-Stecknuss Torx, lang, T30	1	66	911.1994	1/2" Bit-Stecknuss für RIBE-Schrauben, M8, 240 mm	1	77	911.1355	1/2" Bit-Stecknuss XZN, M14, 110 mm	1
52	911.1525	1/2" Bit-Stecknuss Torx, lang, T40	1	67	911.5313	1/2" Bit-Stecknuss Innensechskant mit Kugelkopf, lang, 6 mm	1	78	515.1176	1/2" Kraft-Bit-Stecknuss XZN, lang, M18	1
53	911.1526	1/2" Bit-Stecknuss Torx, lang, T45	1	68	911.1960	1/2" Bit-Stecknuss Innensechskant, 10 mm, 140 mm	1	79	911.2055	1/4" TORSIONpower Bit-Satz, 31-tlg.	1
54	911.1527	1/2" Bit-Stecknuss Torx, lang, T50	1	69	911.1980	1/2" Bit-Stecknuss für RIBE-Schrauben, M10, 140 mm	1	80	913.1475	Austreibdorn, groß	1
55	911.1528	1/2" Bit-Stecknuss Torx, lang, T55	31	70	911.1942	1/2" Bit-Stecknuss Torx, T70, 140 mm	1	81	913.1474	Austreibdorn, klein	1
56	911.1529	1/2" Bit-Stecknuss Torx, lang, T60	1								
57	911.1517	1/2" Bit-Stecknuss Torx, lang, T70	1								
58	911.1325	1/2" Bit-Stecknuss Innensechskant, lang, 5 mm	1								
59	911.1326	1/2" Bit-Stecknuss Innensechskant, lang, 6 mm	1								

M Schraubenschlüssel-Satz

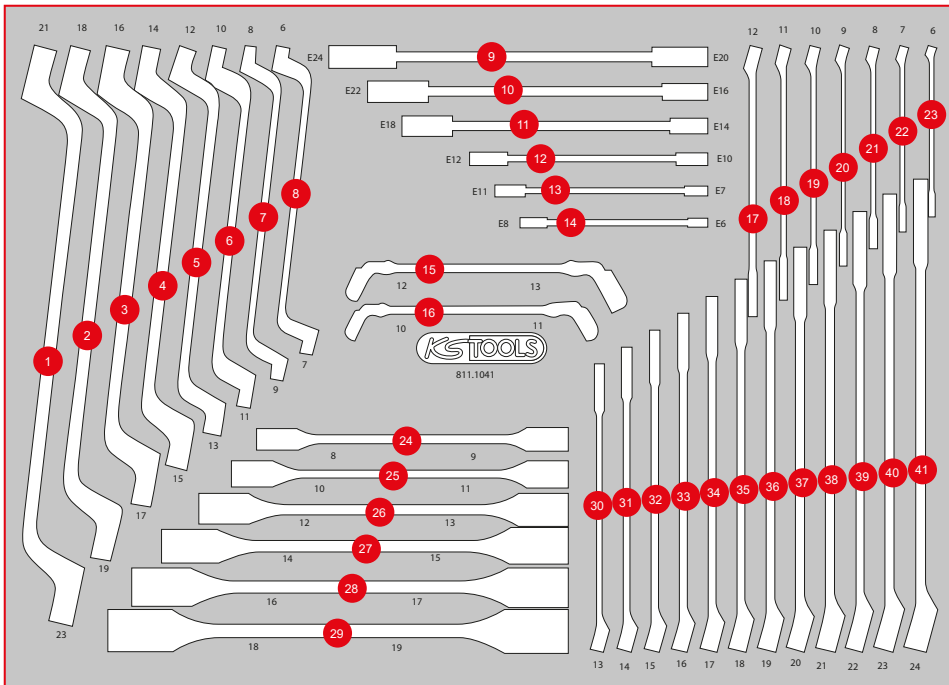

Pos.	Code	Bezeichnung	Teiligkeit
1	517.0815	Doppel-Ringschlüssel, gekröpft, 21 x 23 mm	1
2	517.0812	Doppel-Ringschlüssel, gekröpft, 18 x 19 mm	1
3	517.0810	Doppel-Ringschlüssel, gekröpft, 16 x 17 mm	1
4	517.0809	Doppel-Ringschlüssel, gekröpft, 14 x 15 mm	1
5	517.0807	Doppel-Ringschlüssel, gekröpft, 12 x 13 mm	1
6	517.0804	Doppel-Ringschlüssel, gekröpft, 10 x 11 mm	1
7	517.0802	Doppel-Ringschlüssel, gekröpft, 8 x 9 mm	1
8	517.0801	Doppel-Ringschlüssel, gekröpft, 6 x 7 mm	1
9	911.0376	Torx-E-Doppel-Ringschlüssel, E20 x E24	1
10	911.0375	Torx-E-Doppel-Ringschlüssel, E16 x E22	1
11	911.0374	Torx-E-Doppel-Ringschlüssel, E14 x E18	1
12	911.0373	Torx-E-Doppel-Ringschlüssel, E10 x E12	1
13	911.0372	Torx-E-Doppel-Ringschlüssel, E7 x E11	1
14	911.0371	Torx-E-Doppel-Ringschlüssel, E6 x E8	1
15	518.0529	Offener Doppel-Ringschlüssel 12 x 13	1
16	518.0528	Offener Doppel-Ringschlüssel 10 x 11	1
17	517.0612	Ringmaulschlüssel, abgewinkelt, 12 mm	1
18	517.0611	Ringmaulschlüssel, abgewinkelt, 11 mm	1
19	517.0610	Ringmaulschlüssel, abgewinkelt, 10 mm	1
20	517.0609	Ringmaulschlüssel, abgewinkelt, 9 mm	1
21	517.0608	Ringmaulschlüssel, abgewinkelt, 8 mm	1
22	517.0607	Ringmaulschlüssel, abgewinkelt, 7 mm	1
23	517.0606	Ringmaulschlüssel, abgewinkelt, 6 mm	1
24	517.0301	Doppel-Gelenkschlüssel, 8 x 9 mm	1
25	517.0302	Doppel-Gelenkschlüssel, 10 x 11 mm	1
26	517.0303	Doppel-Gelenkschlüssel, 12 x 13 mm	1
27	517.0304	Doppel-Gelenkschlüssel, 14 x 15 mm	1
28	517.0305	Doppel-Gelenkschlüssel, 16 x 17 mm	1
29	517.0306	Doppel-Gelenkschlüssel, 18 x 19 mm	1
30	517.0613	Ringmaulschlüssel, abgewinkelt, 13 mm	1
31	517.0614	Ringmaulschlüssel, abgewinkelt, 14 mm	1
32	517.0615	Ringmaulschlüssel, abgewinkelt, 15 mm	1
33	517.0616	Ringmaulschlüssel, abgewinkelt, 16 mm	1
34	517.0617	Ringmaulschlüssel, abgewinkelt, 17 mm	1
35	517.0618	Ringmaulschlüssel, abgewinkelt, 18 mm	1
36	517.0619	Ringmaulschlüssel, abgewinkelt, 19 mm	1
37	517.0620	Ringmaulschlüssel, abgewinkelt, 20 mm	1
38	517.0621	Ringmaulschlüssel, abgewinkelt, 21 mm	1
39	517.0622	Ringmaulschlüssel, abgewinkelt, 22 mm	1
40	517.0623	Ringmaulschlüssel, abgewinkelt, 23 mm	1
41	517.0624	Ringmaulschlüssel, abgewinkelt, 24 mm	1

811.0019

M Zangen- / und Feilen-Satz



Pos.	Code	Bezeichnung	Teiligkeit
1	157.0405	Dreikant-Feile, Form C, 200 mm, Hieb 2	1
2	157.0105	Halbrund-Feile, Form E, 200 mm, Hieb 2	1
3	157.0005	Flachfeile, Form B, 200 mm, Hieb 2	1
4	157.0205	Rund-Feile, Form F, 200 mm, Hieb 2	1
5	907.2166	Abbrechklingen 0,5 x 18 x 100 mm, Spender à 10 Stück	10
6	300.0114	Bandmaß mit Feststeller, schwarz-rot, 5 m, 19 mm	1
7	300.0510	Taschen-Messschieber 0-150 mm, 235 mm	1
8	300.0600	Fühlerlehre, 20 Blatt, 0,05-1 mm	1
9	907.2135	Universal-Abbrechklingen-Messer 18 mm	1
10	115.1033	Gripzange, 60 mm, 220 mm	1
11	115.2010	Wasserpumpenzange mit Druckknopfverstellung, 240 mm	1
12	500.1026	Außen-Sicherungszange, abgewinkelt, 160 mm	1
13	500.1029	Sicherungszange für Außensicherungsringe, 160 mm	1
14	500.1032	Innen-Sicherungszange, abgewinkelt, 160 mm	1
15	500.1035	Sicherungszange für Innensicherungsringe, 160 mm	1
16	115.1012	ERGOTORQUE Diagonal-Seitenschneider, 160 mm	1
17	115.1021	ERGOTORQUE Kombinationszange, 180 mm	1
18	115.1019	ERGOTORQUE Flachrundzange, gebogen, 210 mm	1
19	115.1024	ERGOTORQUE Telefonzange, 200 mm	1

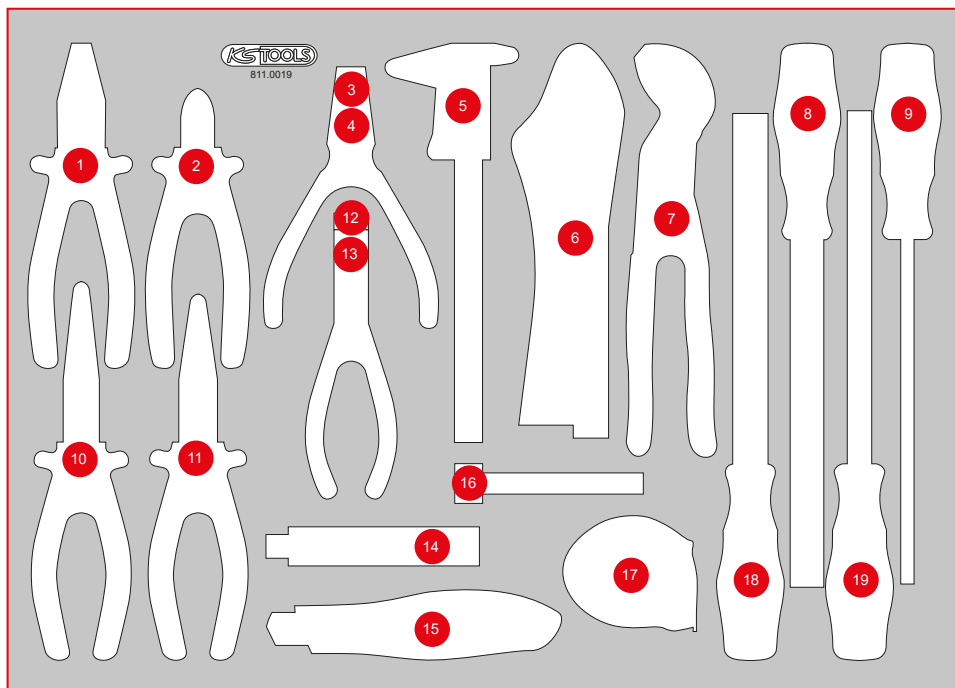

M Öl- / und Reifendienst-Satz



TLG
43

568 x 398



Pos.	Code	Bezeichnung	Teilligkeit	Pos.	Code	Bezeichnung	Teilligkeit	Pos.	Code	Bezeichnung	Teilligkeit
1	150.2222	Universal Bremskolben Rückstellwürfel, 3/8"	1	7	150.9114	Öldienst-Bit-Stecknuss für Innenvierkant-Schrauben 11 mm	1	13	150.9123	3/8" Öldienst-Bit-Stecknuss 8 mm für Innenvierkant-Schrauben	1
2	150.9120	3/8" Öldienst-Bit-Stecknuss 3/8" für Innenvierkant-Schrauben	1	8	150.9116	3/8" Öldienst-Bit-Stecknuss 12 mm für Innenvierkant-Schrauben	1	14	150.9124	3/8" Öldienst-Bit-Stecknuss 9 mm für Innenvierkant-Schrauben	1
3	150.9119	3/8" Öldienst-Bit-Stecknuss 5/16" für Innenvierkant-Schrauben	1	9	150.9117	3/8" Öldienst-Bit-Stecknuss 13 mm für Innenvierkant-Schrauben	1	15	150.9125	3/8" Öldienst-Bit-Stecknuss 10 mm für Innenvierkant-Schrauben	1
4	150.9111	Öldienst-Bit-Stecknuss für Innenvierkant-Schrauben 7 mm	1	10	150.9118	3/8" Öldienst-Bit-Stecknuss 14 mm für Innenvierkant-Schrauben	1	16	150.9126	3/8" Öldienst-Bit-Stecknuss 12 mm für Innenvierkant-Schrauben	1
5	150.9112	Öldienst-Bit-Stecknuss für Innenvierkant-Schrauben 8 mm	1	11	150.9122	3/8" Öldienst-Bit-Stecknuss 10 mm für Innenvierkant-Schrauben	1	17	150.9127	3/8" Öldienst-Bit-Stecknuss 14 mm für Innenvierkant-Schrauben	1
6	150.9113	Öldienst-Bit-Stecknuss für Innenvierkant-Schrauben 10 mm	1	12	150.9121	3/8" Öldienst-Bit-Stecknuss 10 mm für Innenvierkant-Schrauben	1	18	150.9128	3/8" Öldienst-Bit-Stecknuss 17 mm für Innenvierkant-Schrauben	1

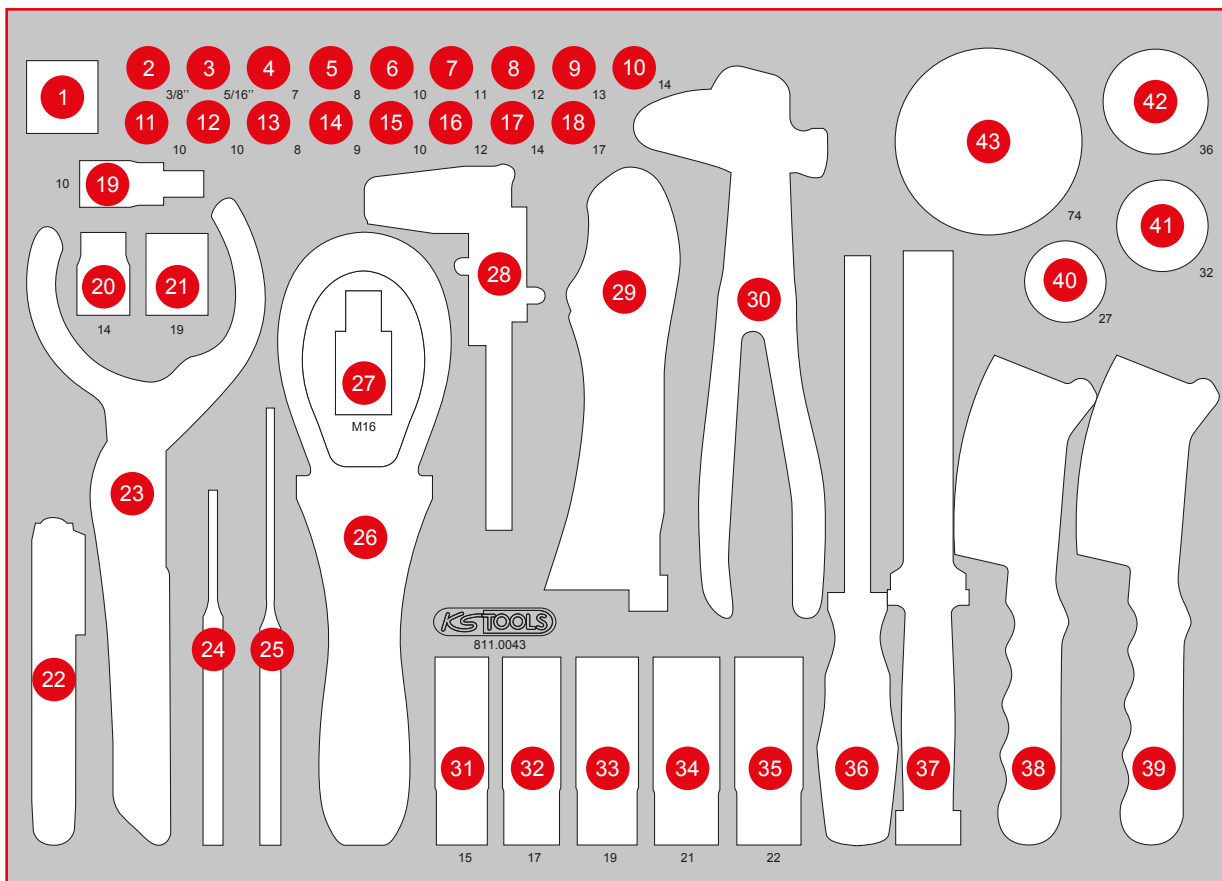

Pos.	Code	Bezeichnung	Teilligkeit	Pos.	Code	Bezeichnung	Teilligkeit	Pos.	Code	Bezeichnung	Teilligkeit
19	150.2153	1/2" Bremssattel Bit-Stecknuss Innenfünfkant, 10 mm	1	27	911.1348	1/2" Bit-Stecknuss XZN mit Stirnlochbohrung, M16, 55 mm	1	36	157.0960	Bremssattel-Feile extra schmal, 270 mm	1
20	150.2154	1/2" Bremssattel Stecknuss 5-kant, 14 mm	1	28	300.0535	Bremsscheiben Messschieber 0-60 mm, 162 mm	1	37	911.8132	Schonmeißel, 22 mm	1
21	150.2155	1/2" Bremssattel Stecknuss 5-kant, 19 mm	1	29	115.1175	Maul-Gripzange mit Drahtschneider, 175 mm	1	38	201.2335	Bremssattel-Drahtbürste 2-reihig, gerade, 225 mm	1
22	150.2199	Bremsschlagtestster	1	30	150.2025	Reifendienstzange, 250 mm	1	39	201.2340	Bremssattel-Drahtbürste 2-reihig, gewellt, 225 mm	1
23	150.9317	Ölfilter-Zange, 50-125 mm	1	31	515.0991	SlimPOWER 1/2" Impact-Stecknuss, 15 mm	1	40	150.9217	3/8" Universal Ölfilterschlüssel, SW 27 mm	1
24	156.0114	Splintentreiber, 8-kant, hochglanz verchromt, Ø 5 mm	1	32	515.0992	SlimPOWER 1/2" Impact-Stecknuss, 17 mm	1	41	150.9218	3/8" Universal Ölfilterschlüssel, SW 32 mm	1
25	156.0122	Splintentreiber, x L, 8-kant, hochglanz verchromt, Ø 4 mm	1	33	515.0993	SlimPOWER 1/2" Impact-Stecknuss, 19 mm	1	42	150.9219	3/8" Universal Ölfilterschlüssel, SW 36 mm	1
26	155.5005	Ölfilterschlüssel, Ø 65-105 mm	1	34	515.0994	SlimPOWER 1/2" Impact-Stecknuss, 21 mm	1	43	150.9215	3/8" Ölfilterschlüssel, SW 74,2 mm, 14 Flächen	1
				35	515.0995	SlimPOWER 1/2" Impact-Stecknuss, 22 mm	1				

811.0022

M Hammer- / und Meißel-Satz

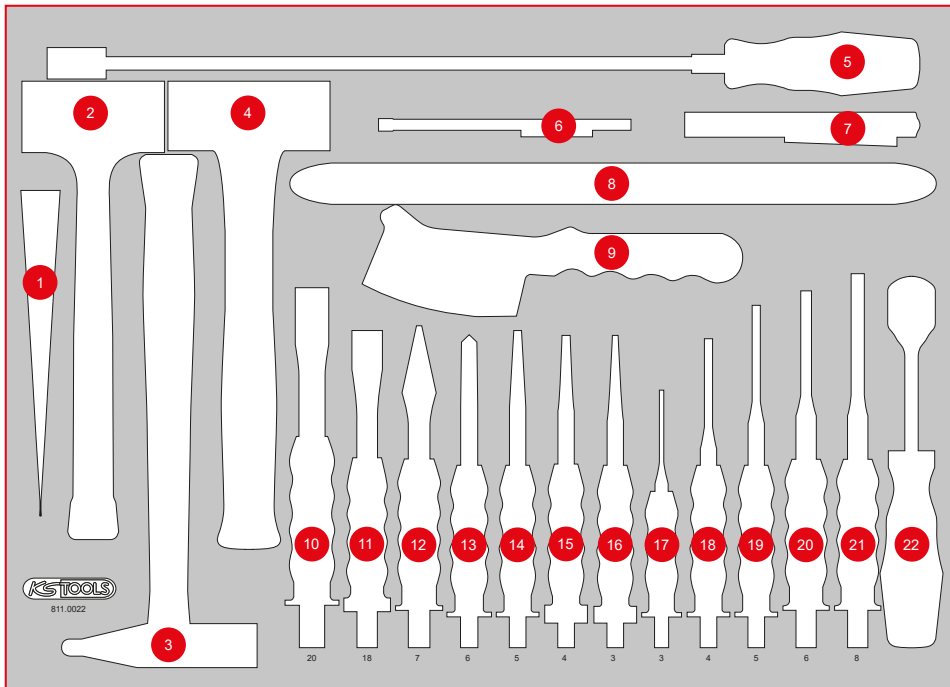

Pos.	Code	Bezeichnung	Teiligkeit
1	911.8138	Zierleisten-Kunststoffkeil, 195 mm x B = 30 mm	1
2	140.5252	Rückschlagfreier Schonhammer, 400 g	1
3	142.1402	Schlosser Hammer mit Fiberglasstiel, 400 g	1
4	142.5101	Fäustel mit Fiberglasstiel, 1000 g	1
5	550.1025	Flexibler Magnethalter, 510 mm, Ø Kopf = 15 mm	1
6	550.1001	2 in 1 Teleskop-Magnethalter mit Waschlinsen-Reinigungs- und Einstellwerkzeug, 150 - 675 mm	1
7	150.4370	perfectLight Taschenlampe 85 Lumen	1
8	911.8146	Reifen-Montierhebel, 370 mm	1
9	201.2335	Bremssattel-Drahtbürste 2-reihig, gerade, 225 mm	1
10	156.0241	Flachmeißel mit Handschutzgriff, 8-kant, 20 mm	1
11	156.0254	Flachmeißel mit Handschutzgriff, 8-kant, 18 mm	1
12	156.0242	Kreuzmeißel, 7 mm, 8-kant	1
13	156.0243	Körner, 10 mm, 8-kant	1
14	156.0244	Durchtreiber, Ø 5 mm, konisch	1
15	156.0238	Durchtreiber mit Handschutzgriff, 8-kant, konisch, 4 mm	1
16	156.0237	Durchtreiber mit Handschutzgriff, 8-kant, konisch, 3 mm	1
17	156.0231	Durchtreiber, Ø 3 mm, zylindrisch	1
18	156.0232	Splintentreiber, Ø 4 mm, zylindrisch	1
19	156.0233	Durchtreiber, Ø 5 mm, zylindrisch	1
20	156.0234	Durchtreiber, Ø 6 mm, zylindrisch	1
21	156.0235	Durchtreiber, Ø 8 mm, zylindrisch	1
22	907.2232	Dichtungsschaber, 25 x 200 mm	1

P15

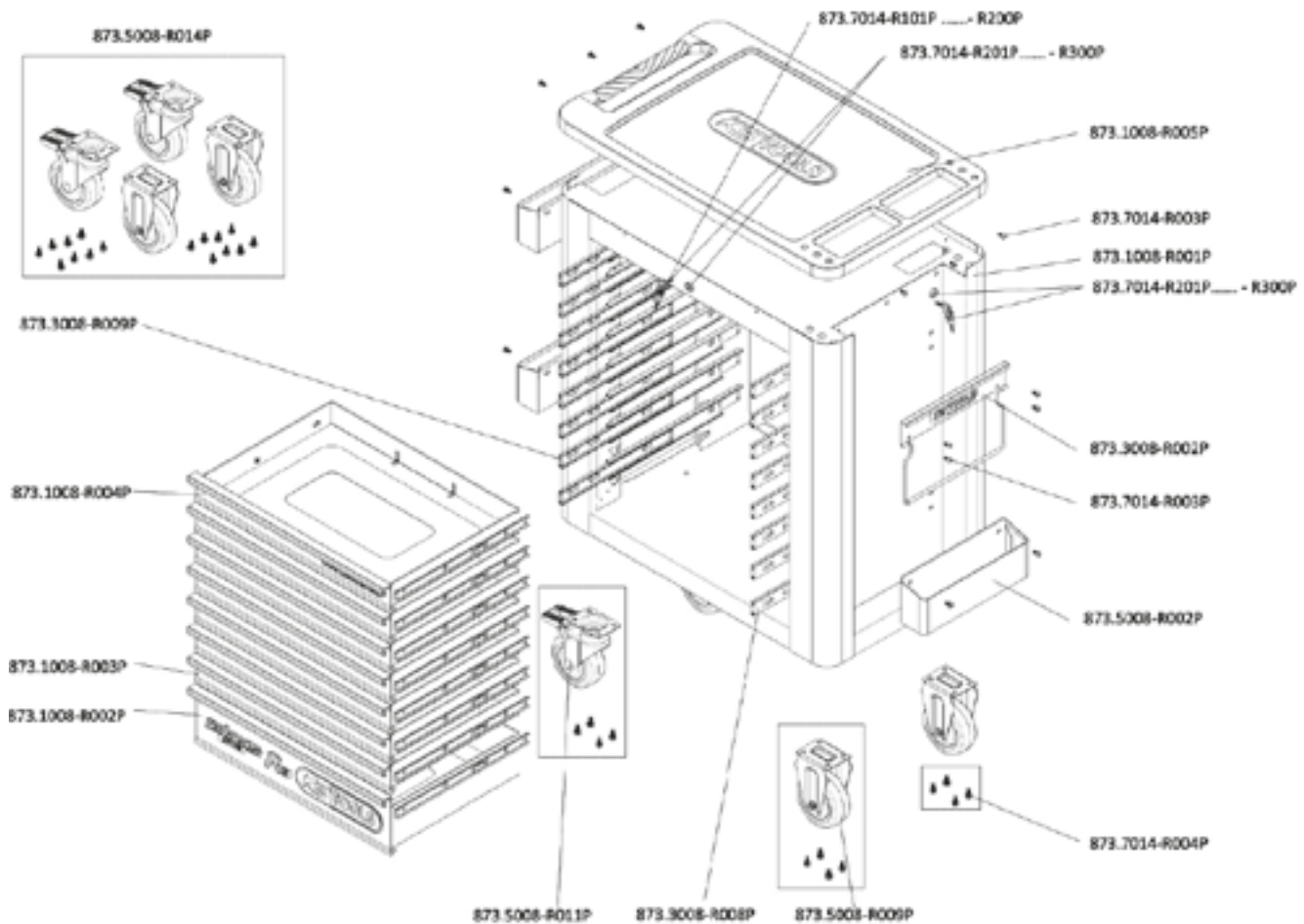

EINZELTEIL-LISTE

Art.-Nr.	Beschreibung	Menge
873.7014-R101P...	Ersatzschlüssel für Schloß Nummer xyz zu PERFORMANCEplus Werkstattwagen	2
873.7014-R201P...	Schloß mit 2 Schlüsseln zu PERFORMANCEplus Werkstattwagen Schloß-Nr. xyz	2
873.1008-R001P	Korpus zu Werkstattwagen P15	1
873.1008-R002P	Schublade mit Logo und Kugelführung zu Werkstattwagen P15, 568x398x145 mm	1
873.1008-R003P	Schublade mit Kugelführung zu Werkstattwagen P10/P10TC/P15, 568x398x65 mm	6
873.1008-R004P	Schublade mit Website und Kugelführung zu Werkstattwagen P10/P15, 568x398x65 mm	1
873.1008-R005P	Kunststoff Arbeitsplatte mit Handgriff zu Werkstattwagen P15	1
873.3008-R002P	Papierrollen-Halter zu PERFORMANCEplus Werkstattwagen P10/P15/P25	1
873.3008-R008P	Vollauszug Kugelführung mit autom. Rückzug	8
873.3008-R009P	Vollauszug Kugelführung mit autom. Rückzug	8
873.5008-R002P	Dosen-Halter zu PERFORMANCEplus Werkstattwagen P10/P15/P25/P35	3
873.5008-R009P	Laufrolle starr für PERFORMANCEplus Werkstattwagen inkl. Schrauben	2
873.5008-R011P	Lenkrolle mit Bremse zu PERFORMANCEplus Werkstattwagen inkl. Schrauben	2
873.5008-R014P	Rollen-Satz zu PERFORMANCEplus Werkstattwagen inkl. Schrauben	1
873.7014-R003P	Schraube M6x12 für PERFORMANCEplus Werkstattwagen-Zubehör	16
873.7014-R004P	Schraube M8 für Rollen zu PERFORMANCEplus Werkstattwagen (16 Stück)	1



873.7014-R101P...R200P
Ersatzschlüssel für Schlossnum-
mer xyz



873.7014-R201P...R300P
Schloss inklusive 2 Schlüssel,
Schlossnummer xyz



873.3008-R008P
Laufschiene mit Selbsteinzug,
für Schublade, rechts



873.3008-R009P
Laufschiene mit Selbsteinzug,
für Schublade, links



873.5008-R009P
Laufrolle, starr, inklusive
Schrauben

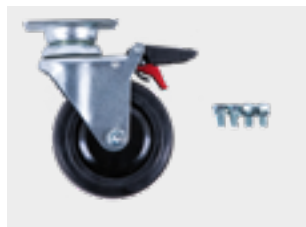

873.5008-R011P
Lenkrolle mit Feststellbremse
inklusive Schrauben



873.5008-R014P
Rollensatz, 2 x Lenkrolle + 2 x
Laufrolle, inklusive Schrauben



873.1008-R005P
Kunststoff-Arbeitsplatte mit Griff



873.1008-R004P
Schublade mit Website, inklusive
Laufschiene, H=65 mm, B=568
mm x T=398 mm



873.1008-R003P
Schublade, inklusive Laufschiene,
H=65 mm, B=568 mm x T=398 mm



873.1008-R002P
Schublade mit Logo, inklusive
Laufschiene, H=145 mm,
B=568 mm x T=398 mm



873.5008-R002P
Dosenhalter inklusive Schrauben,
B = 310 mm



873.3008-R002P
Papirollenhalter inklusive
Schrauben, B = 320 mm



873.7014-R004P
Schraube, M8, mit Unterlegschei-
be, 16 Stück



873.7014-R003P
Schraube, M6 x 12 mm, 1 Stück



873.1008-R001P
Stahlkorpus



Unersetzlich ist nur
die Qualität!