

179 N-6

179 N-7

179 N-8

179 N-9

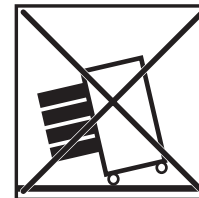
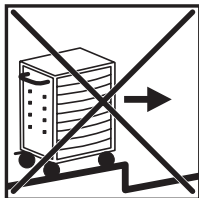
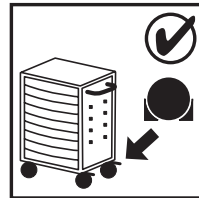

179 N-6

179 N-7

179 N-8

179 N-9

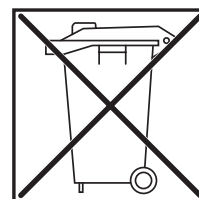
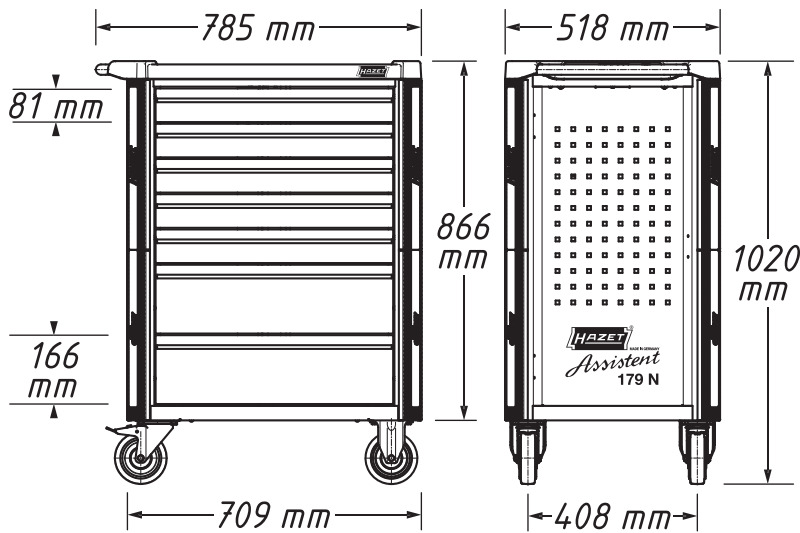
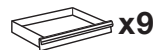
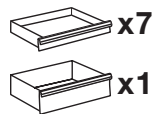
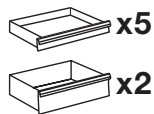
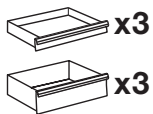

125113