

167-3 S

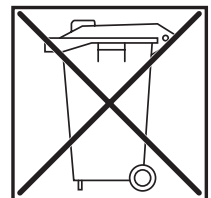
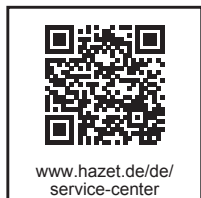
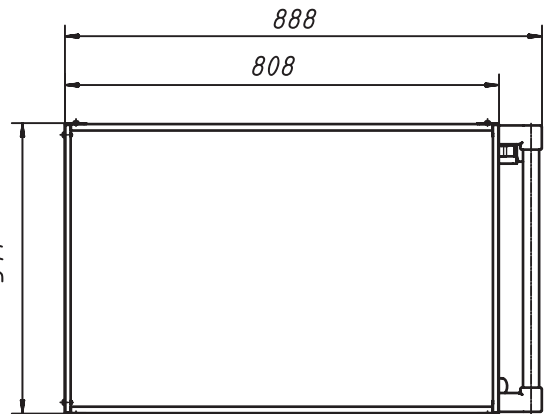
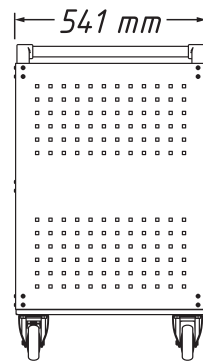
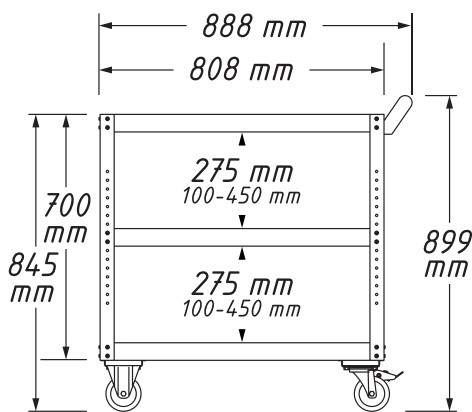
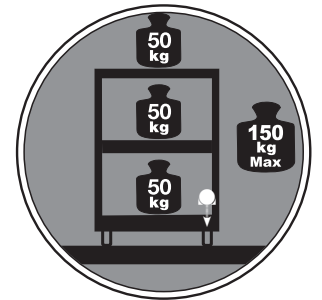
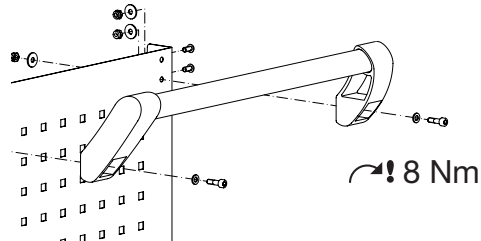
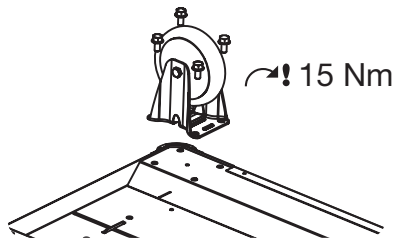
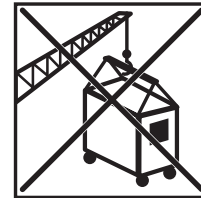
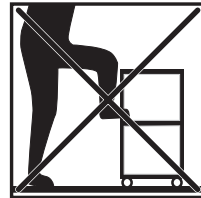
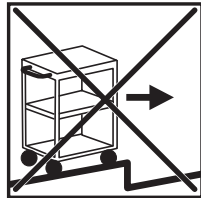
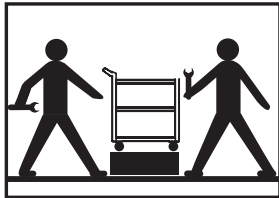
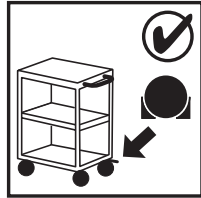
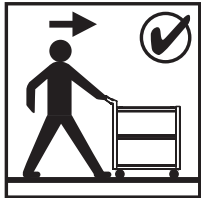

223991

223991 IV: cb/pdf